

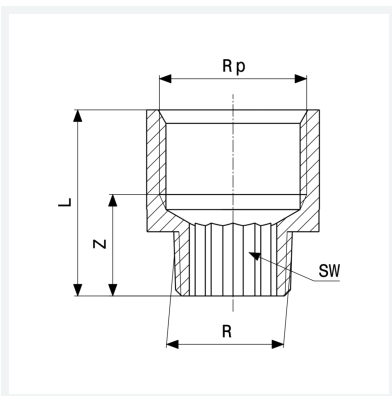

Reduzierstück
- R-Gewinde, Rp-Gewinde
- rund
Modell 3242

Artikel 441 128



Eigenschaften

Außengewinde kegelig	R	1/8
Innengewinde zylindrisch	Rp	1/4
Z-Maß	Z	14 mm
Länge	L	25 mm
Schlüsselweite	SW	6 mm
Gewicht	23,3 g	
Volumen	24,864 cm ³	
Werkstoff	Rotguss oder Siliziumbronze	