



Fabricant français  
depuis 1964

[www.gys.fr](http://www.gys.fr)



# MAGNETICS POSITIONERS

For more comfort during your welding process



## Magnetic positioners for welder comfort

### MAGNETIC P 15.90

- Angle : 60° & 90°
- $\downarrow$  max 15 kg
- $\downarrow$  mm 100 x 73 x 12
- $\downarrow$  x2



047044

### MAGNETIC P 16.90

- Angle : 45°, 90° & 135°
- $\downarrow$  max 16 kg
- $\downarrow$  mm 45 x 32 x 28
- $\downarrow$  x4

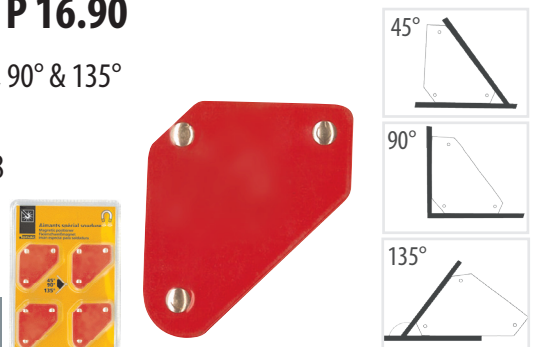

044180

### MAGNETIC P 19.90

- Angle : 45°, 90° & 135°
- $\downarrow$  max 19 kg
- $\downarrow$  mm 156 x 102 x 20
- $\downarrow$  x1

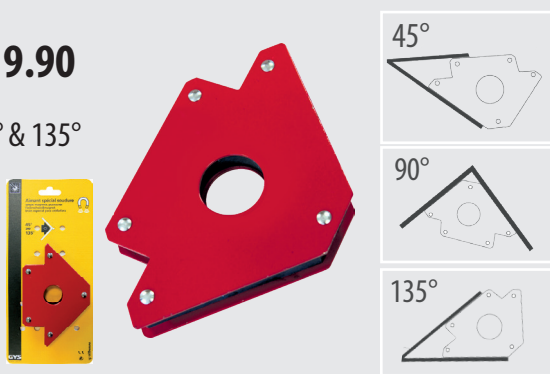

044203



### MAGNETIC P 20.180

- $\downarrow$  0 > 180°
- $\downarrow$  max 20 kg
- $\downarrow$  mm 204 x 86 x 28
- $\downarrow$  x1



044302

### MAGNETIC D50.90 DUAL Switchable

- Angle : 90°
- $\downarrow$  max 50 kg
- $\downarrow$  mm 148 x 148 x 38
- $\downarrow$  x1



047051

## MAGNETIC D36.90

Switchable

- Angle : 45°, 90° & 135°
- $\overset{\text{max}}{\text{kg}}$  30 kg
- $\overset{\text{mm}}{\text{mm}}$  111 x 95 x 25
- $\text{x1}$

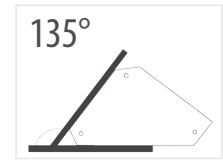
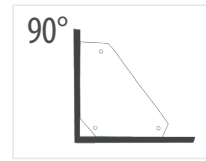
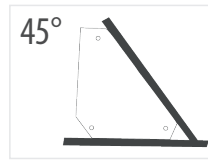

044197

## MAGNETIC D50.90

Switchable

- Angle : 90°
- $\overset{\text{max}}{\text{kg}}$  50 kg
- $\overset{\text{mm}}{\text{mm}}$  71 x 60 x 48
- $\text{x1}$

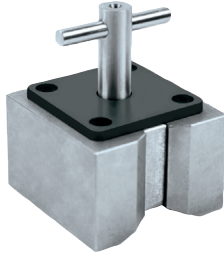

047075

## MAGNETIC D70.90 M

Switchable

- Angle : 90°
- $\overset{\text{max}}{\text{kg}}$  70 kg
- $\overset{\text{mm}}{\text{mm}}$  48 x 32 x 70
- $\text{x1}$



047068

## MAGNETIC D70.120M

Switchable

- Angle : 45°, 60°, 75°, 90°, 105° & 135°
- $\overset{\text{max}}{\text{kg}}$  70 kg
- $\overset{\text{mm}}{\text{mm}}$  111 x 55 x 80
- $\text{x1}$



047082

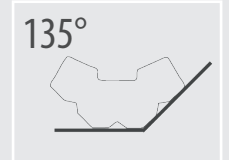
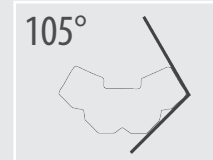
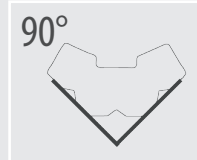
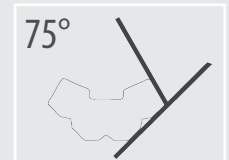
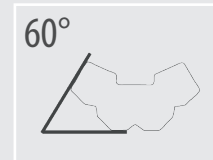
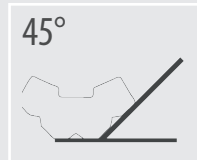

## MAGNETIC D70.135M

Switchable

- Angle : 45°, 75°, 90°, 105° & 135°
- $\overset{\text{max}}{\text{kg}}$  70 kg
- $\overset{\text{mm}}{\text{mm}}$  99 x 55 x 80
- $\text{x1}$



047099

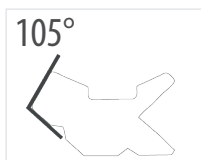
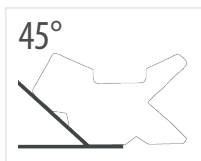



Created in 1964, GYS are a family-owned company with over 700 employees around the world. Built around continuous investment in research and development and the acquisition of knowledge, the company is now a major player in the design and manufacture of welding machines, battery chargers and car body repair equipment.

 **GYS France (HQ)**  
1, rue de la Croix des Landes  
CS 54159  
53941 Saint-Berthevin - Cedex  
Laval - France  
Fax : (+33) 2 43 68 35 21  
[www.gys.fr](http://www.gys.fr) / E-mail : [contact@gys.fr](mailto:contact@gys.fr)