

BENNING

Operating manual

Translation of the German original version

BENNING MM 2-1 / MM 2-2 / MM 2-3

5241 / 10/2023 en



Legal notice

Notes concerning the documentation

Ensure that the applicable documentation is used for this product. For safe handling, knowledge that is provided in these instructions is required.

The product may only be handled while following this documentation, particularly the safety instructions and warnings it contains. The personnel must be qualified for the respective task and have the capability to recognise risks and prevent possible dangers.

Manufacturer and holder of rights

BENNING Elektrotechnik und Elektronik GmbH & Co. KG
Münsterstraße 135 – 137
46397 Bocholt
Germany
Phone: +49 2871 / 93-0
E-Mail: duspol@benning.de
Internet: www.benning.de
Commercial register Coesfeld HRA No. 4661

Copyright

© 2022, BENNING Elektrotechnik und Elektronik GmbH & Co. KG

All rights reserved.

This document – particularly all of the contents, texts, photographs and graphics that it contains – are protected by copyright.

No part of this documentation or the associated contents may be reproduced or edited, copied or distributed using electronic media in any form (printed, photocopied or using any other method) without express written permission.

Disclaimer

The contents of the documentation has been checked to ensure that it corresponds to the hardware and software described. Nevertheless, deviations cannot be ruled out, so Benning cannot guarantee complete correspondence. The contents of this documentation are checked at regular intervals, and any corrections that are needed are contained in the versions that follow.

General non-discrimination

Benning is aware of the importance of language with regard to the gender equality and endeavors to take this into account at all times. To improve readability, we have refrained from consistently using differentiating formulations.

Table of contents

1	Introduction	7
1.1	General notes.....	7
1.2	History.....	8
1.3	Service & support.....	9
2	Safety	10
2.1	Warning system.....	10
2.2	Standards applied.....	10
2.3	Symbols used.....	11
2.4	Intended use.....	12
2.5	Special types of risks.....	14
3	Scope of delivery	15
4	Device description	17
4.1	Device structure.....	17
4.2	Functions.....	19
4.2.1	“SELECT” key.....	19
4.2.2	“RANGE” key.....	20
4.2.3	“MIN MAX” key.....	20
4.2.4	“HOLD” key.....	20
4.2.5	“VoltSense” key.....	21
4.2.6	“Hz” key.....	21
4.2.7	Jack control (MM 2-2 / MM 2-3).....	21
4.3	Measuring ranges.....	22
4.3.1	Voltage ranges.....	22
4.3.2	Current ranges (MM 2-2 / MM 2-3).....	23
4.3.3	Resistance ranges.....	24
4.3.4	Continuity test.....	24
4.3.5	Diode test.....	24
4.3.6	Capacitance ranges (MM 2-2 / MM 2-3).....	25
4.3.7	Frequency ranges.....	25
4.3.8	Temperature ranges (MM 2-3).....	26
5	Operation	27
5.1	Requirements for tests and measurements.....	27
5.2	Connecting the safety measuring lines.....	28
5.3	Voltage or frequency measurement.....	29
5.4	Current or frequency measurement.....	30
5.5	Resistance measurement or continuity testing.....	31
5.6	Capacitance measurement or diode testing.....	32

5.7	Temperature measurement.....	34
5.8	Voltage indicator	35
5.8.1	Non-contact phase testing	35
5.8.2	External conductor or phase testing.....	37
6	Maintenance	38
6.1	Maintenance schedule	38
6.2	Making the device free of voltage	38
6.3	Cleaning the device.....	39
6.4	Replacing the batteries	40
6.5	Calibrating the device.....	41
6.6	Replacing the fuse	41
7	Technical data.....	42
8	Disposal and environmental protection	43
	Index	44

Table of figures

Figure 1	BENNING CFlex 1	15
Figure 2	BENNING TA 1	15
Figure 3	BENNING TA 2	16
Figure 4	BENNING TA 3	16
Figure 5	Ø 4 mm measuring lines with 2 mm measuring probe	16
Figure 6	BENNING MM 2-1 / MM 2-2 / MM 2-3 device structure.....	17
Figure 7	Rotary switch	18
Figure 8	Digital display.....	18
Figure 9	Voltage or frequency measurement.....	29
Figure 10	Current or frequency measurement.....	30
Figure 11	Resistance measurement or continuity test.....	31
Figure 12	Capacitance measurement or diode testing	32
Figure 13	Temperature measurement	34
Figure 14	Non-contact phase testing	35
Figure 15	External conductor or phase testing	37
Figure 16	Battery replacement (exemplary).....	40

List of tables

Table 1	History.....	8
Table 2	Symbols on the device.....	11
Table 3	Symbols used in the operating manual.....	11
Table 4	Selecting a function	19
Table 5	AC voltage ranges (V-AC)	22
Table 6	DC voltage ranges (V-DC).....	23
Table 7	AC ranges (A-AC).....	23
Table 8	DC ranges (A-DC).....	23
Table 9	Resistance ranges (Ω).....	24
Table 10	Continuity test	24
Table 11	Diode test.....	24
Table 12	Capacitance ranges (F)	25
Table 13	Mains frequency ranges (Hz).....	25
Table 14	Temperature ranges ($^{\circ}\text{C}$ / $^{\circ}\text{F}$)	26
Table 15	Maintenance schedule	38
Table 16	Technical data	42

1 Introduction

The TRUE RMS digital multimeter BENNING MM 2-1 / MM 2-2 / MM 2-3 described here (in the following only referred to as “device”) is intended for testing in electric circuits with a nominal voltage up to a maximum of 600 V-AC or 600 V-DC. The device enables you to perform the following tests and measurements:

- DC and AC voltage measurement
- DC and AC current measurement (MM 2-2 / MM 2-3)
- Resistance measurement
- Diode and continuity test
- Capacitance measurement (MM 2-2 / MM 2-3)
- Frequency measurement
- Temperature measurement (MM 2-3)

Further information

<http://tms.benning.de/mm2-x>



On the Internet, you will find the following additional information directly at the specified link or at www.benning.de (product search):

- Operating manual of the device in several languages
- Further information depending on the device (e. g. brochures, technical reports, FAQs)

1.1 General notes

Target group

This operating manual is intended for the following groups of people:

- Qualified electricians and electrotechnically trained personnel

Required basic knowledge

To understand these operating manual, you will need general knowledge of testing and measuring equipment. Moreover, you will need basic knowledge of the following issues:

- General electrical engineering

Purpose of the operating manual

This operating manual describes the device and provides you information about how to handle it.

Keep this operating manual in a safe place for later use. Read this operating manual before handling the device and follow the instructions.

NOTE

Disclaimer of liability

Please make sure that any person using the device has read and understood the instructions of this operating manual before handling the device and that the instructions are adhered to in all points. Non-observance of this operating manual might result in product damage, property damage and/or personal injury.

Benning assumes no liability for damage and malfunctions resulting from the failure to observe the instructions in this operating manual.

The devices are subject to continuous further development. Benning reserves the right to make changes to the device's design, configuration and technology. The information in this operating manual corresponds to the state of technical knowledge at the time of printing. For this reason, no claims for certain device characteristics can be derived from the contents of this operating manual.

Information in this operating manual can be changed at any time without prior notice. Benning is not obligated to make amendments to this operating manual or to keep it up to date.

Direct any technical questions to Technical Support [▶ page 9].

Trademarks

All trademarks used are the property of their respective owners, even if they are not separately marked as such.

1.2 History

Release number	Amendments
07/2022	<ul style="list-style-type: none"> Initial release
10/2023	<ul style="list-style-type: none"> Adaptation to amended normative requirements of IEC / DIN EN 61010-2-033:2021 + A11:2021

Table 1: History

1.3 Service & support

Please contact your specialty retailer or the BENNING Service Center for any repair or service work that might be required.

Technical Support

Please contact our Technical support for technical questions on handling the device.

Phone:	+49 2871 93-555
Fax:	+49 2871 93-6555
E-Mail:	helpdesk@benning.de
Internet:	www.benning.de

Returns management

Easily and conveniently use the BENNING returns portal for a quick and smooth returns processing:

<https://www.benning.de/service-de/retourenabwicklung.html>

Phone:	+49 2871 93-554
E-Mail:	returns@benning.de

Return address

BENNING Elektrotechnik und Elektronik GmbH & Co. KG
Retourenmanagement
Robert-Bosch-Str. 20
D - 46397 Bocholt

2 Safety

2.1 Warning system

This operating manual contains notes that must be taken into consideration for your personal safety and in order to avoid injuries and damage to property. Warnings about your personal safety and to prevent personal injuries are marked with a warning triangle. Warnings on sole prevention of material damage are shown without a warning triangle. The warnings are shown in descending order depending on the hazard level as follows.



⚠ DANGER

Extremely dangerous situation for humans

If you do not pay attention to this warning, irreversible or deadly injuries will occur.



⚠ WARNING

Hazard to humans

If you do not pay attention to this warning, irreversible or deadly injuries could occur.



⚠ CAUTION

Minor hazard to humans

If you do not pay attention to this warning, minor or moderate injuries could occur.



NOTICE

Danger to property, not to persons

If you do not pay attention to this warning, material damage could occur.

If multiple hazard levels occur, the warning for the highest respective hazard level will be used. In addition, a warning about personal injuries can also include a warning about material damage.

2.2 Standards applied

The device has been built and tested in compliance with the following standards and has left the factory in perfectly safe condition.

- IEC / DIN EN 61010-1 (VDE 0411-1)
- IEC / DIN EN 61010-2-033 (VDE 0411-2-033)
- IEC / DIN EN 61010-031 (VDE 0411-031)

2.3 Symbols used

Symbols on the device











Symbol	Meaning
	Please observe the information provided in this operating manual in order to avoid dangers.
	Warning of electrical danger! Please observe the information provided in this operating manual in order to avoid dangers.
CAT III	Measuring category III is applicable to testing and measuring circuits connected to the distribution circuit of the low-voltage mains installation of a building.
CAT IV	Measuring category IV is applicable to testing and measuring circuits connected to the feeding point of the low-voltage mains installation of a building.
	The device complies with EU directives.
	The device complies with directives applicable in Great Britain.
	At the end of product life, dispose of the unserviceable device via appropriate collecting facilities provided in your community.
	The device is provided with protective insulation (protection class II).
	This symbol indicates the inserted batteries.
	Please observe the operating manual.
	(DC) direct voltage or direct current
	(AC) alternating voltage or alternating current
	Earth (voltage to earth)

Table 2: Symbols on the device

Symbols used in the operating manual



Symbol	Meaning
	General warning
	Warning of electric voltage!

Table 3: Symbols used in the operating manual

2.4 Intended use

Only use the device within the framework of the corresponding technical data. Any operating conditions that deviate from this shall be considered as improper use. Solely the user of the device shall be liable for any resulting damage.

Please note the following:

- In case of improper use, the liability and warranty claims become void. Solely the user of the device shall be liable for any damage resulting from improper use. Uses not complying with the intended use include e. g.:
 - Use of components, accessories, spare or replacement parts that have not been released and approved for the respective application by Benning
 - Non-observance, manipulation, changes or misuse of the operating manual or the instructions and notes contained therein
 - Any form of misuse of the device
 - Any use other than or beyond that described in this operating manual
- Warranty and liability claims are generally excluded if the damage is the result of force majeure.
- If any prescribed services are not performed regularly or not on time, according to the manufacturer's specifications during the warranty period, a decision about a warranty claim can only be made once the findings are available.

Direct any questions to Technical Support [▶ page 9].

Using the device

Please observe the following basic obligations when using the device:

- The device may only be used in a technically perfect and safe condition. Always check the device for damages before using it.
- The personnel must be qualified for the respective task.
- Observe relevant regulations on occupational safety and health as well as those on environmental protection.
- The device may only be used inside buildings and in dry environments.
- Do not use the device in potentially explosive environments.
- Use the device only in electric circuits up to overvoltage category CAT III with a conductor for a maximum of 600 V or up to overvoltage category CAT IV with a conductor for a maximum of 300 V to earth.
- Use suitable (approved) safety measuring lines. For measurements in electric circuits of overvoltage category CAT III or IV, the protruding conductive part of a contact tip of the safety measuring line must not be longer than 4 mm. Before measuring, attach the enclosed protective caps onto the contact tips (marked with CAT III and CAT IV).
- In order to prevent any danger due to incorrect measurements, replace discharged batteries immediately.
- In order to prevent any danger, replace a defective fuse immediately.

**⚠ WARNING****Dangerous voltage**

Danger to life or serious injury is possible due to contact with high electric voltage in case of incorrect operation.

- Do not touch the bare measuring probe tips of the safety measuring lines or the bare contacts of the optional alligator clips. Only touch the safety measuring lines in the area intended for your hands.
- Connect the safety measuring lines to the correspondingly marked measuring jacks of the device and check them for tight fit.
- Only use approved safety measuring lines.
- Attach the protective caps to the contact tips of the safety measuring lines (circuits of overvoltage category CAT III or IV).
- When disconnecting the measuring circuit, first remove the live safety measuring line (phase) and then the neutral safety measuring line from the measuring point.

**⚠ WARNING****Opening the device**

Danger to life or serious injury is possible due to contact with high electric voltage when opening the device. The device might get damaged.

- Make sure that the device is free of voltage before opening the battery compartment or housing.
- Do not open the device (except for the battery compartment and replacing a fuse).
- Please contact your specialty retailer or the returns management for any repairs [▶ page 9].

Securing the device

If the device is not in a technically perfect and operationally safe condition, safe operation is no longer guaranteed. Make sure that the following measures are taken:

- Switch off the device.
- Remove the device from the measuring point.
- Secure the device against unintentional operation.

The following characteristics indicate that safe operation is no longer guaranteed:

- The device (housing or safety measuring lines) shows visible damage or is damp/wet.
- The insulation of the safety measuring lines is damaged.
- The device does not work properly in compliance with regulations (e. g. errors during measurements).
- The device shows recognisable consequences of prolonged storage under inadmissible conditions.
- The device shows recognisable consequences of extraordinary stress due to transport.

2.5 Special types of risks



DANGER

Bare conductors or main line carriers

Danger to life or serious injury is possible due to contact with high electric voltage when working with bare conductors or main line carriers.

- Please observe relevant regulations on occupational safety and health.
- If necessary, use appropriate protective equipment.



WARNING

Dangerous voltage

Danger to life or serious injury is possible due to contact with high electric voltage when working on live components or equipment. Even low voltages from 30 V-AC and 60 V-DC on can be dangerous to human life!

- Please observe relevant regulations on occupational safety and health.
- If necessary, use appropriate protective equipment.

3 Scope of delivery

The scope of delivery of the device includes the following components:

- 1 x TRUE RMS digital multimeter BENNING MM 2-1 (item no.: 044691), BENNING MM 2-2 (item no.: 044692) or BENNING MM 2-3 (item no.: 044693)
- Silicone safety measuring lines (item no.: 10231315):
 - 1 x silicone safety measuring line (red, l = 1.0 m)
 - 1 x silicone safety measuring line (black, l = 1.0 m)
- 1 x wire temperature sensor of type K (l = 93 cm ±3 cm, item no.: 10231316) (MM 2-3)
- 1 x compact protective pouch (item no.: 010913)
- 2 x 1.5 V micro batteries (AAA / IEC R03)
- 1 x fuse (F 11 A, 1 000 V, 20 kA, item no.: 10218772, integrated into the device for initial assembly) (MM 2-2 / MM 2-3)
- 1 x operating manual

Optional accessories

- Flexible AC current transformer BENNING CFlex 1 (item no.: 044068)
AC range: 30 A / 300 A / 3 000 A



Figure 1: BENNING CFlex 1

- Set of safety measuring lines BENNING TA 1 (item no.: 044124)
Ø 4 mm alligator clips, 2-piece, red / black, professional version, CAT III 1 000 V, 36 A



Figure 2: BENNING TA 1

- Set of safety measuring lines BENNING TA 2 (item no.: 044125)
Set of Ø 4 mm measuring lines, 6-piece, red / black, professional version, consisting of:
 - Measuring lines (silicone) (CAT III 1 000 V)
 - Test probes (4 mm measuring probe, CAT II 1 000 V)
 - Alligator clips (CAT III 1 000 V)



Figure 3: BENNING TA 2

- Set of safety measuring lines BENNING TA 3 (item no.: 044126)
Set of Ø 4 mm measuring lines, 8-piece, red / black, professional version, CAT III 1 000 V, consisting of:
 - Measuring lines (silicone)
 - Test probes (slender measuring probe)
 - Grabber clips
 - Alligator clips



Figure 4: BENNING TA 3

- Set of Ø 4 mm safety measuring lines with 2 mm measuring probe (item no.: 044146)
Ø 4 mm measuring lines, 2-piece, red / black, l = 1.40 m, with 2 mm measuring probe, CAT IV 600 V / CAT III 1 000 V (with protective caps), CAT II 1 000 V (without protective caps)



Figure 5: Ø 4 mm measuring lines with 2 mm measuring probe

4 Device description

4.1 Device structure



Figure 6: BENNING MM 2-1 / MM 2-2 / MM 2-3 device structure

1	Digital display	2	Jack for V, Ω , diode, capacitance (MM 2-2 / MM 2-3), temperature (MM 2-3)
3	COM jack	4	Jack for A (MM 2-2 / MM 2-3)
5	Rotary switch	6	Function keys
7	Protective rubber holster		

Rear panel of the device

- Foldable stand (on the protective rubber holster)
- Battery compartment
- Holders for engaging the safety measuring lines (on the protective rubber holster)
You can store the safety measuring lines by wrapping them around the protective rubber holster and engaging the measuring probes and the gripping areas onto the protective rubber holster in a protective way.
- Notes and information about the device
- Serial number (label)

Rotary switch

You can set the desired test or measurement by means of the rotary switch.

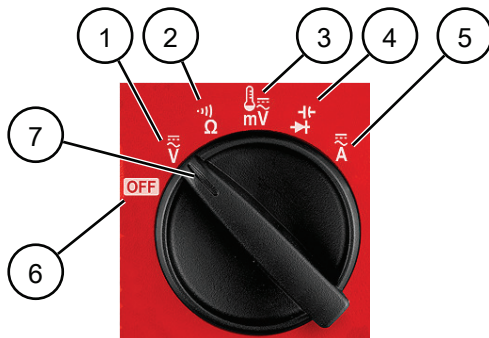

Figure 7: Rotary switch

1	Voltage measurement (V)	2	Resistance measurement (Ω) or continuity test
3	Voltage measurement (mV) or temperature measurement (MM 2-3)	4	Diode test or capacitance measurement (MM 2-2 / MM 2-3)
5	Current measurement (A) (MM 2-2 / MM 2-3)	6	Device switched off (OFF)
7	Setting of the rotary switch		

Digital display

The digital display is divided into different sections:

- Display of the currently set functions and units
- Display range: 4-digit liquid crystal display (LCD) with a font size of 19 mm and decimal points. The highest display value is 6 000 digits.
- Battery status: Indicates the empty state of charge of the batteries. When the symbol appears, the batteries are discharged.
- Polarity display (automatic): Indicates a polarity contrary to the jack definition with “-”.

The maximum nominal measuring rate of the device is 5 measurements per second for the digital display. For reading the values in dark lighting conditions, the digital display is provided with a background lighting [► page 20].

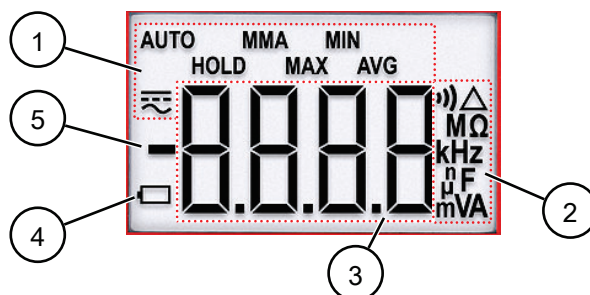

Figure 8: Digital display

1	Display of functions	2	Display of units and functions
3	Display range	4	Battery status
5	Polarity		

4.2 Functions

Use the rotary switch to switch the device on (desired measuring function) or off ("OFF"). The device confirms each operation of keys with an acoustic signal.

Smart automatic switch-off (APO, Auto-Power-Off)

The device switches off automatically after approx. 32 minutes. To switch the device back on, press the "HOLD" or "VoltSense" key or first set the rotary switch to switch position "OFF" and then set the desired measuring function.

If one of the following conditions is fulfilled, there will be no automatic switch-off:

- The rotary switch or a key is operated.
- The displayed value is >8.5 % of the final measuring range value.
- "OL" is not displayed during resistance measurement, continuity or diode test.
- No zero value is displayed during frequency measurement.
- An alternating field is detected during the "voltage indicator" measuring function.

4.2.1 "SELECT" key

Selecting a function

Press the "SELECT" key to select the second or third function of the respective rotary switch position.

The last selected function will be stored for each rotary switch position and automatically preselected when setting the function again and after switching the device on again.





Rotary switch position (symbol / designation)	Functions
 V	V-AC → V-DC
 Ω	Ω → continuity
 mV	mV-AC → mV-DC → °C (MM 2-3) → °F (MM 2-3)
	Diode → capacitance (MM 2-2 / MM 2-3)
 A	A (MM 2-2 / MM 2-3) A-AC → A-DC

Table 4: Selecting a function

Display illumination

Press the “SELECT” key (>1 second) to switch on the background lighting of the digital display. After approx. 10 minutes, the background lighting is automatically switched off again. Alternatively, press the “SELECT” key (>1 second) to switch off the background lighting manually.

4.2.2 “RANGE” key

“Measuring range” function

Press the “RANGE” key to disable the automatic measuring range selection (AUTO) and set the measuring range manually. Press the “RANGE” key (>1 second) to enable the automatic measuring range selection afterwards (the “AUTO” symbol will be displayed).

The manual measuring range selection is not available for the following functions:

- Capacitance measurement
- Frequency measurement

“Trigger threshold” function

Press the “RANGE” (“LEVEL”) key to set the trigger threshold of a different voltage range for the frequency measurement in the V-AC or V-DC measuring function.

4.2.3 “MIN MAX” key

“MIN MAX” function

The “MIN MAX” function automatically records the lowest and highest measured value as well as the average value of a measurement series.

Press the “MIN MAX” key to enable the “MIN MAX” function. With the function being enabled, the “MMA” symbol is shown on the digital display. Press the “MIN MAX” key (>1 second) to disable the “MIN MAX” function afterwards.

The device confirms each detection of a new maximum or minimum value with a brief acoustic signal. Press the “MIN MAX” key to toggle between the display of the maximum (MAX), minimum (MIN), average (AVG) and currently measured value (MAX AVG MIN).

If the “MIN MAX” function is enabled, the automatic switch-off (APO, Auto-Power-Off) is disabled.

4.2.4 “HOLD” key

The “HOLD” key has two functions.

“HOLD” function

The “HOLD” function is intended for holding the currently measured value.

Press the “HOLD” key to hold the currently measured value and the “HOLD” symbol is shown on the digital display. Press the “HOLD” key again to discard the held measured value and the currently measured value will be displayed again.

“Relative value” function

The “Relative value” function is intended for storing the currently displayed measured value when the function is enabled. Afterwards, until the function is disabled, the difference (offset) between the stored measured value and the following measured values is shown on the digital display.

Press the “HOLD” key (>1 second) to enable or disable the “Relative value” function. With the function being enabled, the “Δ” symbol is shown on the digital display.

4.2.5 “VoltSense” key

“Voltage indicator” function

The “Voltage indicator” function is intended for non-contact localisation of AC voltages to earth.

Press the “VoltSense” key to enable the “Voltage indicator” function and set the sensitivity of the function using the “RANGE” key. Press the “VoltSense” key again to disable the function afterwards.

4.2.6 “Hz” key

“Hz” function

The “Hz” function is intended for measuring the mains frequency.

Press the “Hz” key to enable the “Hz” function. With the function being enabled, the “Hz” symbol is shown on the digital display. Press the “Hz” key again to disable the function afterwards.

The device determines the frequency of a voltage or a current signal by counting how many times per second the signal exceeds a certain threshold (level). When the “Hz” function is enabled, the input sensitivity adjusts automatically depending on the measuring function used. The 6 V range has the highest sensitivity and the 1 000 V range the lowest.

In the V-AC and V-DC measuring functions, after pressing the “Hz” key, the voltage range with the associated trigger threshold is shown shortly before the frequency measurement. Press the “RANGE” key to set the trigger threshold of another voltage range.

It is recommended to measure the measuring signal (voltage or current) in the automatic measuring range selection (AUTO) first so that the trigger threshold is set automatically, and only then to enable the “Hz” function. If the measured value is not stable, use a lower sensitivity to suppress interference. If the measured value is 0 Hz, use a higher sensitivity.

4.2.7 Jack control (MM 2-2 / MM 2-3)

The device is provided with a visual and acoustic jack control. If a rotary switch position is set that is not admissible for the “A” jack (e. g. voltage measurement) and a safety measuring line is plugged into this socket, an acoustic signal will be emitted and the “InEr” (‘Input error’) will be shown on the digital display to protect the device.

A non-functioning visual and acoustic jack control indicates a defective fuse.

4.3 Measuring ranges

The device is provided with an automatic and a manual switch-over of the measuring range. If a measured value is outside the measuring range, this is indicated by “OL” or “-OL”. Please note that there will be no indication and warning in case of overload.

Measuring accuracy

The measuring accuracy is specified as the sum of the following:

- Relative part of the measured value
- Number of digits (counting steps of the last digit)

The specified measuring accuracy applies at a temperature of 23 °C ±5 °C and a relative air humidity lower than 75 %. In case of deviating temperatures, observe the temperature coefficient by adding the following value to the specified measuring accuracy:

0.15 [1/°C] x specified measuring accuracy x difference to reference temperature range [°C]
(at -10 ... 18 °C or 28 ... 45 °C or specified otherwise)

Additional specifications for AC functions

The measured value is obtained and displayed as a true r.m.s. value (TRUE RMS). For non-sinusoidal curves, the accuracy of the displayed value decreases.

Maximum crest factor of the measuring signal:

- For 50 % of the final measuring range value: 4,1
- For 100 % of the final measuring range value: 2,1
- Square-wave signals are not specified.

4.3.1 Voltage ranges

AC voltage ranges (V-AC)

Overload protection: 600 V-AC / V-DC in the 60 and 600 mV range, 1 100 V-AC / 660 V-DC in the 6, 60 and 600 V range

Measuring range	Resolution	Measuring accuracy
60 mV ^{1), 2)}	0.01 mV	10 ... 500 Hz: ±(1.0 % + 3 digits)
600 mV ³⁾	0.1 mV	500 ... 800 Hz: ±(2.0 % + 3 digits)
6 V ¹⁾	0.001 V	45 ... 50 Hz: ±(2.0 % + 3 digits)
60 V	0.01 V	50 ... 60 Hz: ±(0.7 % + 3 digits)
600 V	0.1 V	60 ... 440 Hz: ±(2.0 % + 3 digits)

Table 5: AC voltage ranges (V-AC)

- 1) Possible display value with short-circuited measuring input and switched-on display illumination: <5 digits, without any influence on the measuring accuracy
- 2) Peak values including DC bias voltage <130 mV peak
- 3) Peak values including DC bias voltage <1 300 mV peak
 - Input resistance: 10 MΩ II, 54 pF

DC voltage ranges (V-DC)

Overload protection: 600 V-AC / V-DC in the 60 and 600 mV range, 1 100 V-AC / 660 V-DC in the 6, 60 and 600 V range

Measuring range	Resolution	Measuring accuracy
60 mV	0.01 mV	±(0.3 % + 2 digits)
600 mV	0.1 mV	
6 V	0.001 V	
60 V	0.01 V	±(0.4 % + 2 digits)
600 V	0.1 V	±(0.2 % + 2 digits)

Table 6: DC voltage ranges (V-DC)

- Input resistance: 10 MΩ II, 54 pF

4.3.2 Current ranges (MM 2-2 / MM 2-3)

AC ranges (A-AC)

Overload protection: 11 A-AC / A-DC

Measuring range	Resolution	Measuring accuracy	Voltage drop
		50 ... 400 Hz	
6 A ¹⁾	0.001 A	±(1.0 % + 3 digits)	40 mV/A
10 A ²⁾	0.01 A		

Table 7: AC ranges (A-AC)

- 1) Possible display value with short-circuited measuring input and switched-on display illumination: <5 digits, without any influence on the measuring accuracy
- 2) A 10 A continuous measurement is admissible.
 - 10 ... 20 A: The maximum measuring time is 30 seconds (pause >5 minutes).

DC ranges (A-DC)

Overload protection: 11 A-AC / A-DC

Measuring range	Resolution	Measuring accuracy	Voltage drop
6 A	0.001 A	±(0.7 % + 3 digits)	40 mV/A
10 A ¹⁾	0.01 A		

Table 8: DC ranges (A-DC)

- 1) A 10 A continuous measurement is admissible.
 - 10 ... 20 A: The maximum measuring time is 30 seconds (pause >5 minutes).

4.3.3 Resistance ranges

Overload protection: 600 V-AC / V-DC

Measuring range ¹⁾	Resolution	Measuring accuracy
600 Ω	0.1 Ω	±(0.3 % + 3 digits)
6 kΩ	0.001 kΩ	
60 kΩ	0.01 kΩ	±(0.5 % + 3 digits)
600 kΩ	0.1 kΩ	
6 MΩ ²⁾	0.001 MΩ	±(0.9 % + 2 digits)
60 MΩ ³⁾	0.01 MΩ	±(0.9 % + 2 digits) ±(5.0 % + 20 digits) at >30 MΩ

Table 9: Resistance ranges (Ω)

- 1) Open-circuit voltage: approx. 1.6 V-DC
- 2) Constant testing current: approx. 0.2 μA
- 3) Constant testing current: approx. 0.02 μA

4.3.4 Continuity test

Overload protection: 600 V-AC / V-DC

Measuring range	Resolution	Measuring accuracy
600 Ω	0.1 Ω	±(0.3 % + 3 digits)

Table 10: Continuity test

- The integrated buzzer sounds and the display illumination flashes at a resistance lower than 30 ... 480 Ω.
- Response time: <15 ms

4.3.5 Diode test

Overload protection: 600 V-AC / V-DC

Measuring range	Resolution	Measuring accuracy
3.0 V	0.001 V	±(0.9 % + 2 digits)

Table 11: Diode test

- Open-circuit voltage: <3.2 V-DC; testing current: approx. 0.3 mA

4.3.6 Capacitance ranges (MM 2-2 / MM 2-3)

Requirements: Discharge the capacitors and apply the safety measuring lines according to the marked polarity.

Overload protection: 600 V-AC / V-DC

Measuring range	Resolution	Measuring accuracy ¹⁾
20 nF	0.01 nF	±(1.5 % + 8 digits)
200 nF	0.1 nF	
2 000 nF	1 nF	±(1.5 % + 2 digits)
20 µF	0.01 µF	
200 µF	0.1 µF	
2 000 µF	1 µF	
10 mF	0.01 mF	±(4.5 % + 10 digits)

Table 12: Capacitance ranges (F)

¹⁾ Valid for film capacitors or better

4.3.7 Frequency ranges

Mains frequency ranges

Overload protection: 600 V-AC / V-DC in the mV range, 1 100 V-AC / 660 V-DC in the 6, 60 and 600 V range, 11 A-AC / A-DC

Measuring function range	Sensitivity (sinusoidal RMS)	Measuring range
mV	50 mV	10 Hz ... 50 kHz
6 V	5 V	
60 V	10 V	
600 V	50 V	10 Hz ... 1 kHz
A	8 A	50 Hz ... 1 kHz

Table 13: Mains frequency ranges (Hz)

- Measuring accuracy: ±(0.03 % + 2 digits)

4.3.8 Temperature ranges (MM 2-3)

Overload protection: 600 V-AC / V-DC

Measuring range	Resolution	Measuring accuracy ^{1), 2)}
-40 ... 99.9 °C	0.1 °C	±(1.0 % + 1 °C)
100 ... 400 °C	1 °C	
-40 ... 99.9 °F	0.1 °F	±(1.0 % + 2.0 °F)
100 ... 752 °F	1 °F	

Table 14: Temperature ranges (°C / °F)

- 1) Add the measuring accuracy of the wire temperature sensor (type K) to the specified measuring accuracy.
 - Measuring range: -20 ... 200 °C (-4 ... 392 °F)
 - Measuring accuracy: ±1.5 °C (±1.8 °F)
- 2) The measuring accuracy applies to stable ambient temperatures lower than ±1 °C. After a change of the ambient temperature of ±5 °C, the measuring accuracy specifications will apply after 1 hour.

5 Operation

The device enables you to carry out various tests and measurements.

5.1 Requirements for tests and measurements

Please observe the following basic requirements for tests and measurements:

- Remove the device (safety measuring lines) from the measuring point before setting a switch position on the rotary switch of the device.
- Only use approved safety measuring lines [[▶ page 28](#)].
- Please consider sources of interference that might be present. Strong sources of interference in the vicinity of the device might involve unstable readings and measuring errors.
- For carrying out the tests and measurements, please observe the associated measuring ranges and measuring accuracies stated in the chapter “Measuring ranges” [[▶ page 22](#)].
- Please note that the last selected function will be stored for each rotary switch position. When setting the rotary switch again (e. g. after switching the device on), the last selected function will be preselected automatically.



DANGER

Maximum admissible voltage

Danger to life or serious injury is possible due to contact with high electric voltage.

- Use the device only in electric circuits up to overvoltage category CAT III with a conductor for a maximum of 600 V or up to overvoltage category CAT IV with a conductor for a maximum of 300 V to earth.

5.2 Connecting the safety measuring lines

For certain tests and measurements, it is necessary to connect the safety measuring lines to the device.

Requirements

- Please observe the requirements for measuring [▶ page 27].
- Safety measuring lines

The safety measuring lines must be approved for the device (e. g. safety measuring lines included in the scope of delivery) and be in a technically perfect and operationally safe condition.

 - Check the specifications regarding nominal voltage and nominal current.
 - Check the insulation of the safety measuring lines.
 - Check the safety measuring lines for continuity.
 - Replace defective safety measuring lines.
- Protective caps (depending on the overvoltage category)
- During tests and measurements, only touch the safety measuring lines in the area intended for your hands.



⚠ WARNING

Dangerous voltage

Danger to life or serious injury is possible due to contact with high electric voltage in case of incorrect operation.

- Do not touch the bare measuring probe tips of the safety measuring lines or the bare contacts of the optional alligator clips. Only touch the safety measuring lines in the area intended for your hands.
- Connect the safety measuring lines to the correspondingly marked measuring jacks of the device and check them for tight fit.
- Only use approved safety measuring lines.
- Attach the protective caps to the contact tips of the safety measuring lines (circuits of overvoltage category CAT III or IV).
- When disconnecting the measuring circuit, first remove the live safety measuring line (phase) and then the neutral safety measuring line from the measuring point.

Procedure

1. Connect the black safety measuring line to the COM jack of the device.
2. Connect the red safety measuring line to the following jack of the device depending on the planned test or measurement:
 - Jack for voltage, frequency, resistance or capacitance measurement, continuity or diode testing
 - A: current measurement (MM 2-2 / MM 2-3)Please observe the information for visual and acoustic jack control [▶ page 21].
3. Measurements or tests with test probes in electric circuits of overvoltage category CAT III or CAT IV: Attach the protective caps to the contact tips of the safety measuring lines.

5.3 Voltage or frequency measurement

Requirements

- Please observe the requirements for measuring [▶ page 27].
- Approved safety measuring lines
- Voltage ranges [▶ page 22] and frequency ranges [▶ page 25]



Figure 9: Voltage or frequency measurement

Procedure

1. Set the rotary switch of the device to switch position “V” or “mV”.
2. Connect the safety measuring lines to the device [▶ page 28].
3. Press the “SELECT” key to set the desired coupling mode of the voltage measurement (AC or DC). As an alternative to voltage measurement, you can switch to frequency measurement by pressing the “Hz” key.
4. Bring the safety measuring lines into contact with the measuring points and read the measured value on the digital display.

5.4 Current or frequency measurement

Requirements

- BENNING MM 2-2 / MM 2-3
- Please observe the requirements for measuring [▶ page 27].
- Approved safety measuring lines
- Current ranges [▶ page 23] and frequency ranges [▶ page 25]



Figure 10: Current or frequency measurement

Procedure

1. Set the rotary switch of the device to switch position “A”.
2. Connect the safety measuring lines to the device [▶ page 28].
3. Press the “SELECT” key to set the desired coupling mode of the current measurement (AC or DC). As an alternative to current measurement, you can switch to frequency measurement by pressing the “Hz” key.
4. Bring the safety measuring lines into contact with the measuring points and read the measured value on the digital display.

5.5 Resistance measurement or continuity testing

Requirements

- Please observe the requirements for measuring [▶ page 27].
- Approved safety measuring lines
- Resistance ranges [▶ page 24] and continuity test [▶ page 24]



Figure 11: Resistance measurement or continuity test

Procedure

1. Set the rotary switch of the device to switch position “Ω”.
2. Connect the safety measuring lines to the device [▶ page 28].
3. Press the “SELECT” key to set the function “Resistance measurement” (“Ω” symbol is displayed) or “Continuity test” (“” symbol is displayed).
4. Bring the safety measuring lines into contact with the measuring points.
 - Resistance measurement: Read the measured value.
 - Continuity test: When the buzzer sounds (acoustic signal) and the digital display lights, the line resistance between the COM jack and the jack for continuity testing falls below the value of 30 to 480 Ω.

5.6 Capacitance measurement or diode testing

Requirements

- Capacitance measurement: BENNING MM 2-2 / MM 2-3
- Please observe the requirements for measuring [▶ page 27].
- Approved safety measuring lines
- Capacitance ranges [▶ page 25] and diode test [▶ page 24]



NOTICE

Capacitors not discharged

Measuring the capacitance at capacitors that are not fully discharged can damage the device.

- Discharge the capacitors completely before measuring the capacitance.
- Do not apply any voltage to the jacks of the device during the capacitance measurement.



Figure 12: Capacitance measurement or diode testing

Procedure

1. Set the rotary switch of the device to switch position "Diode test".
2. Connect the safety measuring lines to the device [► page 28].
3. Press the "SELECT" key to set the function "Capacitance measurement" ("F" symbol) or "Diode test" ("V" symbol and briefly "diod" symbol).
4. Bring the safety measuring lines into contact with the discharged capacitor or the diode – observing correct polarity – and read the measured value on the digital display.

Notes on diode testing:

- Standard Si diode applied in forward direction: A forward voltage from 0.4 to 0.9 V is displayed.
 - "000": indicates a short circuit inside the diode.
 - "OL": indicates an interruption inside the diode.
- Diode applied in reverse direction: "OL" is displayed. In case of defective diodes, "000" or other values will be displayed.

5.7 Temperature measurement

Requirements

- BENNING MM 2-3
- Please observe the requirements for measuring [▶ page 27].
- Temperature sensor

The temperature sensor must be approved for the device (e. g. wire temperature sensor of type K included in the scope of delivery) and be in a technically perfect and operationally safe condition.

- Temperature ranges [▶ page 26]



Figure 13: Temperature measurement

Procedure

1. Set the rotary switch of the device to switch position “mV”.
2. Press the “SELECT” key to set the function “Temperature measurement” (°C or °F). The selected temperature unit is shown on the digital display.
3. Connect the temperature sensor to the device observing correct polarity and make sure that it is firmly connected.
 - Negative pole into the COM jack
 - Positive pole into the jack for temperature measurement
4. Position the contact point (end of the wire temperature sensor) at the measuring point.
5. Wait until the measured value on the digital display has stabilised and read it.

5.8 Voltage indicator



⚠ WARNING

Incorrect use of the function

Danger to life or serious injury is possible due to contact with high electric voltage if the “Voltage indicator” function is used incorrectly.

- Please observe that a dangerous contact voltage might be applied even if it is not indicated by a visual or acoustic signal.
- Do not use the “Voltage indicator” function to test for the absence of voltage.

5.8.1 Non-contact phase testing

There is a detector located on the top left of the device. This detector enables non-contact detection of alternating fields.

Requirements

- Please observe the requirements for measuring [▶ page 27].
- Make sure that no voltage is applied to the jacks of the device. Remove any connected safety measuring lines.



Figure 14: Non-contact phase testing

Procedure

1. Set the rotary switch of the device to switch position "V".
2. Press the "VoltSense" key to enable the "Voltage indicator" function.
"EF-H" appears on the digital display (electric field with high sensitivity).
If necessary, you can reduce the sensitivity by pressing the "RANGE" key. "EF-L" appears on the digital display (electric field with low sensitivity).
3. Place the top left of the device near the measuring point.
If the device detects the phase of an earthed AC voltage, the symbol "EF-H" or "EF-L" will disappear. A bargraph indication and an acoustic signal indicate the strength of the electric field.

Practical tip

Interruptions (cable breaks) in exposed cables – e. g. in cable reels, chains of light, etc. – can be traced from the feeding point (phase) to the point of interruption.

Functional range: ≥ 230 V

5.8.2 External conductor or phase testing

Requirements

- Please observe the requirements for measuring [▶ page 27].
- Approved black safety measuring line
- Make sure that no voltage is applied to the other jacks of the device. Remove a connected red safety measuring line.



Figure 15: External conductor or phase testing

Procedure

1. Set the rotary switch of the device to switch position “V”.
2. Connect the black safety measuring line to the COM jack of the device [▶ page 28].
3. Press the “VoltSense” key to enable the “Voltage indicator” function.
“EF-H” appears on the digital display (electric field with high sensitivity).
If necessary, you can reduce the sensitivity by pressing the “RANGE” key. “EF-L” appears on the digital display (electric field with low sensitivity).
4. Bring the safety measuring line into contact with the measuring point (system part).
If the device detects the phase of an earthed AC voltage, the symbol “EF-H” or “EF-L” will disappear. A bargraph indication and an acoustic signal indicate the strength of the electric field.

6 Maintenance

The battery compartment and the housing may be opened for maintenance work. Apart from that, there are no components in the device that you can replace.



⚠ WARNING

Opening the device

Danger to life or serious injury is possible due to contact with high electric voltage when opening the device. The device might get damaged.

- Make sure that the device is free of voltage before opening the battery compartment or housing.
- Do not open the device (except for the battery compartment and replacing a fuse).
- Please contact your specialty retailer or the returns management for any repairs [▶ page 9].

6.1 Maintenance schedule

The following table provides an overview of all maintenance and servicing work that you must carry out permanently or at regular intervals.

Interval	Measures
Regularly, as needed	• Cleaning the device [▶ page 39]
As needed	• Replacing the batteries [▶ page 40]
Every 12 months	• Calibrating the device [▶ page 41]

Table 15: Maintenance schedule

6.2 Making the device free of voltage

If you want to open the battery compartment or the housing for maintenance work, make sure first that the device is free of voltage.

Procedure

1. Remove the device from the measuring point.
2. Disconnect the safety measuring lines from the device.
3. Set the rotary switch of the device to switch position “OFF”.

6.3 Cleaning the device

Clean the device regularly and as the need arises. Make sure that the battery compartment and the battery contacts are not contaminated by leaking battery electrolyte.

Requirements

- A clean and dry cloth or special cleaning cloth
- Voltage-free device [[▶ page 38](#)]



NOTICE

Wrong cleaning agents

Using the wrong cleaning agents can damage the device.

- Do not use any solvents, abrasives or polishing agents.

Procedure

1. Clean the exterior of the device with a clean and dry cloth or a special cleaning cloth.
2. Check the battery compartment. To open and close the battery compartment, follow the procedure given in the chapter “Replacing the batteries” [[▶ page 40](#)].
3. In case of electrolyte contamination or white deposits in the area of the battery or the battery compartment, clean the batteries and these areas by means of a clean and dry cloth. Replace the batteries, if necessary [[▶ page 40](#)].

6.4 Replacing the batteries

The device is powered by batteries. Replace the batteries as soon as they are discharged.

Requirements

- Discharged batteries inside the device (the battery symbol on the digital display is shown permanently)
- 2 new 1.5 V micro batteries (AAA)
- Voltage-free device [▶ page 38]
- Suitable Phillips screwdriver

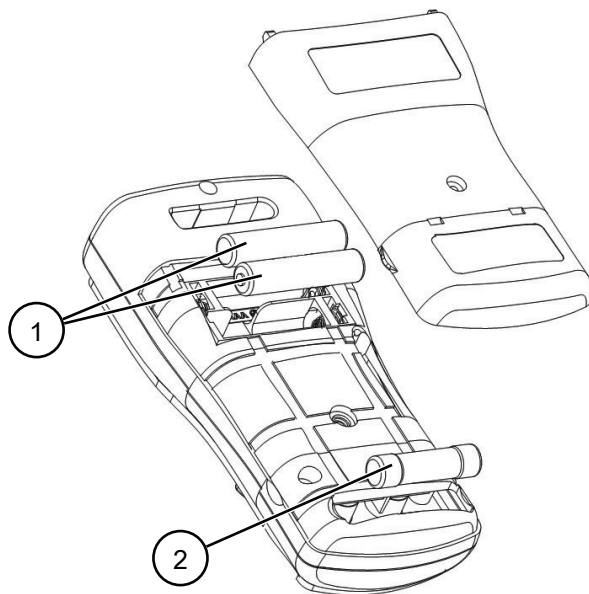

Figure 16: Battery replacement (exemplary)

1	Batteries
2	Fuse (MM 2-2 / MM 2-3)

Procedure

1. Remove the protective rubber holster. To do this, proceed as follows:
 - Hold the device with both hands and press the rubber lip sideways over the edge of the device with your thumbs at the two front upper corners of the device.
 - Pull the protective rubber holster backwards off the device.
2. Place the device face down (onto an anti-slip surface).
3. Unscrew the screw of the battery compartment cover.
4. Lift the battery compartment cover off the device.
5. Remove the discharged batteries from the battery compartment and dispose of them properly [▶ page 43].
6. Insert the new batteries into the battery compartment observing the correct polarity.
7. Place the battery compartment cover back onto the device and tighten the screw.
8. Put the protective rubber holster back onto the device.

6.5 Calibrating the device

Benning guarantees compliance with this technical and accuracy specifications stated in this operating manual for the first 12 months after the delivery date.

To maintain accuracy of the measuring results, make sure that the device is recalibrated in annual intervals by the BENNING Service [▶ page 9].

<http://calibration.benning.de>



6.6 Replacing the fuse

The device is protected against overload by means of a fuse. Replace the fuse if it is defective.

Requirements

- BENNING MM 2-2 / MM 2-3
- Defective fuse inside the device
A non-functioning visual and acoustic jack control [▶ page 21] indicates a defective fuse.
- New fuse (F 11 A, 1 000 V, 20 kA (or better), d = 10 mm, l = 38 mm, e. g. item no. 10218772)
- Voltage-free device [▶ page 38]
- Slotted screwdriver and suitable Phillips screwdriver
- Open battery compartment cover (for this, see the procedure for replacing the batteries [▶ page 40])
- Please observe the figure for battery replacement [▶ page 40].

Procedure

1. Laterally lift one end of the defective fuse off the fuse holder by means of a slotted screwdriver.
2. Remove the defective fuse from the fuse holder and dispose of it properly [▶ page 43].
3. Insert the new fuse and position it centrally in the fuse holder.
4. Place the battery compartment cover back onto the device and tighten the screw.
5. Put the protective rubber holster back onto the device.

7 Technical data

Protection class	II (double or reinforced insulation)
Contamination level	2
Protection category (DIN VDE 0470-1, IEC / EN 60529)	IP 40 1st digit: 4 = protection against access to dangerous parts and protection against solid impurities (diameter >1.0 mm) 2nd digit: 0 = no protection against water
Overvoltage category	<ul style="list-style-type: none"> • CAT III 600 V to earth • CAT IV 300 V to earth
Housing dimensions (length x width x height)	161 mm x 80 mm x 50 mm
Weight (batteries and protective rubber holster included)	0.334 kg
Battery life (zinc-carbon batteries)	approx. 190 h (without background lighting)
Electromagnetic compatibility (EMC)	According to IEC / DIN EN 61326-1, accuracies specified for fields <3 V/m, temperature measurement is not specified. Resistance measurement: plus ±15 digits
Silicone safety measuring lines (item no.: 10231315)	
Standard	IEC / DIN EN 61010-031 (VDE 0411-031)
Overvoltage category (only applies to the safety measuring lines, additionally observe the limitations of the device)	<ul style="list-style-type: none"> • With attachable protective cap: <ul style="list-style-type: none"> – CAT III 1 000 V to earth – CAT IV 600 V to earth • Without attachable protective cap: <ul style="list-style-type: none"> – CAT II 1 000 V to earth
Protection class	II (double or reinforced insulation)
Contamination level	2
Max. rated current	10 A
Length	1.0 m
Operation	
Max. barometric altitude	2 000 m
Operating temperature	-10 ... 45 °C (do not permanently expose the device to sunlight)
Max. relative air humidity	80 % RH (-10 ... 31 °C), linearly decreasing down to 50 % RH at 45 °C, non-condensing
Operating conditions	To be used inside buildings in dry environments
Storage (remove the batteries from the device)	
Ambient temperature	-20 ... 60 °C (do not permanently expose the device to sunlight)
Max. relative air humidity	80 % RH

Table 16: Technical data

8 Disposal and environmental protection



At the end of product life, dispose of the unserviceable device and the batteries via appropriate collecting facilities provided in your community.

Index

A			
AC ranges(A-AC)	23	HOLD	20
AC voltage ranges (V-AC)	22	Hz	21
Accessories	15	Measuring range	20
Automatic switch-off	19	MIN MAX	20
		Relative value	21
		Selecting	19
		Trigger threshold	20
		Voltage indicator	21
		Further information	7
		Fuse	
		Replacing	41
B		H	
Basic knowledge	7	History	8
Battery		Holder of rights	2
Replacing	40		
BENNING MM 2-1	7		
BENNING MM 2-2	7		
BENNING MM 2-3	7		
C		I	
Calibrating	41	Intended use	12
Capacitance measurement	33		
Capacitance ranges	25		
Cleaning	39		
Continuity test	24		
Continuity testing	31		
Copyright	2		
Current measurement	30		
D		J	
DC ranges (A-DC)	23	Jack control	21
DC voltage ranges (V-DC)	23		
Device			
Calibrating	41		
Cleaning	39		
Securing	13		
Device structure	17		
Digital display	18		
Diode test	24		
Diode testing	33		
Disclaimer	2, 12		
Display illumination	20		
Disposal	43		
Documentation	2		
E		K	
Environmental protection	43	Key	
External conductor testing	37	HOLD	20
		Hz	21
		MIN MAX	20
		RANGE	20
		VoltSense	21
F		M	
Frequency measurement	29, 30	Mains frequency ranges	25
Frequency ranges	25	Maintenance	38
Function		Maintenance schedule	38
		Manufacturer	2
		Measurement	
		Requirements	27
		Measuring accuracy	22
		Measuring ranges	22
		AC ranges (A-AC)	23
		AC voltage ranges (V-AC)	22
		Capacitance ranges	25
		Continuity test	24
		DC ranges (A-DC)	23
		DC voltage ranges (V-DC)	23
		Diode test	24
		Mains frequency ranges	25
		Resistance ranges	24
		Temperature ranges	26
		MM 2-1	7
		MM 2-2	7
		MM 2-3	7

N

Non-discrimination	2
--------------------	---

O

Operation	27
-----------	----

P

Phase testing	35, 37
Purpose of the operating manual	8

R

Rear panel of the device	17
Resistance measurement	31
Resistance ranges	24
Return address	9
Returns management	9
Rotary switch	18

S

Safety measuring lines	
Connecting	28
Scope of delivery	15
Securing	13
Selecting a function	19
Service & Support	
Technical Support	9
Standards applied	10
Symbols	
Device	11
Operating manual	11

T

Target group	7
Technical data	42
Technical Support	9
Temperature measurement	34
Temperature ranges	26
Test	
Requirements	27
Trademarks	8

V

Voltage indicator	35, 37
Practical tip	36
Voltage measurement	29
Voltage-free	38

W

Warning system	10
Warranty	12

BENNING

BENNING Elektrotechnik und Elektronik GmbH & Co. KG

Münsterstraße 135 - 137

D - 46397 Bocholt

Phone: +49 2871 93-0 Fax: +49 2871 93-429

Internet: www.benning.de E-Mail: duspol@benning.de

The text and illustrations correspond to the state of technology at the time of printing. Subject to technical changes. No liability accepted for printing errors.