

DE	Gebrauchsanleitung / Montageanleitung	2
FR	Mode d'emploi / Instructions de montage	2
EN	Instructions for use / Assembly instructions	3
IT	Istruzioni per l'uso / Istruzioni per Installazione	3
ES	Modo de empleo / Instrucciones de montaje	4
NL	Gebruiksaanwijzing / Handleiding	4
DK	Brugsanvisning / Monteringsvejledning	5
PT	Instruções para uso / Manual de Instalação	5
PL	Instrukcja obsługi / Instrukcja montażu	6
CS	Návod k použití / Montážní návod	6
SK	Návod na použitie / Montážny návod	7
ZH	用户手册 / 组装说明	7
RU	Руководство пользователя / Инструкция по монтажу	8
FI	Käyttöohje / Asennusohje	8
SV	Bruksanvisning / Monteringsanvisning	9
LT	Vartotojo instrukcija / Montavimo instrukcijos	9
HR	Upute za uporabu / Uputstva za instalaciju	10
RO	Manual de utilizare / Instrucțiuni de montare	10
EL	Οδηγίες χρήσης / Οδηγία συναρμολόγησης	11
SL	Navodilo za uporabo / Navodila za montažo	11
ET	Kasutusjuhend / Paigaldusjuhend	12
LV	Lietošanas pamācība / Montāžas instrukcija	12
SR	Uputstvo za upotrebu / Uputstvo za montažu	13
NO	Bruksanvisning / Montasjeveiledning	13
BG	Инструкция за употреба / Ръководство за монтаж	14
JP	取扱説明書 / 施工説明書	14
UA	Інструкції з використання / Інструкція по збірці	15
AR	دليل الاستخدام / تعليمات التجميع	15
TR	Kullanım kılavuzu / Montaj kılavuzu	16
HU	Használati útmutató / Szerelési útmutató	17
HE	הוראות שימוש / הוראות הרכבה	17

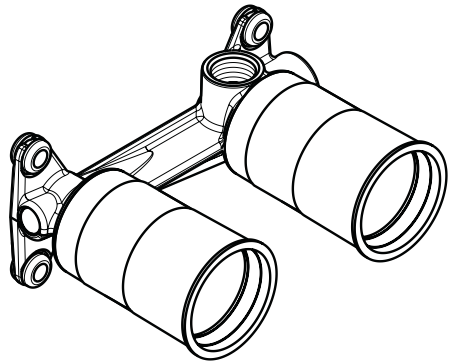

13622180







Sicherheitshinweise

- ⚠ Bei der Montage müssen zur Vermeidung von Quetsch- und Schnittverletzungen Handschuhe getragen werden.
- ⚠ Große Druckunterschiede zwischen den Kalt- und Warmwasseranschlüssen müssen ausgeglichen werden.

Montagehinweise

- Vor der Montage muss das Produkt auf Transportschäden untersucht werden. Nach dem Einbau werden keine Transport- oder Oberflächenschäden anerkannt.
- Die Leitungen und die Armatur müssen nach den gültigen Normen montiert, gespült und geprüft werden.
- Die in den Ländern jeweils gültigen Installationsrichtlinien sind einzuhalten.

Symbolerklärung

-  Kein essigsäurehaltiges Silikon verwenden!
-  **Fertigset** (siehe Seite 20)
-  **Maße** (siehe Seite 18)
-  **Serviceteile** (siehe Seite 18)
-  **Prüfzeichen** (siehe Seite 18)





Consignes de sécurité

- ⚠ Lors du montage, porter des gants de protection pour éviter toute blessure par écrasement ou coupure.
- ⚠ Il est conseillé d'équilibrer les pressions de l'eau chaude et froide.

Instructions pour le montage

- Avant son montage, s'assurer que le produit n'a subi aucun dommage pendant le transport. Après le montage, tout dommage de transport ou de surface ne pourra pas être reconnu.
- Les conduites et la robinetterie doivent être montés, rincés et contrôlés selon les normes en vigueur.
- Les directives d'installation en vigueur dans le pays concerné doivent être respectées.

Description du symbole

-  Ne pas utiliser de silicone contenant de l'acide acétique!
-  **Set de finition** (voir pages 20)
-  **Dimensions** (voir pages 18)
-  **Pièces détachées** (voir pages 18)
-  **Classification acoustique et débit** (voir pages 18)

**Safety Notes**

- ⚠ Gloves should be worn during installation to prevent crushing and cutting injuries.
- ⚠ The hot and cold supplies must be of equal pressures.

Installation Instructions

- Prior to installation, inspect the product for transport damages. After it has been installed, no transport or surface damage will be honoured.
- The pipes and the fixture must be installed, flushed and tested as per the applicable standards.
- The plumbing codes applicable in the respective countries must be observed.

Symbol description

Do not use silicone containing acetic acid!



Finish set (see page 20)



Dimensions (see page 18)



Spare parts (see page 18)



Test certificate (see page 18)

Indicazioni sulla sicurezza

- ⚠ Durante il montaggio, per evitare ferite da schiacciamento e da taglio bisogna indossare guanti protettivi.
- ⚠ Attenzione! Compensare le differenze di pressione tra i collegamenti dell'acqua fredda e dell'acqua calda.

Istruzioni per il montaggio

- Prima del montaggio è necessario controllare che non ci siano stati danni durante il trasporto. Una volta eseguito il montaggio, non verranno riconosciuti eventuali danni di trasporto o delle superfici.
- Montare, lavare e controllare tubature e rubinetteria rispettando le norme correnti.
- Vanno rispettate le direttive di installazione nazionali vigenti nel rispettivo paese.

Descrizione simbolo

Non utilizzare silicone contenente acido acetico!



Set esterno (vedi pagg. 20)



Ingombri (vedi pagg. 18)



Parti di ricambio (vedi pagg. 18)



Segno di verifica (vedi pagg. 18)



Indicaciones de seguridad

- ⚠ Durante el montaje deben utilizarse guantes para evitar heridas por aplastamiento o corte.
- ⚠ Grandes diferencias de presión en servicio entre agua fría y agua caliente deben equilibrarse.

Indicaciones para el montaje

- Antes del montaje se debe examinar el producto contra daños de transporte. Después de la instalación no se reconoce ningún daño de transporte o de superficie.
- Los conductos y la grifería deben montarse, lavarse y comprobarse según las normas vigentes.
- Es obligatorio el cumplimiento de las directrices de instalación vigentes en el país respectivo.

Descripción de símbolos

 No utilizar silicona que contiene ácido acético!

 **Embellecedor exterior**
(ver página 20)

 **Dimensiones** (ver página 18)

 **Repuestos** (ver página 18)

 **Marca de verificación** (ver página 18)

Veiligheidsinstructies

- ⚠ Bij de montage moeten ter voorkoming van knel- en snijwonden handschoenen worden gedragen.
- ⚠ Grote drukverschillen tussen de koud- en warmwater-toevoer dienen vermeden te worden.

Montage-instructies

- Vóór de montage moet het product gecontroleerd worden op transportschade. Na de inbouw wordt geen transport- of oppervlakteschade meer aanvaard.
- De leidingen en armaturen moeten gemonteerd, gespoeld en gecontroleerd worden volgens de geldige normen.
- De in de overeenkomstige landen geldende installatierichtlijnen moeten nageleefd worden.

Symbolbeschrijving

 Gebruik geen zuurhoudende silicone!

 **Kleurset** (zie blz. 20)

 **Maten** (zie blz. 18)

 **Service onderdelen** (zie blz. 18)

 **Keurmerk** (zie blz. 18)



Sikkerhedsanvisninger

- ⚠ Ved monteringen skal der bruges handsker for at undgå kvæstelser og snitsår.
- ⚠ Større trykforskelle mellem koldt og varmt vand bør udjævnes.

Monteringsanvisninger

- Før monteringen skal produktet kontrolleres for transportskader. Efter monteringen godkendes transportskader eller skader på overfladen ikke længere.
- Ledningerne og armaturerne skal monteres, skylles og kontrolleres iht. de gældende standarder.
- Installationsbestemmelserne, der gælder i det enkelte land, skal overholdes.

Symbolbeskrivelse



Der må ikke benyttes eddikesyreholdig silikone!



Kappesæt (se s. 20)



Målene (se s. 18)



Reserve dele (se s. 18)



Godkendelse (se s. 18)

Avisos de segurança

- ⚠ Durante a montagem devem ser utilizadas luvas de protecção, de modo a evitar ferimentos resultantes de entalamentos e de cortes.
- ⚠ Grandes diferenças entre as pressões das águas quente e fria devem ser compensadas.

Avisos de montagem

- Antes da montagem deve-se controlar o produto relativamente a danos de transporte. Após a montagem não são aceites quaisquer danos de transporte ou de superfície.
- As tubagens e a torneira têm que ser montadas, enxaguadas e verificadas de acordo com as normas em vigor.
- A prescrições de instalação válidas nos respetivos países devem ser respeitadas.

Descrição do símbolo



Não utilizar silicone que contenha ácido acético!



Conjunto completo (ver página 20)



Medidas (ver página 18)



Peças de substituição (ver página 18)



Marca de controlo (ver página 18)



**Wskazówki bezpieczeństwa**

- ⚠ Aby uniknąć zranień na skutek zgniecenia lub przecięcia, podczas montażu należy nosić rękawice ochronne.
- ⚠ Znaczne różnice ciśnień na dopływach ciepłej i zimnej wody muszą zostać wyrównane.

Wskazówki montażowe

- Przed montażem należy skontrolować produkt pod kątem szkód transportowych. Po montażu nie widać żadnych szkód transportowych ani szkód na powierzchni.
- Przewody i armatura muszą być montowane, płukane i kontrolowane według obowiązujących norm.
- Należy przestrzegać wytycznych instalacyjnych obowiązujących w danym kraju.

Opis symbolu

Nie stosować silikonów zawierających kwas octowy!

**Elementy zewnętrzne**

(patrz strona 20)

**Wymiary** (patrz strona 18)**Części serwisowe** (patrz strona 18)**Znak jakości** (patrz strona 18)**Bezpečnostní pokyny**

- ⚠ Pro zabránění řezným zraněním a pohmožděním je nutné při montáži nosit rukavice.
- ⚠ Je nutné vyrovnat velké rozdíly tlaku mezi přípoji studené a teplé vody.

Pokyny k montáži

- Před montáží je třeba produkt zkontrolovat, zda nebyl při transportu poškozen. Po zabudování nebudou uznány žádné škody způsobené transportem nebo poškození povrchu.
- Vedení a armatura musí být namontovány, propláchnuty a otestovány podle platných norem.
- Je třeba dodržovat montážní pravidla platné v dané zemi.

Popis symbolů

Nepoužívat silikon s obsahem kyseliny octové!

**Vrchní sada** (viz strana 20)**Rozměry** (viz strana 18)**Servisní díly** (viz strana 18)**Zkušební značka** (viz strana 18)

**Bezpečnostné pokyny**

- △ Pri montáži musíte nosiť rukavice, aby ste predišli pomliaždeninám a rezným poraneniam.
- △ Veľké rozdiely v tlaku medzi prípojkami studenej a teplej vody musia byť vyrovnané.

Pokyny pre montáž

- Pred montážou musíte produkt skontrolovať, či nebol počas transportu poškodený. Po zabudovaní nebudú uznané žiadne škody spôsobené transportom alebo poškodenia povrchu.
- Potrubia a vybavenie musia byť namontované, prepláchnuté a vybavené v platnom normami.
- Je potrebné dodržiavať smernice o inštalácii, ktoré sú práve teraz platné v krajinách.

Popis symbolov

 Nepoužívať silikón s obsahom kyseliny octovej!

 **Vrchná sada** (viď strana 20)

 **Rozmery** (viď strana 18)

 **Servisné diely** (viď strana 18)

 **Osvedčenie o skúške** (viď strana 18)

安全技巧

- △ 装配时为避免挤压和切割受伤, 必须戴上手套.
- △ 冷热水管间过大的压力差必须予以平衡.

安装提示

- 安装前必须检查产品是否受到运输损害. 安装后将不认可运输损害或表面损伤.
- 管道和阀门必须根据通用标准进行安装, 冲洗和检查.
- 请遵守当地国家现行的安装规定.

符号说明

 请勿使用含有乙酸的硅胶!

 **加工件** (参见第页 20)

 **大小** (参见第页 18)

 **备用零件** (参见第页 18)

 **检验标记** (参见第页 18)



Указания по технике безопасности

- ⚠ Во время монтажа следует надеть перчатки во избежание прищемления и порезов.
- ⚠ донного клапа. Перед установкой смесителя необходимо регулировочными кранами выровнять авление холодной и горячей воды при помощи вентмлей регулирующих подачу воды в квартиру.

Указания по монтажу

- Перед монтажом следует проверить изделие на предмет повреждений при перевозке. После монтажа претензии о возмещении ущерба за повреждения при перевозке или повреждения поверхностей не принимаются.
- Трубы и арматура должны быть установлены, промыты и проверены в соответствии с действующими нормами.
- Необходимо соблюдать требования по монтажу, действующие в соответствующих странах.

Описание символов

 Не применяйте силикон, содержащий уксусную кислоту.

 **Наружная часть** (см. стр. 20)

 **Размеры** (см. стр. 18)

 **Комплект** (см. стр. 18)

 **Знак технического контроля** (см. стр. 18)

Turvallisuusohjeet

- ⚠ Asennuksessa on käytettävä käsineitä puristumien ja viiltojen aiheuttamien tapaturmien estämiseksi.
- ⚠ Suuret paine-erot kylmä- ja kuumavesiliitäntöjen välillä on tasattava.

Asennusohjeet

- Ennen asennusta on tarkastettava tuotteen mahdolliset kuljetusvahingot. Asennuksen jälkeen kuljetus- ja pintavaurioita ei hyväksytä.
- Putket ja hana on asennettava, huuhdeltava ja tarkastettava voimassa olevien standardien mukaisesti.
- Jokaisessa maassa on noudatettava siellä päteviä asennusohjeita.

Merkin kuvaus

 Älä käytä etikahappopitoista silikonia!

 **Valmissarja** (katso sivu 20)

 **Mitat** (katso sivu 18)

 **Varaosat** (katso sivu 18)

 **Koestusmerkki** (katso sivu 18)

**Säkerhetsanvisningar**

- △ Handskar ska bäras under monteringsarbetet så att man kan undvika kläm- och skärskador.
- △ Stora tryckskillnader mellan anslutningarna för varmt och kallt vatten måste utjämnas.

Monteringsanvisningar

- Det måste undersökas om produkten har transportskador innan den monteras. Efter monteringen accepteras inga transport- eller ytskiktsskador.
- Ledningarna och blandaren måste monteras, spolas igenom och kontrolleras enligt de gällande normerna.
- De installationsriktlinjer som gäller i länderna ska följas.

Symbolförklaring

Använd inte silikon som innehåller ättiksyra!



Färdigset (se sidan 20)



Måtten (se sidan 18)



Reservdelar (se sidan 18)



Testsigill (se sidan 18)

Saugumo technikos nurodymai

- △ Apsaugai nuo užspaudimo ir įsijiovimo montavimo metu mūvėkite pirštines.
- △ Turi būti išlyginti šalto ir karšto slėgio nelygumai.

Montavimo instrukcija

- Prieš montuojant būtina patikrinti, ar gaminyje nebuvo pažeistas transportavimo metu. Sumontavus pretenzijos dėl transportavimo ir paviršiaus pažeidimų nepriimamos.
- Vamzdžiai ir sujungimai turi būti montuojami, plaunami ir tikrinami pagal galiojančias normas.
- Laikytis atitinkamoje šalyje galiojančių direktyvų dėl įrengimo.

Simbolio aprašymas

Nenaudokite silikono, kurio sudėtyje yra acto rūgšties!



Virštinkinė (žr. psl. 20)



Išmatavimai (žr. psl. 18)



Atsarginės dalys (žr. psl. 18)



Bandymo pažyma (žr. psl. 18)





Sigurnosne upute

- ⚠ Prilikom montaže se radi sprječavanja prignječenja i posjekotina moraju nositi rukavice.
- ⚠ Velika razlika u pritisku između vruće i hladne vode mora biti izbalansirana.

Upute za montažu

- Prije montaže mora se provjeriti je li proizvod oštećen prilikom transporta. Nakon ugradnje se ne priznaju nikakve reklamacije koje se odnose na površinska i transportna oštećenja.
- Cijevi i armatura moraju biti postavljeni, isprani i testirani prema važećim normama.
- Obvezno se moraju uvažiti propisi o instalacijama koji vrijede u dotičnoj zemlji.

Opis simbola

 Nemojte koristiti silikon koji sadrži octenu kiselinu!

 **Završni set** (pogledaj stranicu 20)

 **Mjere** (pogledaj stranicu 18)

 **Rezervni djelovi** (pogledaj stranicu 18)

 **Oznaka testiranja**
(pogledaj stranicu 18)

Instrucțiuni de siguranță

- ⚠ La montare utilizați mănuși pentru evitarea contuziunilor și tăierii mâinilor.
- ⚠ Diferențele de presiune mari între alimentarea cu apă rece și apă caldă trebuie echilibrate.

Instrucțiuni de montare

- Înainte de instalare verificați, dacă produsul prezintă deteriorări de transport. După instalare garanția nu acoperă deteriorările de transport și cele de suprafață.
- Conductele și bateriile trebuie montate, spălate și verificate conform normelor în vigoare.
- Respectați reglementările referitoare la instalare valabile în țara respectivă.

Descrierea simbolurilor

 Nu utilizați silicon cu conținut de acid acetic!

 **Set complet** (vezi pag. 20)

 **Dimensiuni** (vezi pag. 18)

 **Piese de schimb** (vezi pag. 18)

 **Certificat de testare** (vezi pag. 18)

**Υποδειξεις ασφαλείας**

- ⚠ Για να αποφύγετε τραυματισμούς κατά τη συναρμολόγηση πρέπει να φοράτε γάντια.
- ⚠ Οι διαφορές της πίεσης μεταξύ της σύνδεσης κρύου και ζεστού νερού θα πρέπει να αντισταθμίζονται.

Οδηγίες συναρμολόγησης

- Πριν τη συναρμολόγηση πρέπει να εξεταστεί το προϊόν για ζημιές μεταφοράς. Μετά την εγκατάσταση δεν αναγνωρίζονται ζημιές από τη μεταφορά ή επιφανειακές ζημιές.
- Οι σωλήνες και η μπαταρία πρέπει να τοποθετηθούν σύμφωνα με τα ισχύοντα πρότυπα, να τεθούν υπό πίεση και να δοκιμαστούν.
- Θα πρέπει να τηρούνται οι οδηγίες εγκατάστασης που ισχύουν σε κάθε κράτος.

Περιγραφή συμβόλων

Μην χρησιμοποιείτε σιλικόνη που περιέχει οξικό οξύ!



Σετ μηχανισμού (βλ. Σελίδα 20)



Διαστάσεις (βλ. Σελίδα 18)



Ανταλλακτικά (βλ. Σελίδα 18)



Σήμα ελέγχου (βλ. Σελίδα 18)

Varnostna opozorila

- ⚠ Pri montaži je treba nositi rokavice, da se preprečijo poškodbe zaradi zmečkanja ali urezov.
- ⚠ Velike razlike v tlaku med priključkom za mrzlo in priključkom za toplo vodo je potrebno izravnati.

Navodila za montažo

- Pred montažo je treba izdelek preveriti glede morebitnih transportnih poškodb. Po vgradnji transportne ali površinske poškodbe ne bodo več priznane.
- Cevi in armaturo je treba montirati, izprati in preveriti po veljavnih standardih.
- Upoštevati je treba pravilnike o inštalacijah, ki veljajo v posamezni državi.

Opis simbola

Ne smete uporabiti silikona, ki vsebuje očetno kislino!



Zaključna garnitura (glejte stran 20)



Mere (glejte stran 18)



Rezervni deli (glejte stran 18)



Preskusni znak (glejte stran 18)







Ohutusjuhised

- △ Kandke paigaldamisel muljumis- ja löihevigastuste vältimiseks kindaid.
- △ Kui külma ja kuuma vee ühenduste surve on väga erinev, tuleb need tasakaalustada.

Paigaldamisjuhised

- Enne paigaldamist tuleb toodet kontrollida transpordikahjustuste osas. Pärast paigaldamist ei tunnustata enam transpordi- või pinnakahjustuste kaebuseid.
- Voolikute ja segisti paigaldamisel, loputamisel ja kontrollimisel tuleb lähtuda kehtivatest normatiividest.
- Vastavas riigis kehtivaid paigalduseeskirju tuleb järgida.

Sümbolite kirjeldus

-  Ärge kasutage äädikhapet sisaldavat silikooni!
-  **Valmiskomplekt** (vt lk 20)
-  **Mõõtude** (vt lk 18)
-  **Varuosad** (vt lk 18)
-  **Kontrollsertifikaat** (vt lk 18)





Drošības norādes

- △ Montāžas laikā, lai izvairītos no saspiedumiem un iegriezumiem, nepieciešams nēsāt cimdus.
- △ Jāizlīdzina spiediena atšķirības starp aukstā un karstā ūdens pievadiem.

Norādījumi montāžai

- Pirms montāžas nepieciešams pārbaudīt, vai produktam transportēšanas laikā nav radušies bojājumi. Pēc iebūvēšanas bojājumi, kas radušies transportēšanas laikā, vai virsmas bojājumi netiek atzīti.
- Cauruļvadi un maisītājs ir jāuzstāda, jāizskalo un jāpārbauda saskaņā ar spēkā esošajiem standartiem.
- Jāievēro attiecīgās valstīs spēkā esošās montāžas prasības.

Simbolu nozīme

-  Neizmantojiet silikonu, kas satur etiķskābi!
-  **Komplekts** (skat. lpp. 20)
-  **Izmērus** (skat. lpp. 18)
-  **Rezerves daļas** (skat. lpp. 18)
-  **Pārbaudes zīme** (skat. lpp. 18)

**Sigurnosne napomene**

- ⚠ Prilikom montaže se radi sprečavanja prignječenja i posekotine moraju nositi rukavice.
- ⚠ Velika razlika u pritisku između vruće i hladne vode mora biti izbalansirana.

Instrukcije za montažu

- Pre montaže se mora proveriti da li je proizvod oštećen pri transportu. Nakon ugradnje se ne priznaju nikakve reklamacije koje se odnose na površinska i transportna oštećenja.
- Vodovi i armatura moraju biti postavljeni, isprani i testirani prema važećim normama.
- Treba se pridržavati propisa koji u određenim zemljama važe za instalacije.

Opis simbola

 Nemojte koristiti silikon koji sadrži sirćetnu kiselinu!

 **Završni set** (vidi stranu 20)

 **Mere** (vidi stranu 18)

 **Rezervni delovi** (vidi stranu 18)

 **Ispitni znak** (vidi stranu 18)

Sikkerhetshenvisninger

- ⚠ Bruk hansker under montasjen for å unngå klem- og kuttskader.
- ⚠ Store trykkdifferanser mellom kaldt- og varmtvannstilkoblinger skal utlignes.

Montagehenvisninger

- Før montasjen skal produktet sjekkes for transportskader. Etter monteringen aksepteres ikke noen transport- eller overflateskader.
- Ledningene og armaturen skal monteres, spyles og sjekkes iht. de gyldige normer.
- Gjeldende retningslinjer for rørleggerarbeid i de enkelte land skal følges.

Symbolbeskrivelse

 Ikke bruk silikon som inneholder eddiksyre!

 **Ferdigsett** (se side 20)

 **Mål** (se side 18)

 **Serviceleder** (se side 18)

 **Prøveemerke** (se side 18)



Указания за безопасност

- △ При монтажа трябва да се носят ръкавици, за да се избегнат наранявания поради притискане или порязване.
- △ Големите разлики в налягането между изводите за студената и топлата вода трябва да се изравняват.

Указания за монтаж

- Преди монтажа продуктът трябва да се провери за транспортни щети. След монтажа не се признават транспортни или повърхностни щети.
- Тръбопроводите и арматурата трябва да се монтират, промият и проверят в съответствие с валидните норми.
- Трябва да бъдат спазвани валидните в съответните страни предписания за инсталиране.

Описание на символите

 Не използвайте силикон, съдържащ оцетна киселина!

 **Готов набор** (вижте стр. 20)

 **Размери** (вижте стр. 18)

 **Сервизни части** (вижте стр. 18)

 **Контролен знак** (вижте стр. 18)

安全上の注意

- △ 施工の際は手を挟んだり怪我をしないように、手袋をはめてください。
- △ 給水・湯の圧力差は0.1(MPa)以内としてください。

施工上の注意

- 製品の施工前に輸送でのダメージがないか確認してください。施工後のキズ等のお申し出はお断りさせていただきます。
- 配管と水栓は、関連法規に従って施工、洗浄、および試験を行ってください。
- 施工行方地域に適用される関連法規をお守りください。

アイコンの説明

 酢酸系シリコンをご使用にならないでください!

 **化粧部** (次のページを参照 20)

 **寸法** (次のページを参照 18)

 **スペアパーツ** (次のページを参照 18)

 **認証について** (次のページを参照 18)

**Примітки з безпеки**

- ⚠ Під час встановлення слід надягати рукавички, щоб запобігти травмам та порізам.
- ⚠ Гаряча і холодна подачі води повинні мати однаковий тиск.

Інструкції зі встановлення

- Перед встановленням перевірте виріб на наявність пошкоджень під час транспортування. Після встановлення транспортні пошкодження чи пошкодження поверхні не розглядаються.
- Труби та кріплення повинні бути встановлені, промиті та перевірені відповідно до стандартів застосування.
- Необхідно дотримуватися сантехнічних норм, які діють у відповідних країнах.

Опис символу

 Не використовуйте силікон, що містить оцтову кислоту!

 **Фінішний набір** (дивіться сторінку 20)

 **Розміри** (дивіться сторінку 18)

 **Запчастини** (дивіться сторінку 18)

 **Тестовий сертифікат**
(дивіться сторінку 18)

تنبيهات الأمان

- ⚠ يجب إرتداء قفازات لليد أثناء التركيب لتجنب حدوث أخطار الإنحشار أو الجروح.
- ⚠ يجب أن يكون تيار الماء الساخن والماء البارد متعادلين في الضغط.

تعليمات التركيب

- قبل القيام بعملية التركيب، يجب فحص المنتج للتأكد من خلوه من أية تلفيات ناتجة عن النقل. بعد القيام بعملية التركيب، لن يتم الاعتراف بوجود أية تلفيات سطحية أو تلفيات ناتجة عن عملية النقل.
- يجب تركيب وغسيل واختبار التوصيلات وخلاطات المياه طبقاً للمعايير السارية.
- يجب مراعاة القواعد الخاصة بالتركيب وأعمال السباكة وفقاً للوائح الخاصة بكل بلد.

وصف الرمز

 هام! لا تستخدم السليكون الذي يحتوي على أحماض!

 **مجموعة كاملة.** (راجع صفحة 20)

 **أبعاد** (راجع صفحة 18)

 **قطع الغيار** (راجع صفحة 18)

 **شهادة اختبار** (راجع صفحة 18)

Монтажний
(дивіться сторінку 19) 

التركيب
(راجع صفحة 19) 





Güvenlik uyarıları

- ⚠ Montaj esnasında ezilme ve kesilme gibi yaralanmaları önlemek için eldiven kullanılmalıdır.
- ⚠ Sıcak ve soğuk su bağlantıları arasında büyük basınç farklılıkları varsa, bu basınç farklılıklarının dengelenmesi gerekir.

Montaj açıklamaları

- Montaj işleminden önce ürün nakliye hasarları yönünden kontrol edilmelidir. Montaj işleminden sonra nakliye veya yüzey hasarları için sorumluluk üstlenilmemektedir.
- Boruların ve armatürün montajı, yıkanması ve kontrolü geçerli normlara göre yapılmalıdır.
- Ülkelerde geçerli kurulum yönetmeliklerine riayet edilmelidir.

Simge açıklaması

-  Asetik asit içeren silikon kullanmayın!
-  **Dışı set** (bakınız sayfa 20)
-  **Ölçüleri** (bakınız sayfa 18)
-  **Yedek Parçalar** (bakınız sayfa 18)
-  **Kontrol işareti** (bakınız sayfa 18)

Garanti Belgesi

Üretici veya İthalatçı Firmanın

Unvanı: Hansgrohe Armatür Ltd. Şti
Adresi: Fulya Mahallesi Bahçeler Sokak Efe han 20/C
Mecidiyeköy Şişli İstanbul
(0-212) 273 07 30
(0-212) 273 07 40
www.hansgrohe.com.tr

Malın

Markası: Hansgrohe
Cinsi: Sıhhi tesisat malzemesi
Garanti Süresi: 2 YIL
Azami Tamir Süresi: 20 İş günü

Genel Müdür

Albert Emlek
Satıcı Firmanın:

Unvanı:
Adresi:
Telefonu:
Faks:
e-posta:
Fatura Tarih ve Sayısı:
Marka ve Modeli:
Teslim Tarihi ve Yeri:
Yetkilinin İmzası:
Firmanın Kaşesi:
Bu bölümü, ürünü aldığınız Yetkili Satıcı imzalayacak ve kaşeleyecektir.



Montajı

(bakınız sayfa 19)



**Biztonsági utasítások**

- ⚠ A szerelésnél a zúzdások és vágási sérülések elkerülése érdekében kesztyűt kell viselni.
- ⚠ A hidegvíz- és a melegvíz-csatlakozások közötti nagy nyomáskülönbséget kikell egyenlíteni!

Szerelési utasítások

- A szerelés előtt ellenőrizni kell, hogy a terméknek nincs-e szállítási sérülése. Beépítés után a szállítási- vagy felületi sérüléseket nem ismerik el.
- A vezetékeket és a csaptelepet az érvényes szabványoknak megfelelően kell felszerelni, öblíteni és ellenőrizni
- Az egyes országokban érvényes installációs irányelveket be kell tartani.

Szimbólumok leírása

Ne használjon ecetsavtartalmú szilikont!



A kész szerelvény (lásd a oldalon 20)



Méretet (lásd a oldalon 18)



Tartozékok (lásd a oldalon 18)



Vizsgajel (lásd a oldalon 18)

הערות בטיחות

- ⚠ יש להשתמש בכפפות בזמן ההתקנה כדי למנוע פציעות וחתכים
- ⚠ למערכת המים החמים והקרים צריכים להיות לחצים שווים

הוראות התקנה

- לפני ההתקנה, בדוק אם נגרמו למוצר נזקים בהובלה אחרי ההתקנה, לא נכיר בנזקים שנגרמו בהובלה או בנזקים במשטחים
- חובה להתקין את הצינורות והאביזרים, לשטוף אותם ולבדוק אותם על פי התקנים הישימים
- צריך לפעול על פי חוקי השרברבות הישימים במדינת ההתקנה

תיאור הסמל

אסור להשתמש בסיליקון המכיל חומצה אצטית!



סט גימור (ראה עמוד 20)



מידות (ראה עמוד 18)



חלקי חילוף (ראה עמוד 18)



תעודת בדיקה (ראה עמוד 18)



Сzerelés
(lásd a oldalon 19)

הרכבה
(ראה עמוד 19)

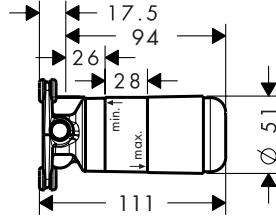
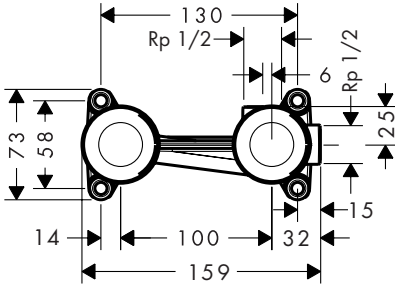

DVGW **STF** CERTIFICATION BODY **SE** KIWA 100

ETA

13622180 CS0564 X 1862  1.42/19221

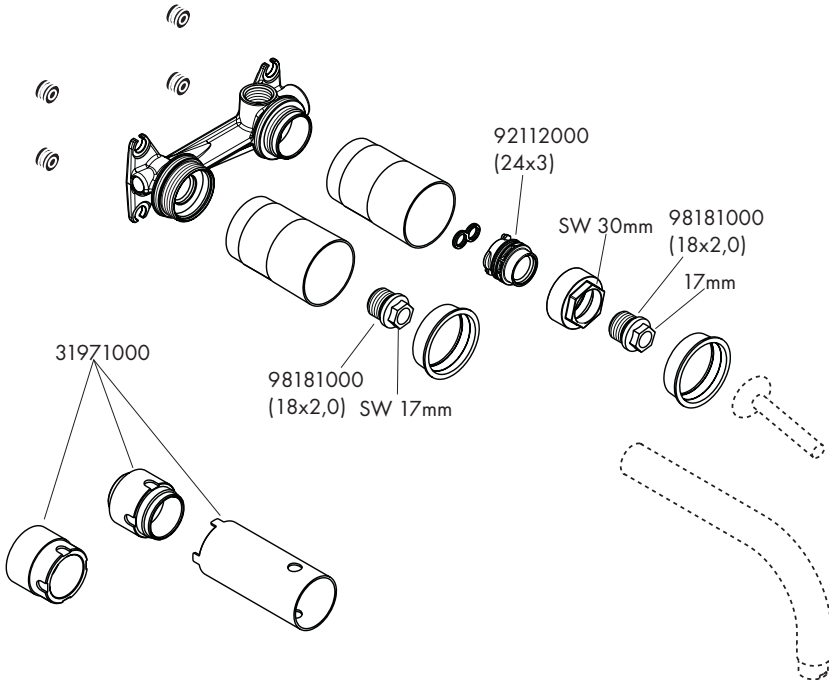

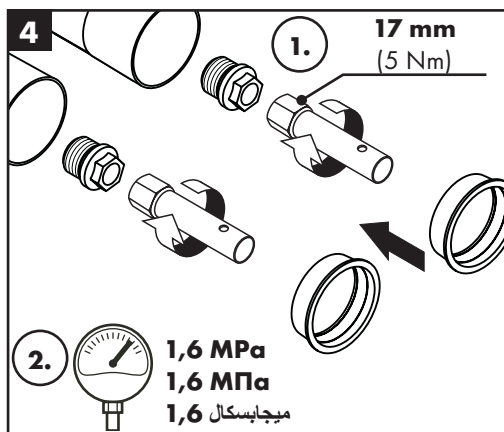
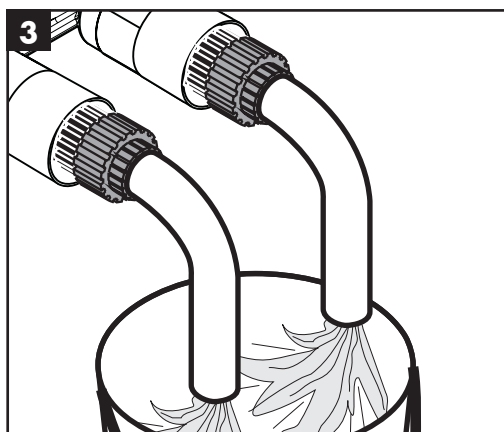
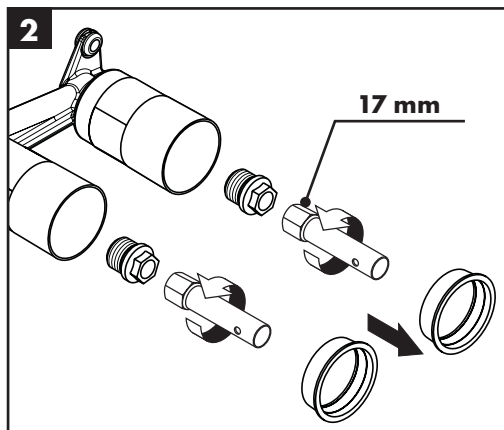
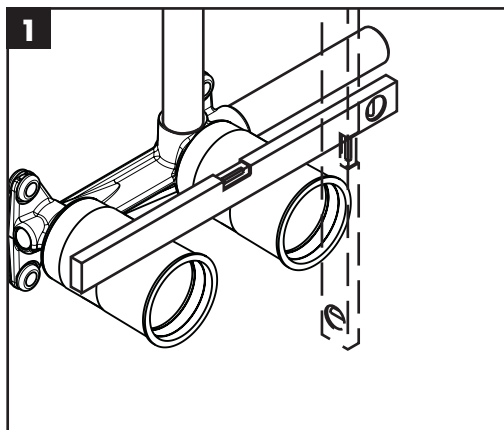
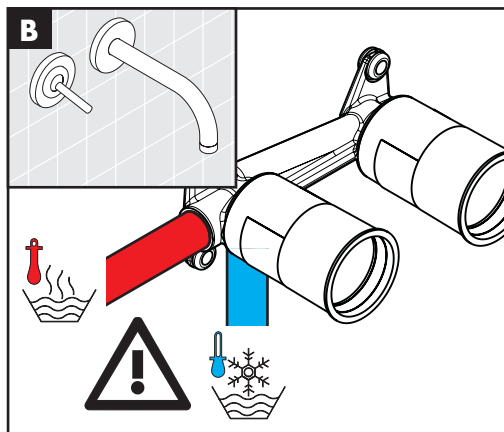
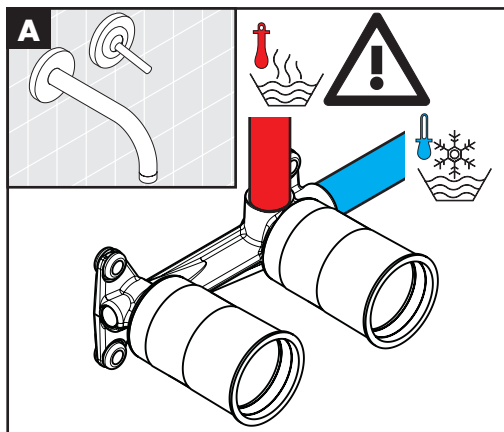



PuraVida

15084XX0 / 15085XX0

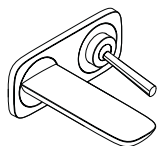

Metris

31085000 / 31251000 /
31086000

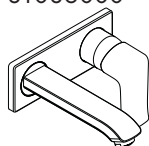

Metris Classic

31000XX0 / 31003XX0

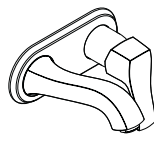

Metris S

31162000 / 31163000

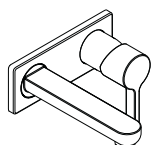

Talis

31618000 / 31620000 /
31611000

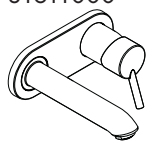

Logis

71220000

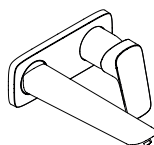

Talis E

71732000 / 71734000

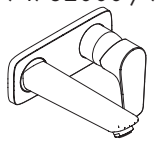

Talis S

72110000 / 72111000

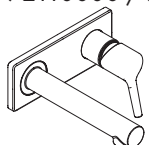

Metropol

32525000 / 32526000

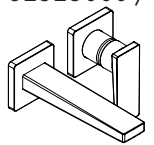

Metropol

74525000 / 74526000

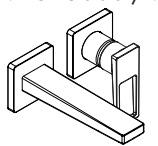

Finoris

76050XX0 / 76051XX0

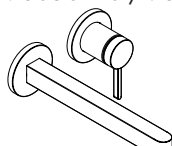

Vernis Blend

71576000

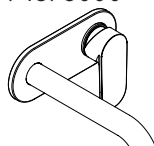

Vernis Shape

71578000

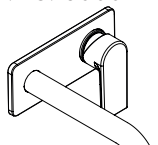

Rebris E

72568XX0

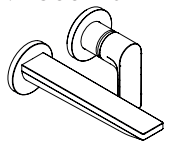

Rebris S

72528XX0

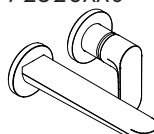

Vivenis

75050XX0

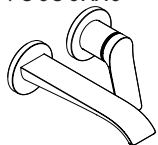

Tecturis E

73051XX0

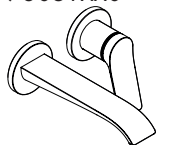

Tecturis S

73350XX0 / 73351XX0

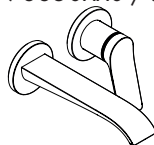



PuraVida
15084XX0

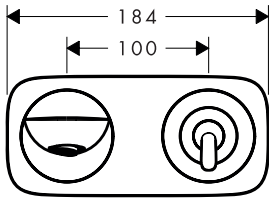
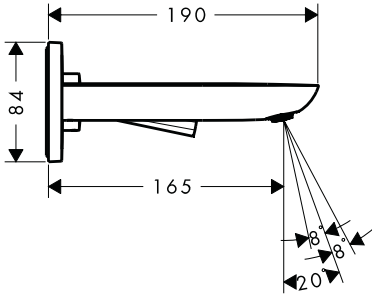

PuraVida
15085XX0

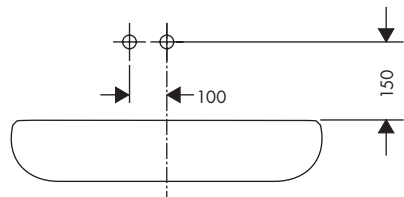
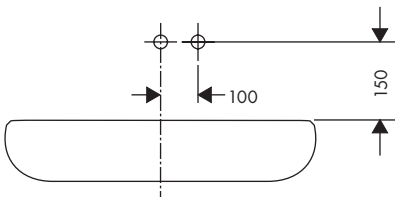
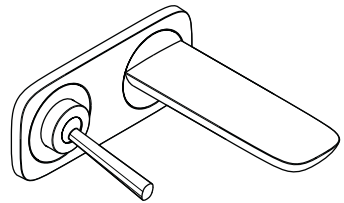
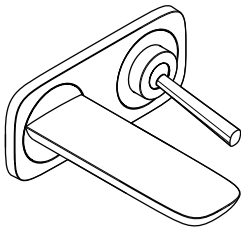
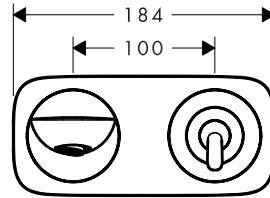
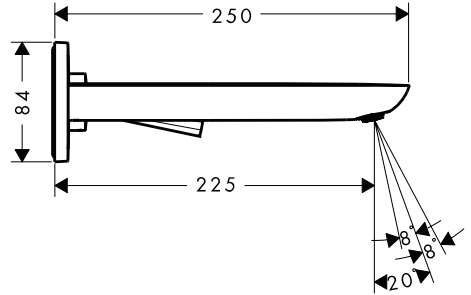



Metris

31085000 / 31251000

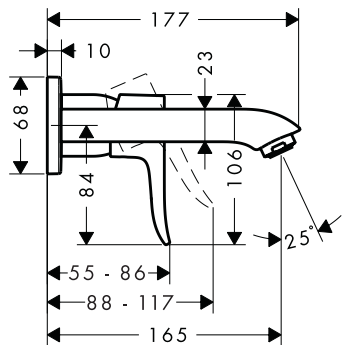

Metris

31086000

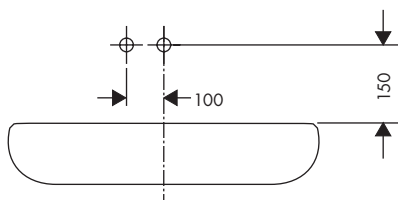
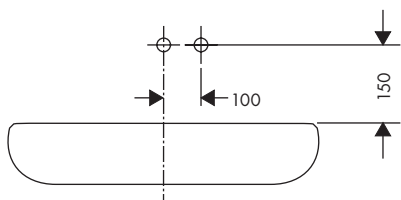
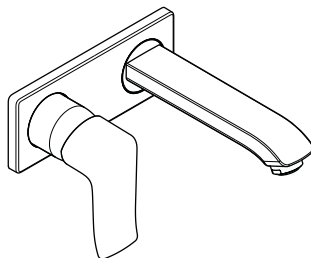
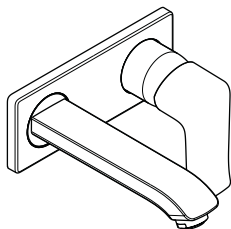
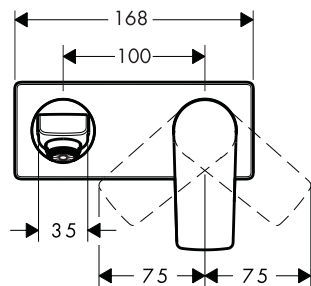
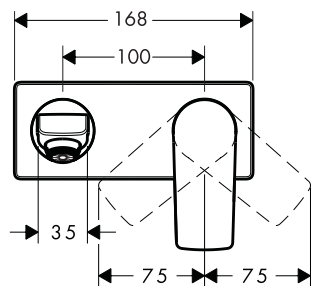
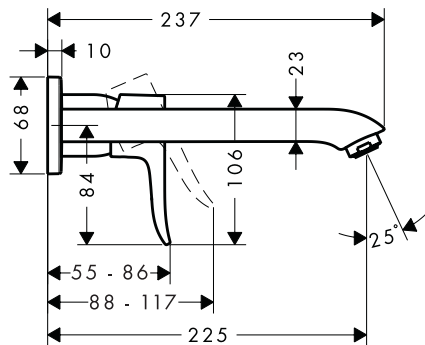



Metris Classic

31000XX0

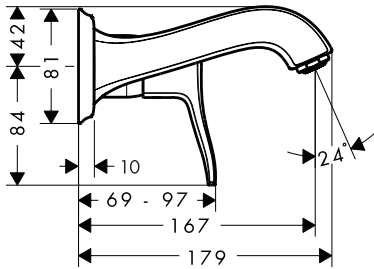

Metris Classic

31003XX0

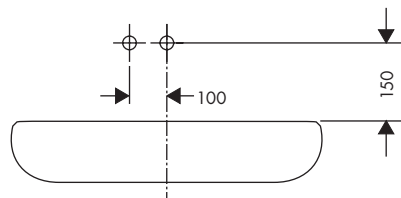
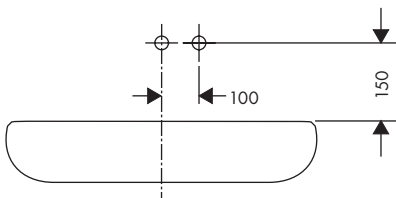
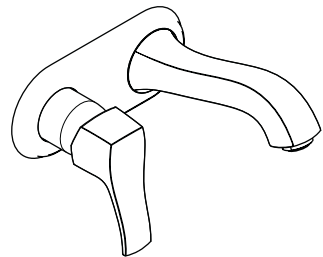
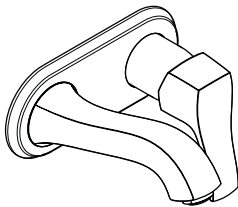
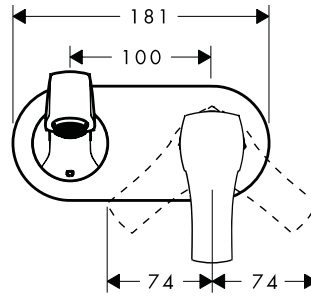
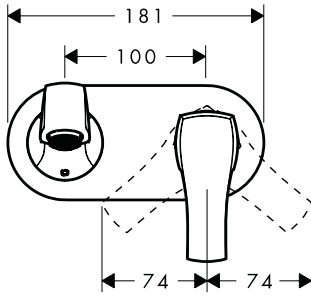
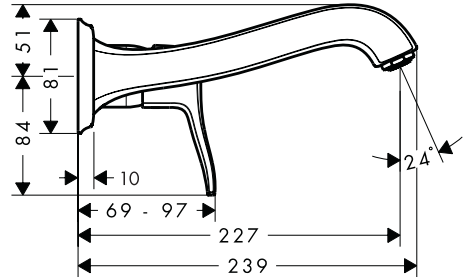



Metris S
31162000

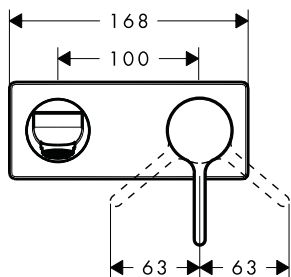
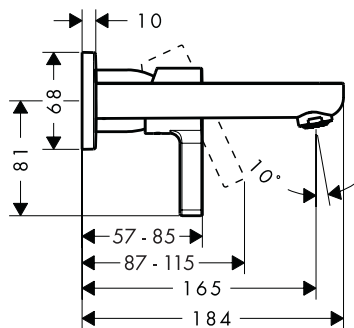

Metris S
31163000

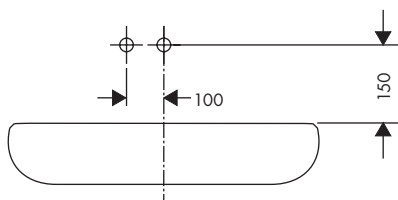
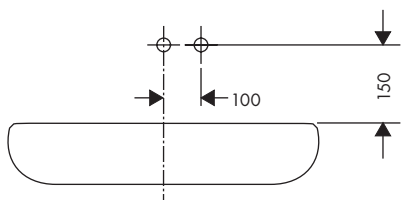
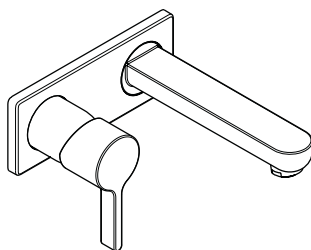
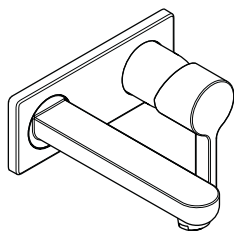
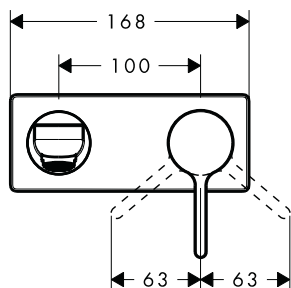
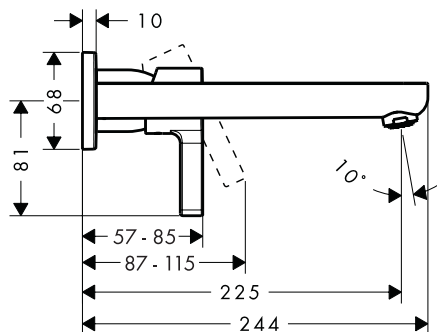



Talis
31618000 / 31620000

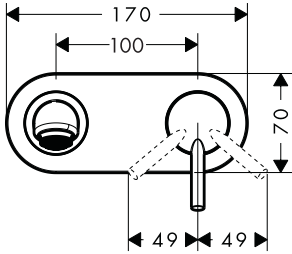
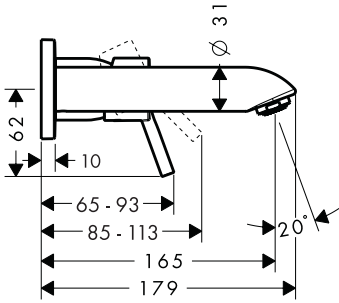

Talis
31611000

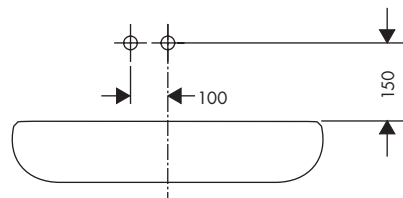
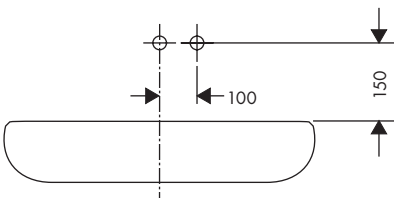
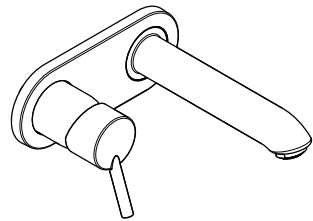
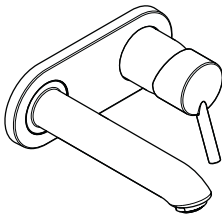
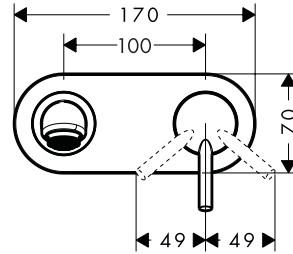
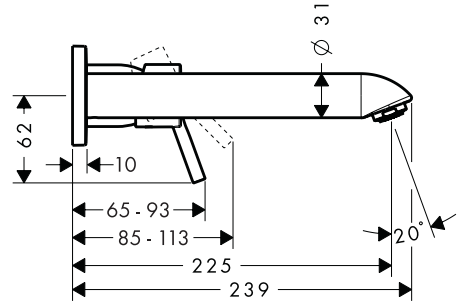



Logis

71220000

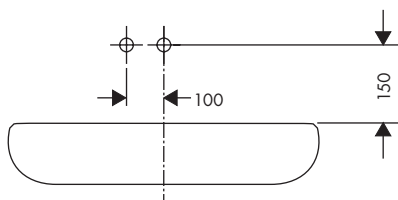
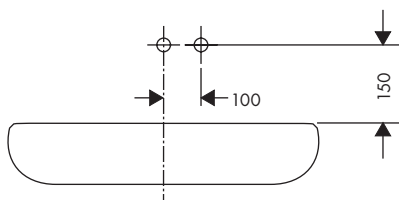
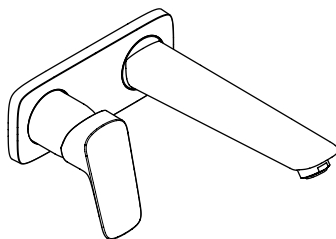
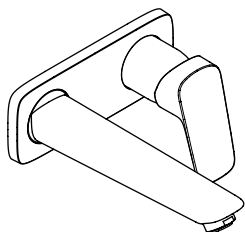
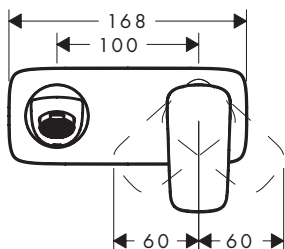
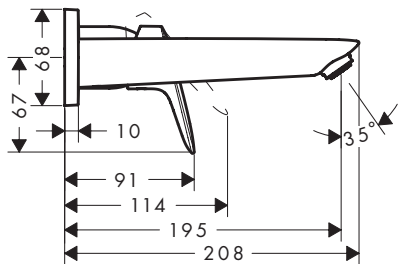



Talis E

71732000

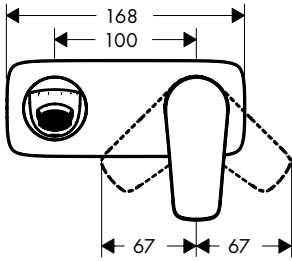
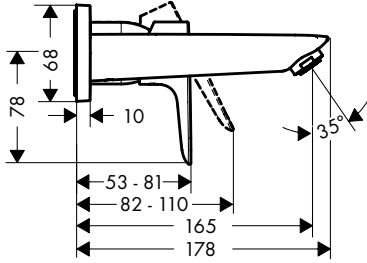

Talis E

71734000

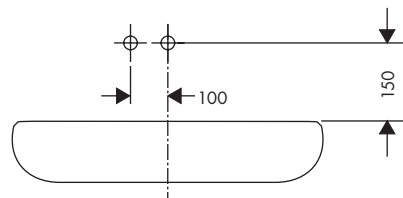
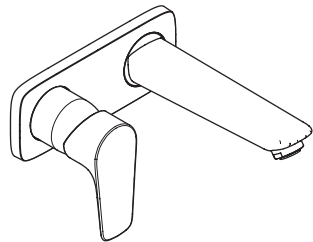
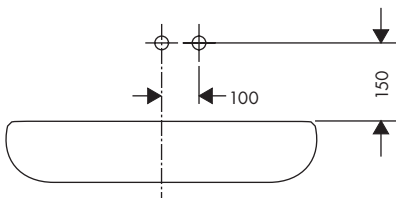
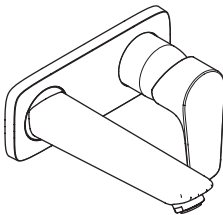
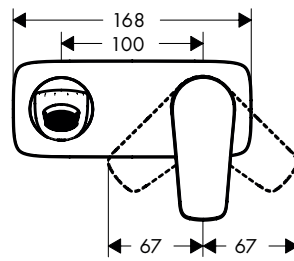
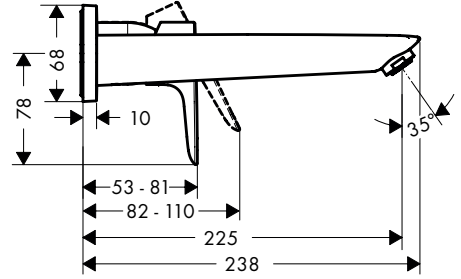



Talis S
72110000

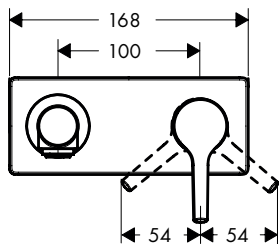
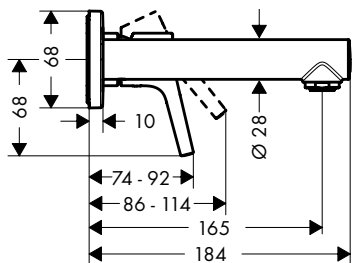

Talis S
72111000

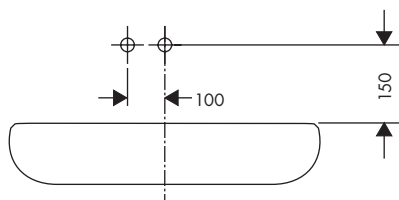
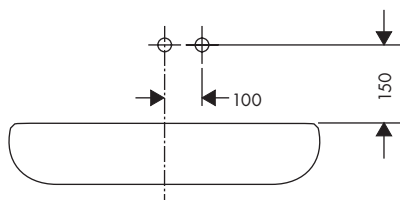
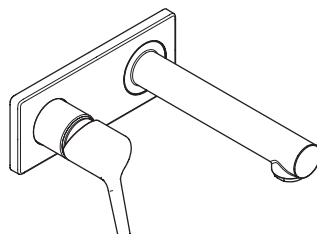
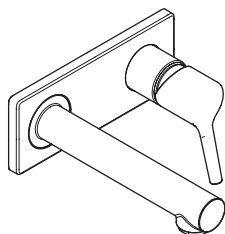
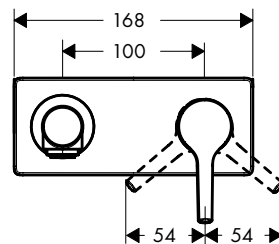
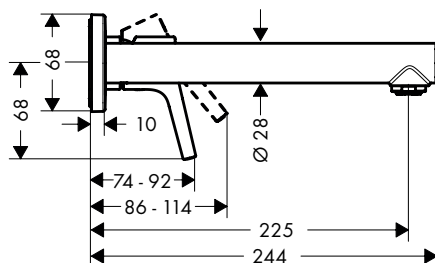



Metropol
32525000

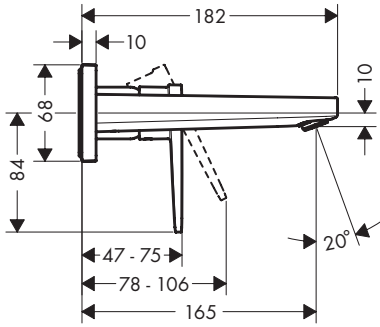

Metropol
32526000

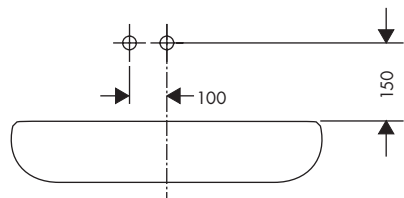
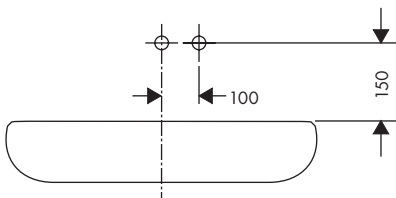
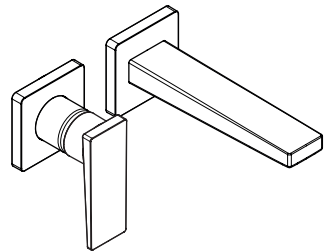
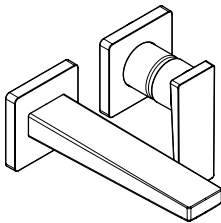
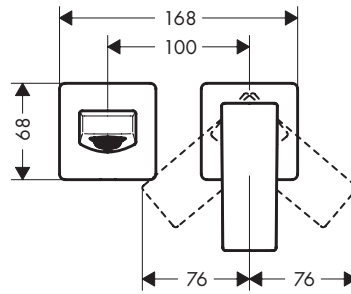
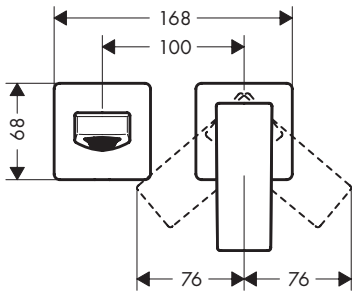
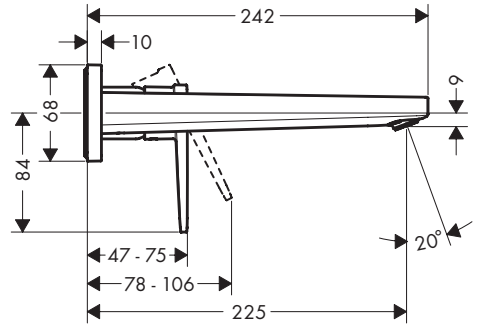



Metropol
74525000

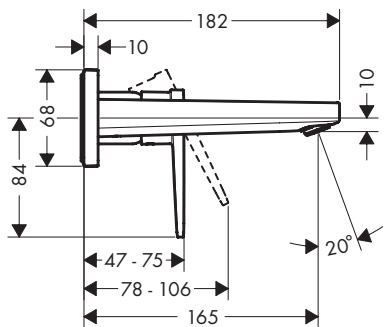

Metropol
74526000

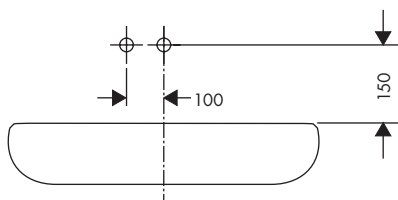
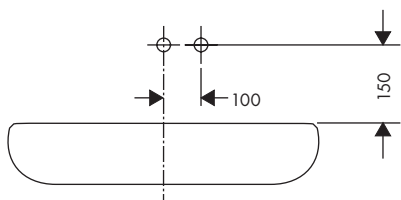
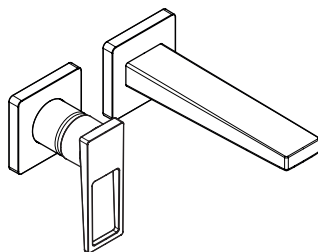
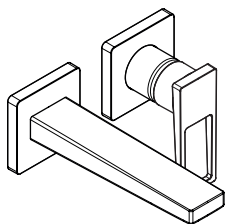
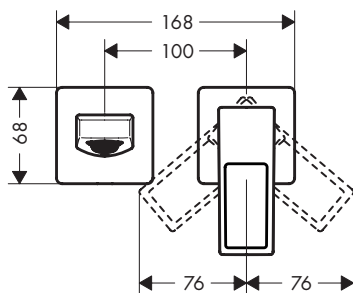
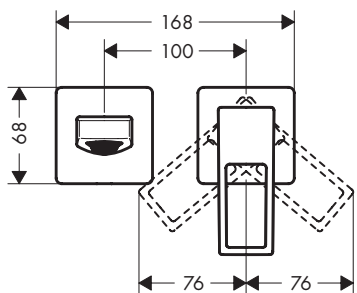
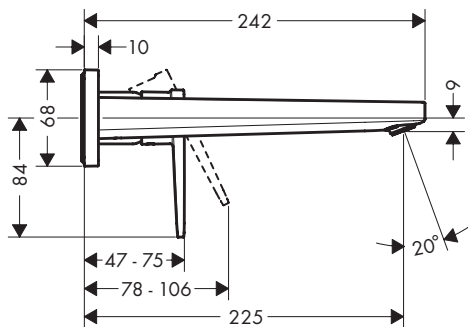



Finoris
76050XX0

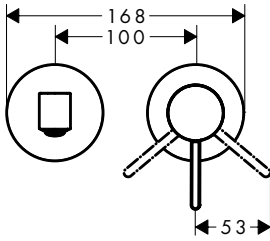
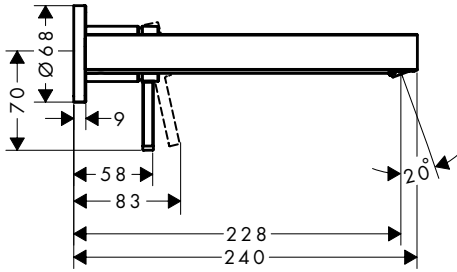

Finoris
76051XX0

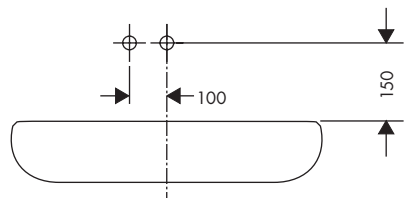
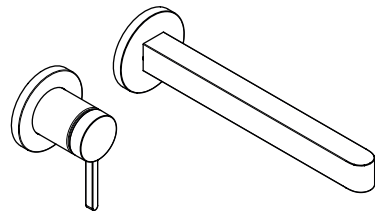
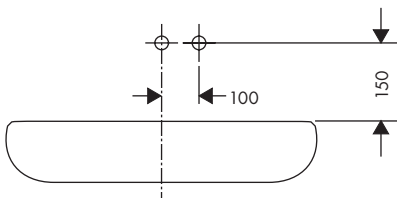
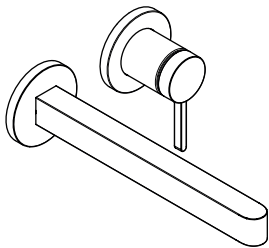
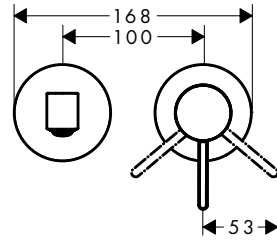
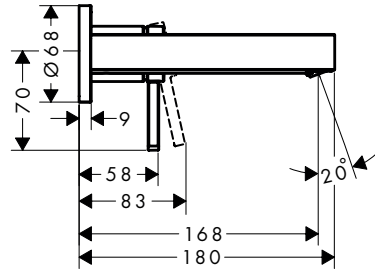



Vernis Blend

71576000

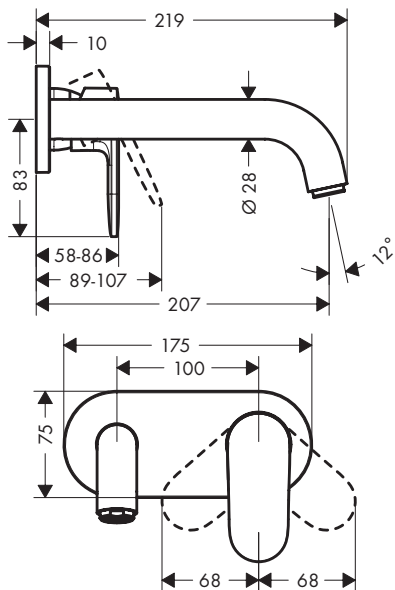

Vernis Shape

71578000

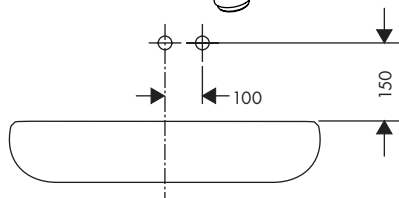
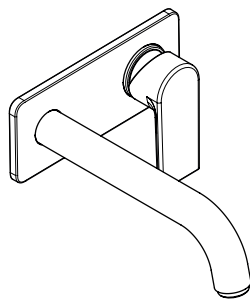
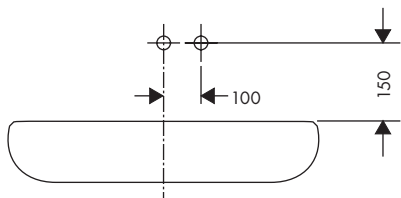
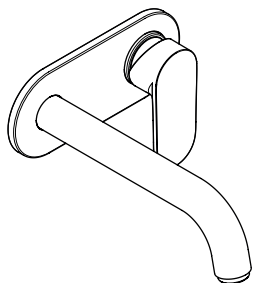
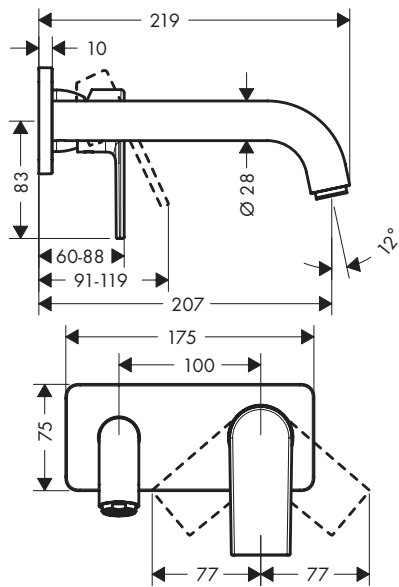



Rebris E
72568XX0

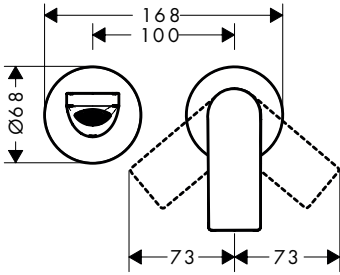
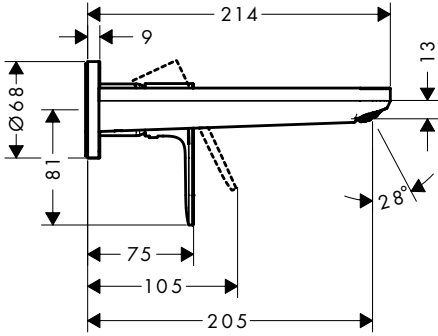

Rebris S
72528XX0

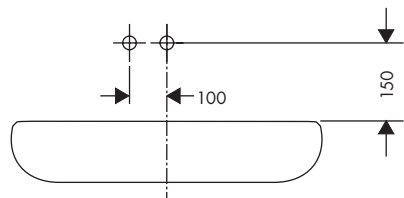
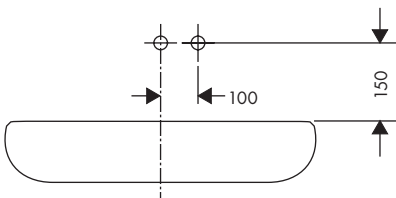
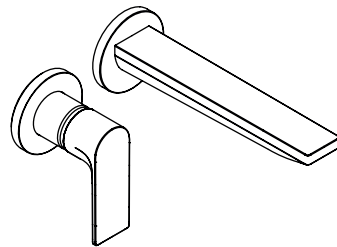
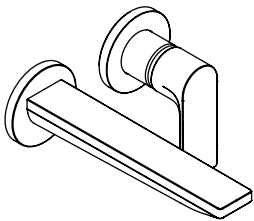
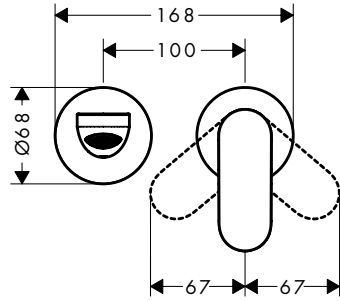
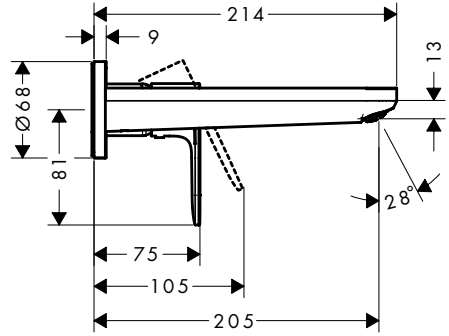



Vivenis
75050XX0

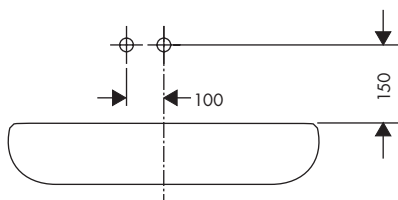
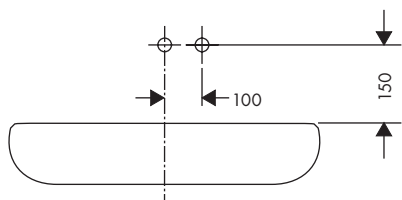
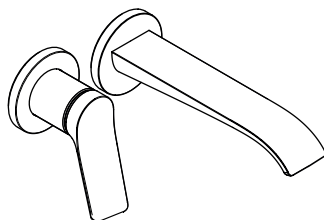
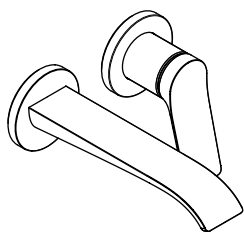
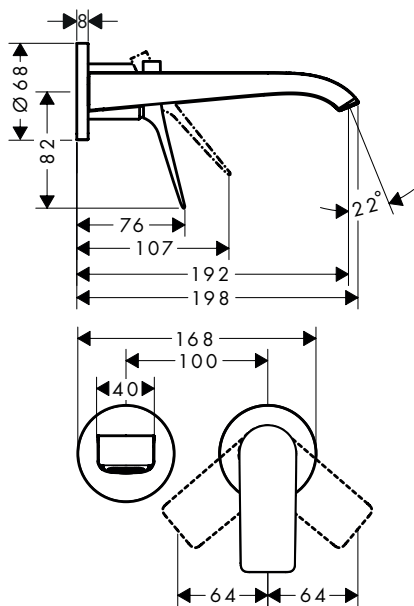



Tecturis E

73051XX0

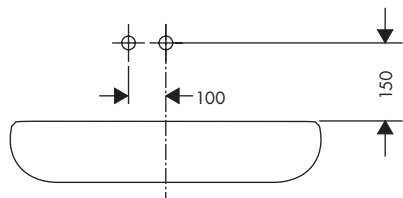
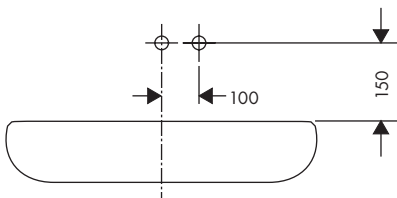
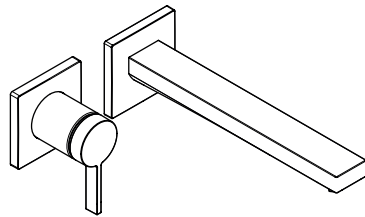
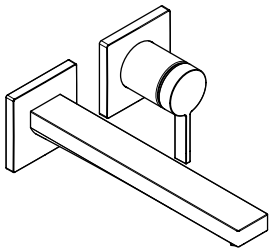
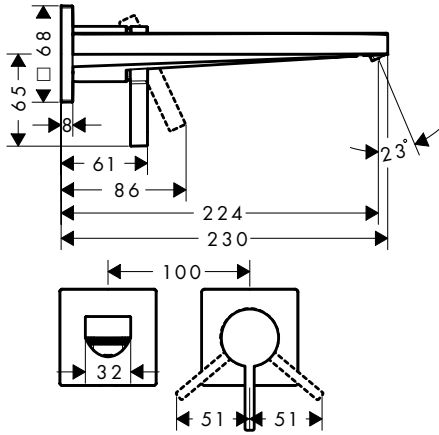



Tecturis S 73350XX0

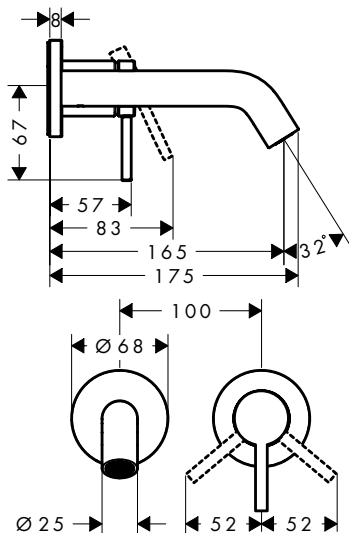

Tecturis S 73351XX0

