

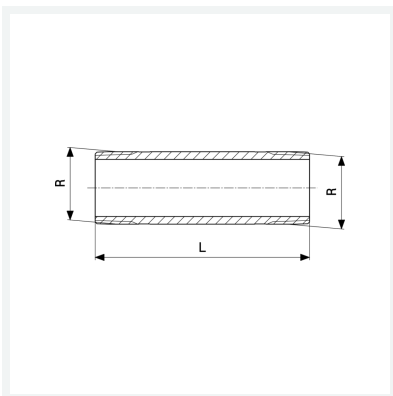

Langnippel
- R-Gewinde
Modell 3530

Artikel 282 431



Eigenschaften

Länge	L	100
Außengewinde kegelig	R	$\frac{3}{8}$
Länge	L	100 mm
Gewicht	124 g	
Volumen	71,04 cm ³	
Werkstoff	Rotguss oder Siliziumbronze	