

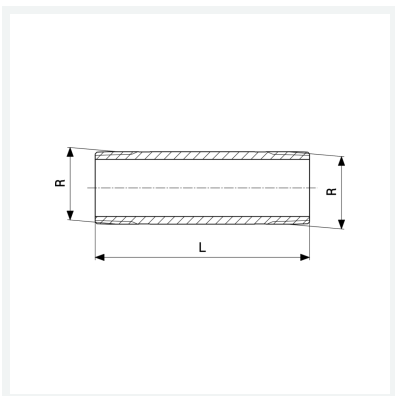

Langnippel
- R-Gewinde
Modell 3530

Artikel 318 413



Eigenschaften

Länge	L	140
Außengewinde kegelig	R	¾
Länge	L	140 mm
Gewicht	303,32 g	
Volumen	177,6 cm ³	
Werkstoff	Rotguss oder Siliziumbronze	