



INTERNATIONALE ZULASSUNGEN

EDELSTAHL AISI 316L

	Deutschland	 <small>IN PROGRESS</small>
	Frankreich *	
	Austria *	
	Norwegen	 <small>Norwegian Building Research Institute</small>
	Schweden	
	Niederlande	
	Schweiz	
	Finnland	
	Dänemark *	
	Russland	
	Italien	
	Tschechische Rep.	 ustanovením § 5 odst. 2 nařízení vlády č. 163/2002 <small>IN PROGRESS</small>

EDELSTAHL GAS AISI 316L

	Deutschland	
	Schweden	
	Austria *	

C-STAHL

	Deutschland	
	Frankreich *	
	Schweden	
	Russland	
	Tschechische Rep.	 ustanovením § 5 odst. 2 nařízení vlády č. 163/2002 <small>IN PROGRESS</small>

CUPRONICKEL



	Italien	
--	---------	--

Die Qualität der verwendeten Materialien, stetige Dichtungs- und Haltbarkeitstests und die Anwendung eines strengen Qualitätskontrollsystems haben dem Eurotubi Pressfitting System ermöglicht, die Konformität mit den strengsten europäischen Zertifikationen zu erhalten.



* Inhaber der Zulassung; unser Vertreter

INDEX

	EDELSTAHL AISI 316L	s. 2
	EDELSTAHL GAS AISI 316L	s. 14
	C-STAHl	s. 20
	ZUBEHÖR	s. 29
	ROHRE	s. 31

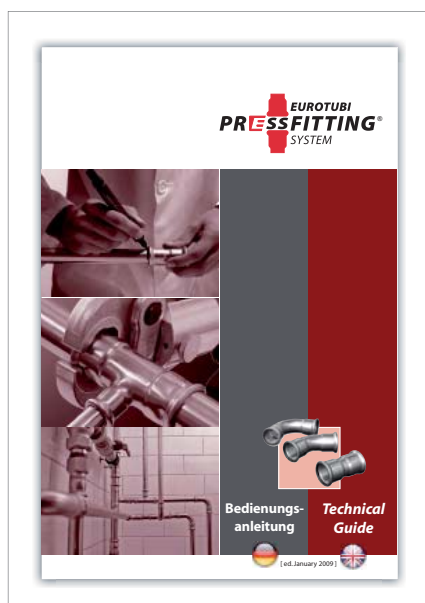

Zur korrekten Anwendung verweisen an unsere Bedienungsanleitung.

Muffe

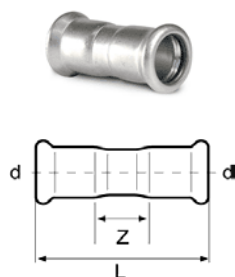

Art. Nr.	d	L	Z	Gewicht in g	€	Mind. Menge
S10AB	12		<i>bald verfügbar</i>			
S10AC	15	52	10	39		100
S10AD	18	52	10	44		100
S10AE	22	59	13	62		100
S10AF	28	61	13	78		100
S10AG	35	72	18	109		60
S10AH	42	79	15	147		30
S10AJ	54	90	16	205		30
S10AK	76,1	142	32	604		5
S10AL	88,9	163	37	837		5
S10AM	108	192	38	1.193		5

Schiebemuffe

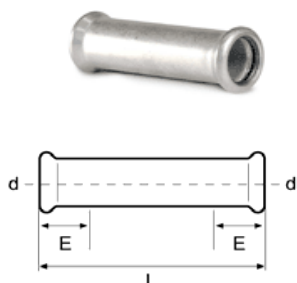

Art. Nr.	d	L	E	Gewicht in g	€	Mind. Menge
S11AB	12		<i>bald verfügbar</i>			
S11AC	15	71	24	47		100
S11AD	18	77	25	63		50
S11AE	22	82	27	85		50
S11AF	28	90	28	114		50
S11AG	35	99	31	149		50
S11AH	42	115	35	216		30
S11AJ	54	139	40	316		20
S11AK	76,1	230	60	874		5
S11AL	88,9	258	70	1.19		5
S11AM	108	305	80	1.775		5

Absatznippel

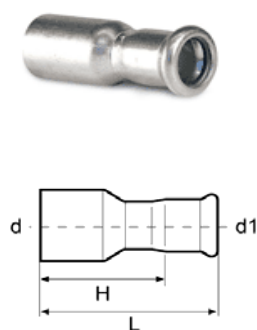

Art. Nr.	d - d1	L	H	Gewicht in g	€	Mind. Menge
S12CB	15-12		<i>bald verfügbar</i>			
S12DB	18-12		<i>bald verfügbar</i>			
S12DC	18-15	55	34	40		100
S12EB	22-12		<i>bald verfügbar</i>			
S12EC	22-15	60	39	45		100
S12ED	22-18	57	36	47		100
S12FC	28-15	72	51	56		80
S12FD	28-18	77	56	61		80
S12FE	28-22	67	44	65		100
S12GC	35-15	82	61	89		30
S12GD	35-18	87	66	96		30
S12GE	35-22	83	60	98		80
S12GF	35-28	73	49	112		80
S12HC	42-15	91	70	118		20
S12HD	42-18	96	75	126		20
S12HE	42-22	87	64	125		30
S12HF	42-28	98	74	140		30
S12HG	42-35	79	52	120		30
S12JC	54-15	110	89	197		15
S12JD	54-18	113	92	200		15
S12JE	54-22	107	84	191		15
S12JF	54-28	99	75	193		20
S12JG	54-35	128	101	237		20
S12JH	54-42	97	65	191		20
S12KH	76,1-42	151	119	425		5
S12KJ	76,1-54	140	103	451		5
S12LJ	88,9-54	156	119	586		5
S12LK	88,9-76,1	156	101	653		5
S12MJ	108-54	204	167	880		5
S12MK	108-76,1	196	141	978		5
S12ML	108-88,9	190	127	992		5

**Bogen 90°
2 Muffen**



R = 1,5 d

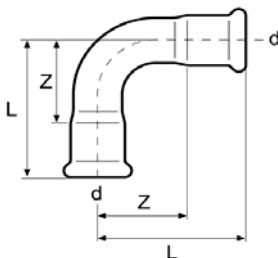

R = 1,2 d

Art. Nr.	d	L	Z	Gewicht in g	€	Mind. Menge
S20AB	12			<i>bald verfügbar</i>		
S20AC	15	48	27	57		100
S20AD	18	53	32	77		100
S20AE	22	60	37	97		100
S20AF	28	71	47	143		60
S20AG	35	87	60	198		60
S20AH	42	115	83	314		30
S20AJ	54	142	105	499		20

Art. Nr.	d	L	Z	Gewicht in g	€	Mind. Menge
S20ZG	35	75	48	173		60
S20ZH	42	89	57	261		30
S20ZJ	54	107	70	391		20
S20ZK	76,1	150	95	977		5
S20ZL	88,9	174	111	1.325		5
S20ZM	108	215	138	2.091		5

**Einsteckbogen 90°
1 Muffe**



R = 1,5 d

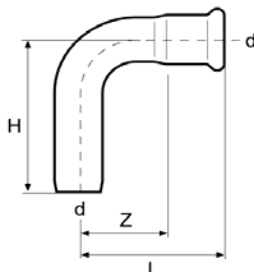

R = 1,2 d

Art. Nr.	d	L	H	Z	Gewicht in g	€	Mind. Menge
S21AB	12				<i>bald verfügbar</i>		
S21AC	15	48	56	27	58		100
S21AD	18	53	62	32	70		100
S21AE	22	60	68	37	98		100
S21AF	28	71	80	47	147		50
S21AG	35	87	93	60	200		50
S21AH	42	115	125	83	331		20
S21AJ	54	142	149	105	505		20

Art. Nr.	d	L	H	Z	Gewicht in g	€	Mind. Menge
S21ZG	35	75	83	48	179		50
S21ZH	42	89	97	57	260		20
S21ZJ	54	107	116	70	400		20
S21ZK	76,1	150	165	95	982		5
S21ZL	88,9	174	190	111	1.317		5
S21ZM	108	215	238	138	2.068		5

**Bogen 45°
2 Muffen**



R = 1,5 d

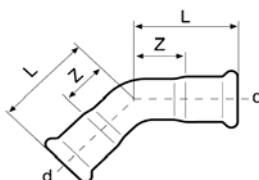

R = 1,2 d

Art. Nr.	d	L	Z	Gewicht in g	€	Mind. Menge
S22AB	12			<i>bald verfügbar</i>		
S22AC	15	37	16	49		100
S22AD	18	38	17	59		100
S22AE	22	44	21	81		100
S22AF	28	51	27	118		50
S22AG	35	59	32	161		50
S22AH	42	77	45	254		20
S22AJ	54	88	51	369		20

Art. Nr.	d	L	Z	Gewicht in g	€	Mind. Menge
S22ZG	35	49	22	152		50
S22ZH	42	63	31	216		20
S22ZJ	54	75	38	323		20
S22ZK	76,1	98	43	773		5
S22ZL	88,9	112	49	991		5
S22ZM	108	138	61	1.600		5

**Einsteckbogen 45°
1 Muffe**



R = 1,5 d

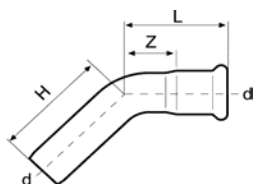

R = 1,2 d

Art. Nr.	d	L	H	Z	Gewicht in g	€	Mind. Menge
S23AB	12				<i>bald verfügbar</i>		
S23AC	15	37	48	16	53		100
S23AD	18	38	45	17	59		100
S23AE	22	44	53	21	85		100
S23AF	28	51	60	27	117		50
S23AG	35	59	66	32	160		50
S23AH	42	77	80	45	237		20
S23AJ	54	88	97	51	366		20
Art. Nr.	d	L	H	Z	Gewicht in g	€	Mind. Menge
S23ZG	35	49	51	22	155		50
S23ZH	42	63	72	31	203		20
S23ZJ	54	75	83	38	310		20
S23ZK	76,1	98	117	43	767		5
S23ZL	88,9	112	131	49	998		5
S23ZM	108	138	154	61	1.510		5

Übergangsmuffe I.G.

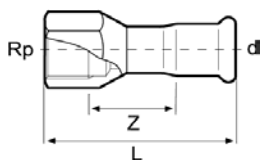

Art. Nr.	d - Rp	L	Z	Gewicht in g	€	Mind. Menge
S80PB	12-Rp $\frac{1}{2}$			<i>bald verfügbar</i>		
S80PC	15-Rp $\frac{1}{2}$	53	20	52		100
S80QC	15-Rp $\frac{3}{4}$	67	33	81		60
S80PD	18-Rp $\frac{1}{2}$	51	18	52		100
S80QD	18-Rp $\frac{3}{4}$	57	23	77		100
S80PE	22-Rp $\frac{1}{2}$	52	17	77		100
S80QE	22-Rp $\frac{3}{4}$	56	20	75		100
S80RE	22-Rp1	70	31	105		80
S80QF	28-Rp $\frac{3}{4}$	73	36	105		80
S80RF	28-Rp1	62	22	103		80
S80SF	28-Rp $\frac{1}{4}$	80	39	171		50
S80RG	35-Rp1	81	38	136		50
S80SG	35-Rp $\frac{1}{4}$	72	28	170		50
S80TG	35-Rp $\frac{1}{2}$	83	39	259		50
S80SH	42-Rp $\frac{1}{4}$	94	45	221		20
S80TH	42-Rp $\frac{1}{2}$	74	25	252		30
S80TJ	54-Rp $\frac{1}{2}$	106	52	328		20
S80VJ	54-Rp2	84	25	342		20

Übergangsmuffe A.G.

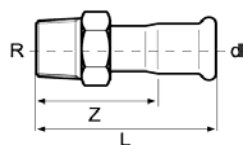

Art. Nr.	d - R	L	Z	Gewicht in g	€	Mind. Menge
S81PB	12-R $\frac{1}{2}$			<i>bald verfügbar</i>		
S81NC	15-R $\frac{3}{8}$	50	29	50		100
S81PC	15-R $\frac{1}{2}$	52	31	52		100
S81QC	15-R $\frac{3}{4}$	64	43	66		50
S81PD	18-R $\frac{1}{2}$	52	31	53		100
S81QD	18-R $\frac{3}{4}$	54	33	67		50
S81PE	22-R $\frac{1}{2}$	68	45	73		100
S81QE	22-R $\frac{3}{4}$	58	35	74		100
S81RE	22-R1	72	49	116		100
S81QF	28-R $\frac{3}{4}$	73	49	100		80
S81RF	28-R1	62	38	115		100
S81SF	28-R $\frac{1}{4}$	79	55	166		50
S81RG	35-R1	82	55	148		50
S81SG	35-R $\frac{1}{4}$	70	43	165		50
S81TG	35-R $\frac{1}{2}$	84	57	198		30
S81SH	42-R $\frac{1}{4}$	93	61	216		20
S81TH	42-R $\frac{1}{2}$	75	43	204		20
S81TJ	54-R $\frac{1}{2}$	105	68	271		20
S81VJ	54-R2	87	50	368		20
S81XK	76,1-R 2 $\frac{1}{2}$	125	70	820		5
S81YL	88,9-R 3	138	75	1.158		5

Absatzmuffe A.G.

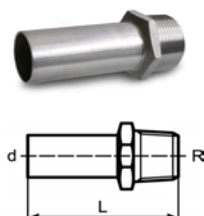

Art. Nr.	d - R	L	Gewicht in g	€	Mind. Menge
S87PC	15-R $\frac{1}{2}$	70	55		100
S87PD	18-R $\frac{1}{2}$	70	57		100
S87QE	22-R $\frac{3}{4}$	75	80		100
S87RF	28-R1	75	120		80
S87SG	35-R1 $\frac{1}{4}$	80	170		80
S87TH	42-R1 $\frac{1}{2}$	91	220		50
S87VJ	54-R2	102	384		50

Absatzmuffe I.G.

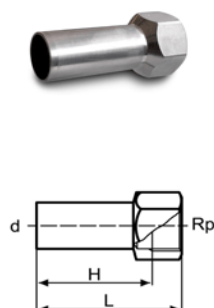

Art. Nr.	d - Rp	H	L	Gewicht in g	€	Mind. Menge
S86PC	15-Rp $\frac{1}{2}$	136	148	95		100
S86PD	18-Rp $\frac{1}{2}$	136	148	108		100
S86QD	18-Rp $\frac{3}{4}$	135	148	130		100
S86PE	22-Rp $\frac{1}{2}$	140	152	150		100
S86QE	22-Rp $\frac{3}{4}$	139	152	148		100
S86RF	28-Rp1	94	110	145		80
S86SG	35-Rp1 $\frac{1}{4}$	93	110	210		80
S86TH	42-Rp1 $\frac{1}{2}$	93	110	300		50
S86VJ	54-Rp2	98	120	408		50

Übergangsbogen 90° I.G.

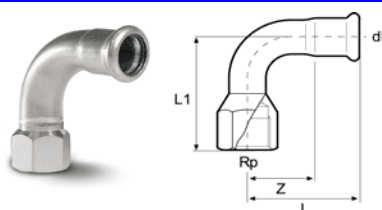

Part No.	d - Rp	L	L1	Z	Gewicht in g	€	Mind. Menge
S82PC	15-Rp $\frac{1}{2}$	48	58	27	76		20
S82PD	18-Rp $\frac{1}{2}$	53	59	32	84		20
S82QE	22-Rp $\frac{3}{4}$	60	68	37	123		20
S82RF	28-Rp1	71	81	47	172		20
S82SG	35-Rp1 $\frac{1}{4}$	87	95	60	267		15

Übergangsbogen 90° A.G.

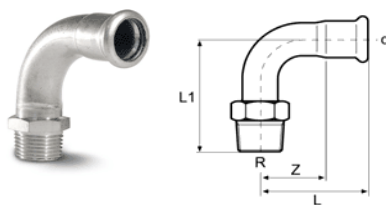

Art. Nr.	d - R	L	L1	Z	Gewicht in g	€	Mind. Menge
S83PC	15-R $\frac{1}{2}$	48	58	27	75		20
S83PD	18-R $\frac{1}{2}$	53	61	32	81		20
S83QE	22-R $\frac{3}{4}$	60	69	37	119		20
S83RF	28-R1	71	81	47	184		20
S83SG	35-R1 $\frac{1}{4}$	87	94	60	262		15
S83TH	42-R1 $\frac{1}{2}$	115	116	83	376		15
S83VJ	54-R2	142	143	105	667		15

Übergangsbogen 45° A.G.

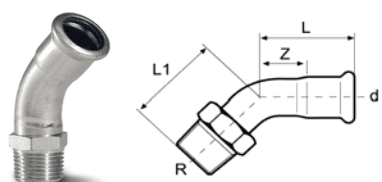

Part No.	d - R	L	L1	Z	Gewicht in g	€	Mind. Menge
S85PC	15-R $\frac{1}{2}$	37	38	16	64		20
S85PD	18-R $\frac{1}{2}$	38	46	17	73		20
S85QE	22-R $\frac{3}{4}$	44	51	21	102		20

Übergangswinkel 90° A.G.

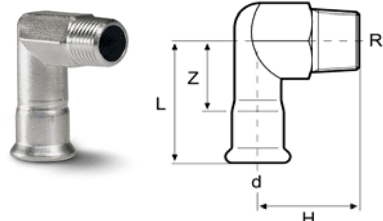

Art. Nr.	d - R	L	H	Z	Gewicht in g	€	Mind. Menge
S31PB	12-R $\frac{1}{2}$				<i>bald verfügbar</i>		
S31PC	15-R $\frac{1}{2}$	53	36	32	91		80
S31QC	15-R $\frac{3}{4}$	62	38	41	137		50
S31PD	18-R $\frac{1}{2}$	51	36	30	98		50
S31QD	18-R $\frac{3}{4}$	67	37	46	143		30
S31QE	22-R $\frac{3}{4}$	58	40	35	145		50
S31RF	28-R1	63	44	39	245		50
S31SG	35-R1 $\frac{1}{4}$	71	48	44	338		30
S31TH	42-R1 $\frac{1}{2}$	81	53	49	425		15
S31VJ	54-R2	92	59	55	716		15

Übergangswinkel 90° I.G.

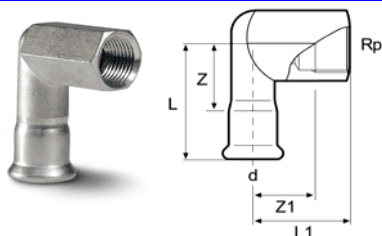

Art. Nr.	d - Rp	L	L1	Z	Z1	Gewicht in g	€	Mind. Menge
S30PB	12-Rp $\frac{1}{2}$					<i>bald verfügbar</i>		
S30PC	15-Rp $\frac{1}{2}$	53	36	32	24	121		80
S30PD	18-Rp $\frac{1}{2}$	52	39	31	27	118		60
S30QE	22-Rp $\frac{3}{4}$	57	46	34	33	180		50
S30RF	28-Rp1	71	54	47	38	329		50
S30SG	35-Rp1 $\frac{1}{4}$	72	62	45	45	455		30

Winkel 90° I.G. mit einseitigem Einschleibende

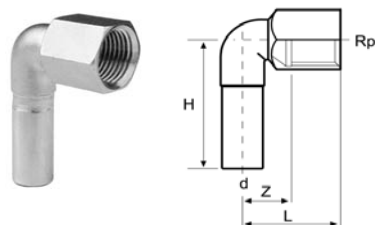

Art. Nr.	d - Rp	L	H	Z	Gewicht in g	€	Mind. Menge
S34PC	15-Rp $\frac{1}{2}$	35	53	23	66		50

Deckenwinkel 90° I.G.

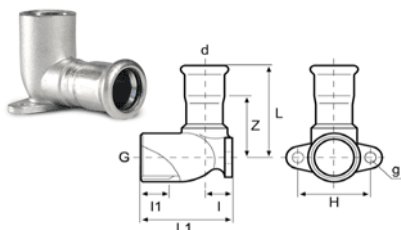

Art. Nr.	d - G (ISO 228)	L	L1	Z	I	I1	H	g	Gewicht in g	€	Mind. Menge
S32PB	12-G $\frac{1}{2}$								<i>bald verfügbar</i>		
S32PC	15-G $\frac{1}{2}$	46	43	25	12	12	34	5	104		80
S32PD	18-G $\frac{1}{2}$	47	44	26	13	12	34	6	100		60
S32QE	22-G $\frac{3}{4}$	52	51	29	16	13	40	6	147		60

Deckenwinkel 90° I.G. Lang

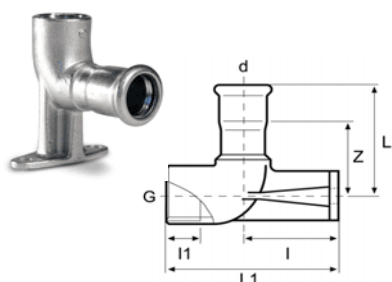

Art. Nr.	d - G (ISO 228)	L	I	L1	Z	I1	Gewicht in g	€	Mind. Menge
S33PC	15-G $\frac{1}{2}$	46	36	65	25	12	148		50
S33PD	18-G $\frac{1}{2}$	47	36	65	26	12	143		50
S33QE	22-G $\frac{3}{4}$	52	32	65	29	13	176		50

T-Stück

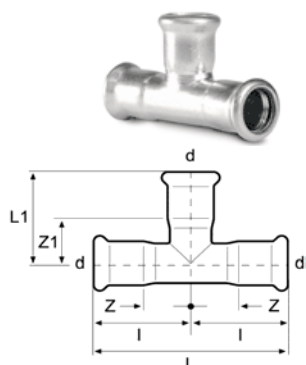

Red.T-Stück

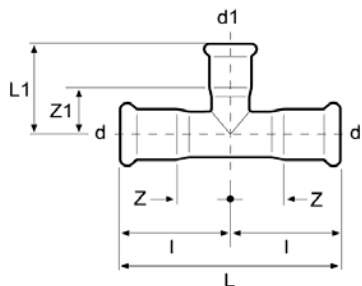

Art. Nr.	d	L	L1	Z	Z1	I	Gewicht in g	€	Mind. Menge
S40AB	12						<i>bald verfügbar</i>		
S40AC	15	74	35	16	14	37	67		100
S40AD	18	80	35	19	14	40	84		100
S40AE	22	82	40	18	17	41	112		100
S40AF	28	92	45	22	21	46	149		80
S40AG	35	102	55	24	28	51	189		50
S40AH	42	118	61	27	29	59	275		20
S40AJ	54	142	72	34	35	71	382		20
S40AK	76,1	232	115	61	60	116	1.192		5
S40AL	88,9	262	127	68	64	131	1.617		5
S40AM	108	312	155	79	78	156	2.450		5

Art. Nr.	d - d1 - d	L	L1	Z	Z1	I	Gewicht in g	€	Mind. Menge
S41BC	15-12-15						<i>bald verfügbar</i>		
S41BD	18-12-18						<i>bald verfügbar</i>		
S41CD	18-15-18	80	36	19	15	40	83		100
S41BE	22-12-22						<i>bald verfügbar</i>		
S41CE	22-15-22	82	39	18	18	41	98		100
S41DE	22-18-22	82	38	18	17	41	105		100
S41CF	28-15-28	92	42	22	21	46	130		80
S41DF	28-18-28	92	42	22	21	46	132		80
S41EF	28-22-28	92	45	22	22	46	140		80
S41CG	35-15-35	102	45	24	24	51	164		50
S41DG	35-18-35	102	45	24	24	51	164		50
S41EG	35-22-35	102	46	24	23	51	172		50
S41FG	35-28-35	102	48	24	24	51	175		50
S41CH	42-15-42	118	48	27	27	59	213		20
S41DH	42-18-42	118	48	27	27	59	236		20
S41EH	42-22-42	118	51	27	28	59	239		30
S41FH	42-28-42	118	53	27	29	59	240		30
S41GH	42-35-42	118	60	27	33	59	242		30
S41CJ	54-15-54	142	56	34	35	71	326		15
S41DJ	54-18-54	142	55	34	34	71	327		15
S41EJ	54-22-54	142	57	34	34	71	325		20
S41FJ	54-28-54	142	60	34	36	71	348		15
S41GJ	54-35-54	142	66	34	39	71	344		15
S41HJ	54-42-54	142	64	34	32	71	368		15
S41EK	76,1-22-76,1	232	68	61	45	116	942		5
S41FK	76,1-28-76,1	232	71	61	47	116	956		5
S41GK	76,1-35-76,1	232	75	61	48	116	968		5
S41HK	76,1-42-76,1	232	79	61	47	116	981		5
S41JK	76,1-54-76,1	232	80	61	43	116	1.067		5
S41EL	88,9-22-88,9	262	76	68	53	131	1.256		5
S41FL	88,9-28-88,9	262	76	68	52	131	1.244		5
S41GL	88,9-35-88,9	262	83	68	56	131	1.267		5
S41HL	88,9-42-88,9	262	85	68	53	131	1.271		5
S41JL	88,9-54-88,9	262	93	68	56	131	1.297		5
S41KL	88,9-76,1-88,9	262	116	68	61	131	1.479		5
S41EM	108-22-108	312	85	79	62	156	1.919		5
S41FM	108-28-108	312	88	79	64	156	1.939		5
S41GM	108-35-108	312	94	79	67	156	1.955		5
S41HM	108-42-108	312	96	79	64	156	1.886		5
S41JM	108-54-108	312	102	79	65	156	1.967		5
S41KM	108-76,1-108	312	125	79	70	156	2.147		5
S41LM	108-88,9-108	312	135	79	72	156	2.255		5

T-Stück mit I.G. Abgang

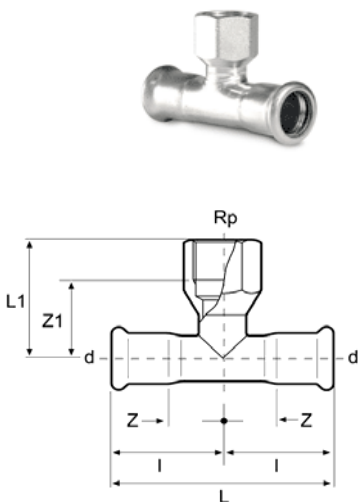

Art. Nr.	d - Rp	L	L1	Z	Z1	I	Gewicht in g	€	Mind. Menge
S42NB	12-Rp $\frac{1}{2}$ -12	<i>bald verfügbar</i>							
S42PC	15-Rp $\frac{1}{2}$ -15	74	37	16	25	37	83		100
S42PD	18-Rp $\frac{1}{2}$ -18	80	39	19	27	40	95		80
S42QD	18-Rp $\frac{3}{4}$ -18	80	43	19	30	40	118		50
S42PE	22-Rp $\frac{1}{2}$ -22	82	41	18	29	41	117		100
S42QE	22-Rp $\frac{3}{4}$ -22	82	41	18	28	41	131		80
S42PF	28-Rp $\frac{1}{2}$ -28	92	44	22	32	46	144		80
S42QF	28-Rp $\frac{3}{4}$ -28	92	45	22	32	46	159		50
S42RF	28-Rp1-28	92	48	22	32	46	175		30
S42PG	35-Rp $\frac{1}{2}$ -35	102	48	24	36	51	178		50
S42QG	35-Rp $\frac{3}{4}$ -35	102	48	24	35	51	189		50
S42SG	35-Rp1 $\frac{1}{4}$ -35	102	57	24	40	51	255		20
S42PH	42-Rp $\frac{1}{2}$ -42	118	46	27	34	59	240		20
S42QH	42-Rp $\frac{3}{4}$ -42	118	52	27	39	59	254		20
S42TH	42-Rp1 $\frac{1}{2}$ -42	118	59	27	42	59	384		20
S42PJ	54-Rp $\frac{1}{2}$ -54	142	55	34	43	71	362		15
S42QJ	54-Rp $\frac{3}{4}$ -54	142	58	34	45	71	364		15
S42VJ	54-Rp2-54	142	69	34	47	71	523		15
S42QK	76,1-Rp $\frac{3}{4}$ -76,1	232	68	61	55	116	1.009		5
S42VK	76,1-Rp2-76,1	232	81	61	59	116	1.194		5
S42QL	88,9-Rp $\frac{3}{4}$ -88,9	262	87	68	74	131	1.210		5
S42VL	88,9-Rp2-88,9	262	88	68	66	131	1.450		5
S42QM	108-Rp $\frac{3}{4}$ -108	312	86	79	73	156	1.956		5
S42VM	108-Rp2-108	312	98	79	76	156	2.118		5

T-Stück mit A.G. Abgang

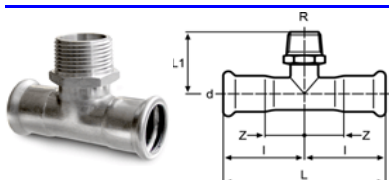

Art. Nr.	d - R	L	L1	Z	Z1	I	Gewicht in g	€	Mind. Menge
S43PC	15-R $\frac{1}{2}$ -15	74	38	16	15	37	75		100
S43PD	18-R $\frac{1}{2}$ -18	80	40	19	15	40	80		100
S43QE	22-R $\frac{3}{4}$ -22	82	43	18	17	41	105		100
S43RF	28-R1-28	92	50	22	21	46	130		80
S43SG	35-R1 $\frac{1}{4}$ -35	102	56	24	28	51	170		50

Verschieben T-Stück

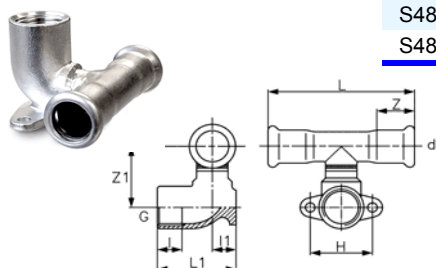

Art. Nr.	d - G (ISO 228)	L	L1	Z	Z1	H	I	I1	Gewicht in g	€	Mind. Menge
S48PC	15-G $\frac{1}{2}$	74	43	21	31	34	12	13	130		100
S48PD	18-G $\frac{1}{2}$	80	43	21	33	34	12	13	150		100

Drei Weg Uebergang mit Einseitig I.G.

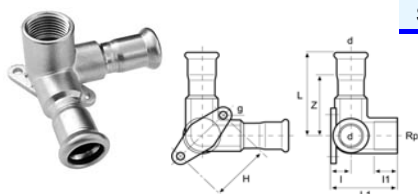

Art. Nr.	d - Rp	L	L1	I	I1	Z	H	g	Gewicht in g	€	Mind. Menge
S36PC	15-Rp $\frac{1}{2}$	56	44	15	12	35	39	5	166		50

Flaschenschluss

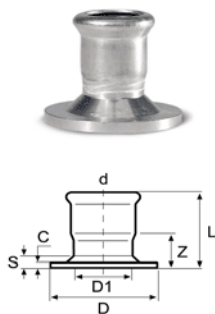

Art. Nr.	d	L	D	D1	Z	C	S	Gewicht in g	€	Mind. Menge
S55AC	15	38	34	14	17	4	10	57		20
S54AC	15	38	45	14	17	4	10	78		20
S55AD	18	38	39	17	17	4	10	69		20
S54AD	18	38	45	17	17	4	10	82		20
S55AE	22	39	39	21	16	4	9	70		20
S54AE	22	39	45	21	16	4	9	83		20
S54AF	28	42	45	27	18	4	9	89		20
S54AG	35	46	56	32	19	4	9	127		15
S54AH	42	50	62	39	18	4	9	156		15
S54AJ	54	56	78	51	19	4	10	229		15

Übergangsflansch PN 16

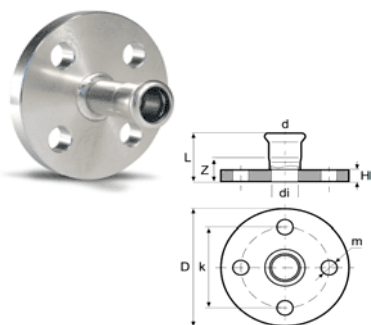

Art. Nr.	d	D	di	L	H	m	k	Z	Gewicht in g	€	Mind. Menge
S52AC	15	95	14	59	11	14	65	33	582		20
S52AD	18	95	17	57	11	14	65	39	590		20
S52AE	22	105	21	59	12	14	75	39	783		20
S52AF	28	115	27	65	14	14	85	47	1.091		20
S52AG	35	140	32	70	15	18	100	52	1.717		20
S52AH	42	150	39	77	16	18	110	59	2.088		15
S52AJ	54	165	51	86	18	18	125	75	2.834		15
S52AK	76,1	185	72	126	18	18	145	71	3.546		5
S52AL	88,9	200	85	147	20	18	160	84	4.344		5
S52AM	108	220	104	167	20	18	180	90	5.251		5

Verschlussstopfen

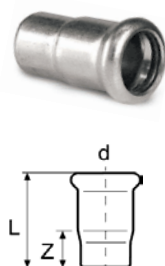

Art. Nr.	d	L	Z	Gewicht in g	€	Mind. Menge
S50AC	15	37	16	27		100
S50AD	18	40	19	33		50
S50AE	22	41	18	44		50
S50AF	28	46	22	63		50
S50AG	35	51	24	81		50
S50AH	42	59	27	119		20
S50AJ	54	72	35	171		20
S50AK	76,1	95	40	427		10
S50AL	88,9	107	44	559		5
S50AM	108	127	50	821		5

Kappe

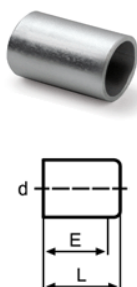

Art. Nr.	d	E	L	Gewicht in g	€	Mind. Menge
S51AC	15	33	42	26		100
S51AD	18	33	40	32		50
S51AE	22	34	43	43		50
S51AF	28	36	47	58		50
S51AG	35	40	49	78		50
S51AH	42	44	55	107		20
S51AJ	54	49	62	159		20
S51AK	76,1	65	75	360		10
S51AL	88,9	72	90	500		5
S51AM	108	87	103	708		5

**Anschlussverschraubung
Flachdichtung in EPDM
Messing-oder Inoxmutter**



NEU!

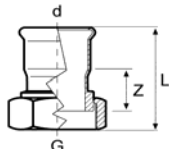

Für die Preise mit Edelstahlmutter wenden Sie sich bitte an unsere Vertriebsabt., unsere Teile-Nr. S61

Art. Nr.	G - d (ISO 228)	Überwurf- mutter	L	Z	Gewicht in g	€	Mind. Menge
S60PC	G $\frac{1}{2}$ -12	Messing	<i>bald verfügbar</i>				
S60QC	G $\frac{3}{4}$ -15	Messing	51	21	87		50
S60SC	G $\frac{1}{4}$ -15	Messing	53	21	175		15
S60QD	G $\frac{3}{4}$ -18	Messing	52	22	85		50
S60RE	G1-22	Messing	53	19	104		50
S60SF	G $\frac{1}{4}$ -28	Messing	54	20	159		50
S60TF	G $\frac{1}{2}$ -28	Messing	57	22	242		50
S60TG	G $\frac{1}{2}$ -35	Messing	64	26	267		20
S60UH	G $\frac{1}{4}$ -42	Messing	69	24	325		20
S60WJ	G $\frac{2}{8}$ -54	Messing	78	27	476		20

**Übergangverschraubung I.G.
Flachdichtung EPDM,
Messing-oder Inoxmutter**



NEU!

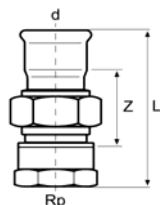

Für die Preise mit Edelstahlmutter wenden Sie sich bitte an unsere Vertriebsabt., unsere Teile-Nr. S63

Art. Nr.	d - Rp	Überwurf- mutter	L	Z	Gewicht in g	€	Mind. Menge
S62PC	15-Rp $\frac{1}{2}$	Messing	73	40	145		15
S62QC	15-Rp $\frac{3}{4}$	Messing	75	41	182		15
S62PD	18-Rp $\frac{1}{2}$	Messing	72	39	145		15
S62QD	18-Rp $\frac{3}{4}$	Messing	74	40	180		15
S62QE	22-Rp $\frac{3}{4}$	Messing	76	40	212		15
S62RE	22-Rp1	Messing	79	40	242		15
S62RF	28-Rp1	Messing	83	43	398		15
S62SG	35-Rp $\frac{1}{4}$	Messing	93	49	467		15
S62TH	42-Rp $\frac{1}{2}$	Messing	96	47	562		15
S62VJ	54-Rp2	Messing	113	54	973		15

**Übergangverschraubung A.G.
Flachdichtung EPDM
Messing-oder Inoxmutter**



NEU!

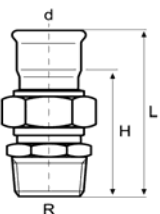

Für die Preise mit Edelstahlmutter wenden Sie sich bitte an unsere Vertriebsabt., unsere Teile-Nr. S65

Art. Nr.	d - R	Überwurf- mutter	L	H	Gewicht in g	€	Mind. Menge
S64PC	15-R $\frac{1}{2}$	Messing	76	55	147		15
S64QC	15-R $\frac{3}{4}$	Messing	80	59	166		15
S64PD	18-R $\frac{1}{2}$	Messing	76	55	148		15
S64QD	18-R $\frac{3}{4}$	Messing	79	58	167		15
S64PE	22-R $\frac{1}{2}$	Messing	80	57	239		15
S64QE	22-R $\frac{3}{4}$	Messing	82	59	222		15
S64RE	22-R1	Messing	86	63	256		15
S64RF	28-R1	Messing	88	64	360		15
S64SG	35-R $\frac{1}{4}$	Messing	100	73	544		15
S64TH	42-R $\frac{1}{2}$	Messing	106	74	628		15
S64VJ	54-R2	Messing	122	85	1.008		15

**Doppelanschlussverschraubung
Flachdichtung EPDM
Messing-oder Inoxmutter**



NEU!

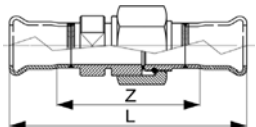

Für die Preise mit Edelstahlmutter wenden Sie sich bitte an unsere Vertriebsabt., unsere Teile-Nr. S68

Art. Nr.	G - d (ISO 228)	Überwurf- mutter	L	Z	Gewicht in g	€	Mind. Menge
S66QC	G $\frac{3}{4}$ -15	Messing	97	55	170		15
S66QD	G $\frac{3}{4}$ -18	Messing	97	55	165		15
S66RE	G1-22	Messing	105	59	222		15
S66SF	G $\frac{1}{4}$ -28	Messing	111	63	345		15
S66TG	G $\frac{1}{2}$ -35	Messing	124	70	540		15
S66UH	G $\frac{1}{4}$ -42	Messing	134	70	640		15
S66WJ	G $\frac{2}{8}$ -54	Messing	144	70	970		15

Passbogen 15°

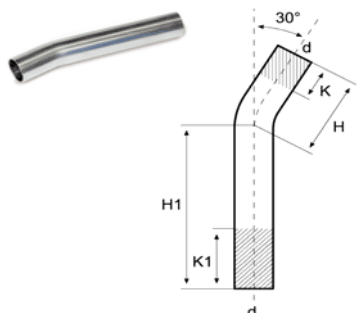

Art. Nr.	d	H1	H	K	K1	Gewicht in g	€	Mind. Menge
S75AB	12	<i>bald verfügbar</i>						
S75AC	15	122	60	21	83	76		30
S75AD	18	128	55	15	88	93		30
S75AE	22	124	50	7	81	110		30
S75AF	28	136	45	7	47	146		20
S75AG	35	234	62	30	110	381		15
S75AH	42	276	94	44	144	558		10
S75AJ	54	337	117	65	165	869		10
S75AK	76,1	230	226	65	65	1.607		5
S75AL	88,9	260	240	80	80	2.109		5
S75AM	108	291	222	95	95	2.546		5

Passbogen 30°

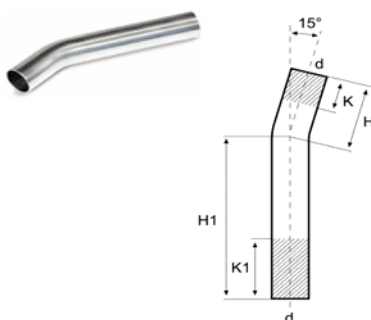

Art. Nr.	d	H1	H	K	K1	Gewicht in g	€	Mind. Menge
S74AB	12	<i>bald verfügbar</i>						
S74AC	15	122	60	21	83	76		30
S74AD	18	128	55	16	89	93		30
S74AE	22	124	50	6	80	110		30
S74AF	28	130	54	7	47	144		20
S74AG	35	218	80	30	110	382		15
S74AH	42	274	98	44	144	560		10
S74AJ	54	324	137	65	165	905		10
S74AK	76,1	200	202	66	66	1.410		5
S74AL	88,9	262	264	80	80	2.183		5
S74AM	108	259	272	95	95	2.622		5

Passbogen 45°

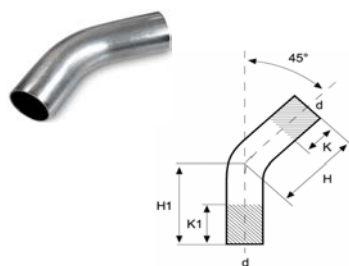

Art. Nr.	d	H1	H	K	K1	Gewicht in g	€	Mind. Menge
S73AB	12	<i>bald verfügbar</i>						
S73AC	15	120	62	19	77	76		30
S73AD	18	124	58	16	82	93		30
S73AE	22	120	56	7	71	111		30
S73AF	28	122	58	2	66	146		20
S73AG	35	206	94	20	132	380		15
S73AH	42	262	114	1	149	576		10
S73AJ	54	321	146	37	212	928		10
S73AK	76,1	225	225	69	69	1.577		5
S73AL	88,9	267	267	103	103	2.323		5
S73AM	108	293	293	66	66	2.901		5

Passbogen 60°

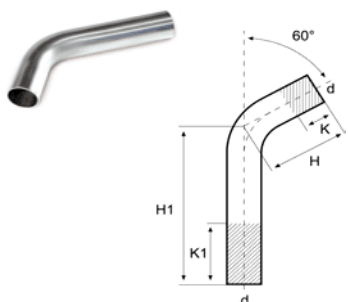

Art. Nr.	d	H1	H	K	K1	Gewicht in g	€	Mind. Menge
S72AB	12	<i>bald verfügbar</i>						
S72AC	15	122	60	21	83	76		30
S72AD	18	122	62	16	76	94		30
S72AE	22	118	60	5	63	112		30
S72AF	28	116	71	7	47	140		20
S72AG	35	226	101	30	110	383		15
S72AH	42	251	124	44	145	564		10
S72AJ	54	308	162	65	165	889		10
S72AK	76,1	219	223	70	70	1.479		5
S72AL	88,9	250	257	80	80	1.996		5
S72AM	108	288	298	95	95	2.780		5

Passbogen 75°

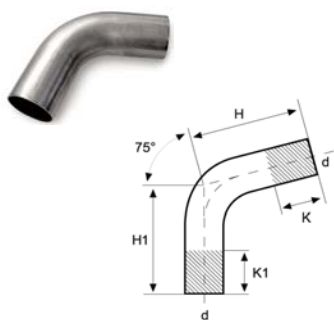

Art. Nr.	d	H1	H	K	K1	Gewicht in g	€	Mind. Menge
S71AB	12	<i>bald verfügbar</i>						
S71AC	15	117	66	22	73	77		30
S71AD	18	120	65	17	72	94		30
S71AE	22	118	64	9	63	114		30
S71AF	28	114	71	7	50	150		20
S71AG	35	200	110	26	119	393		15
S71AH	42	251	137	44	158	595		10
S71AJ	54	305	178	60	187	960		10
S71AK	76,1	240	240	62	62	1.682		5
S71AL	88,9	280	280	90	90	2.436		5
S71AM	108	345	345	60	60	3.416		5

Passbogen 90°

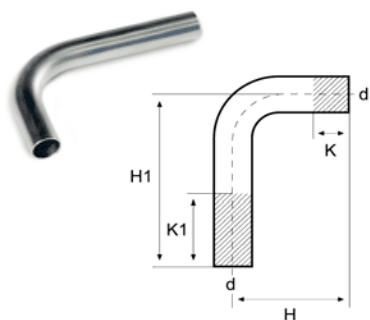

Art. Nr.	d	H1	H	K	K1	Gewicht in g	€	Mind. Menge
S70AB	12	<i>bald verfügbar</i>						
S70AC	15	120	70	22	72	59		40
S70AD	18	120	70	17	67	75		40
S70AE	22	120	70	9	59	102		20
S70AF	28	125	97	7	47	153		20
S70AG	35	200	120	30	110	183		10
S70AH	42	250	160	44	144	565		10
S70AJ	54	305	200	65	165	868		10
S70AK	76,1	250	250	62	62	1.752		5
S70AL	88,9	291	291	90	90	2.532		5
S70AM	108	364	364	45	45	3.604		5

Überbogen

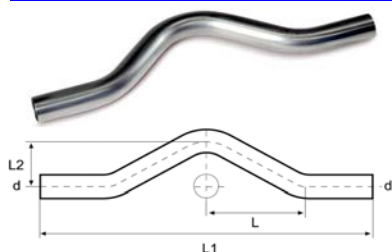

Art. Nr.	d	L1	L2	L	Gewicht in g	€	Mind. Menge	
S76AB	12	<i>bald verfügbar</i>						
S76AC	15	202	38	65	74		15	
S76AD	18	236	43	68	116		15	
S76AE	22	233	40	68	158		10	
S76AF	28	303	64	93	258		10	

Sprungbogen

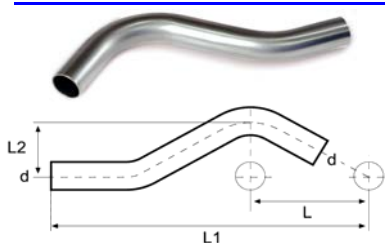

Art. Nr.	d	L1	L2	L	Gewicht in g	€	Mind. Menge	
S77AB	12	<i>bald verfügbar</i>						
S77AC	15	145	37	57	54		10	
S77AD	18	165	38	56	72		10	
S77AE	22	181	40	60	122		10	
S77AF	28	241	55	83	215		10	

ÜBERGANGSVERBINDUNG FÜR GENUTETE FITTING

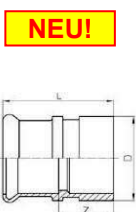

NEU!

Art. Nr.	d	L	Z	Gewicht in g	€	Mind. Menge
S96EF	28x33,7					
S96SG	35x42,4					
S96TH	42x48,3	<i>bald verfügbar</i>				
S96VJ	54x60,3					
S96KK	76,1x76,1	Verbindungsanschluß zwischen				
S96LL	88,9x88,9	genutetem Fittingsystem und Pressfittingen				
S96ZM	108x114,4					

Kugelhahn Volldurchgang

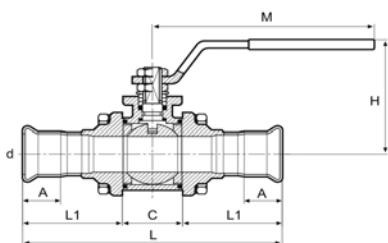

* Für ein Angebot setzen Sie sich bitte mit uns in Verbindung

Art. Nr.	d	L	L1	C	A	M	H	Gewicht in g	€	Mind. Menge
S58AC	15	118	48	22	20	105	57	534	*	15
S58AD	18	119,4	48	23,4	21	110	62	542	*	15
S58AE	22	133	51	31	21	110	67	775	*	15
S58AF	28	147,9	55	37,9	24	130	85	1.160	*	15
S58AG	35	177	65	47	27	130	85	1.780	*	10
S58AH	42	205	74	57	32	160	100	2.900	*	10
S58AJ	54	228	80	68	38	160	110	4.480	*	10
S58AK	76,1	316	115	86	55	235	130	7.350	*	5
S58AL	88,9	346	124	98	64	245	140	12.500	*	5
S58AM	108	432	153	126	78	330	170	22.750	*	5

Zweistück-Schraubventil

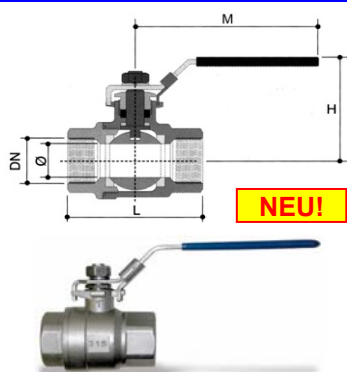

Art. Nr.	DN	L	H	M	Gewicht in g	€	Mind. Menge
S59AN	3/8"	49	48	100	534	*	15
S59AP	1/2"	55,0	52,0	100	542	*	15
S59AQ	3/4"	66	57	115	775	*	15
S59AR	1"	78,5	75,0	150	1.160	*	15
S59AS	1"1/4	90	80	150	1.780	*	10
S59AT	1"1/2	99	95	180	2.900	*	10
S59AV	2"	120	96	180	4.480	*	10
S59AX	2"1/2	147	125	245	7.350	*	5
S59AY	3"	172	135	245	12.500	*	5
S59AZ	4"	220	160	278	22.750	*	5

Kombimuffe mit Anschweissende

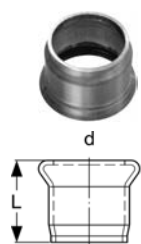

Unsere technische Abteilung gibt Auskunft für eine korrekte Anwendung

Art. Nr.	d	L	Gewicht in g	€	Mind. Menge
S17AB	12	<i>bald verfügbar</i>			
S17AC	15	25	17		200
S17AD	18	25	22		200
S17AE	22	27	30		200
S17AF	28	30	37		150
S17AG	35	34	51		150
S17AH	42	38	67		100
S17AJ	54	44	100		100
S17AK	76	68	290		50
S17AL	89	78	390		50
S17AM	108	94	595		50

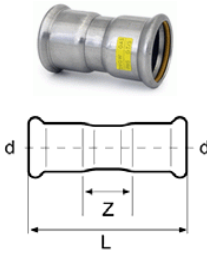
Muffe	Art. Nr.	d	L	Z	Gewicht in gr	€	Mind. Menge
	G10AC	15	52	10	39		100
	G10AD	18	52	10	44		100
	G10AE	22	59	13	62		100
	G10AF	28	61	13	78		100
	G10AG	35	72	18	109		60
	G10AH	42	79	15	147		30
	G10AJ	54	90	16	205		30
	G10AK	76,1	142	32	604		5
	G10AL	88,9	163	37	837		5
	G10AM	108	192	38	1.193		5

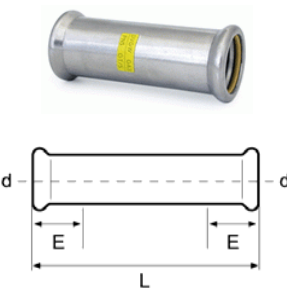
Schiebemuffe	Art. Nr.	d	L	E	Gewicht in gr	€	Mind. Menge
	G11AC	15	71	24	47		100
	G11AD	18	77	25	63		50
	G11AE	22	82	27	85		50
	G11AF	28	90	28	114		50
	G11AG	35	99	31	149		50
	G11AH	42	115	35	216		30
	G11AJ	54	139	40	316		20

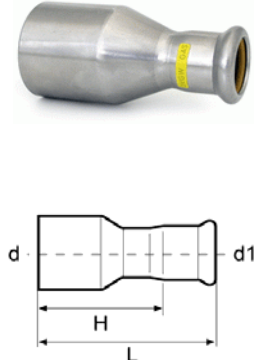
Absatznippel	Art. Nr.	d-d1	L	H	Gewicht in gr	€	Mind. Menge
	G12DC	18-15	55	34	40		100
	G12EC	22-15	60	39	45		100
	G12ED	22-18	57	36	47		100
	G12FC	28-15	72	51	56		80
	G12FD	28-18	77	56	61		80
	G12FE	28-22	67	44	65		100
	G12GE	35-22	83	60	98		80
	G12GF	35-28	73	49	112		80
	G12HF	42-28	98	74	140		30
	G12HG	42-35	79	52	120		30
	G12JF	54-28	99	75	193		20
	G12JG	54-35	128	101	237		20
	G12JH	54-42	97	65	191		20
	G12KH	76,1-42	151	119	425		5
	G12KJ	76,1-54	140	103	451		5
	G12LJ	88,9-54	156	119	586		5
	G12LK	88,9-76,1	156	101	653		5
	G12MJ	108-54	204	167	880		5
	G12MK	108-76,1	196	141	978		5
G12ML	108-88,9	190	127	992		5	

**Bogen 90°
2 Muffen**

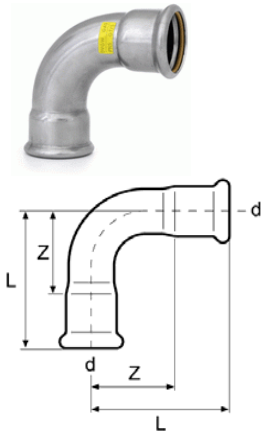

Art. Nr.	d	L	Z	Gewicht in gr	€	Mind. Menge
G20AC	15	48	27	57		100
G20AD	18	53	32	77		100
G20AE	22	60	37	97		100
G20AF	28	71	47	143		60
G20AG	35	87	60	198		60
G20AH	42	115	83	314		30
G20AJ	54	142	105	499		20
G20ZG	35	75	48	173		60
G20ZH	42	89	57	261		30
G20ZJ	54	107	70	391		20
G20ZK	76,1	150	95	977		5
G20ZL	88,9	174	111	1.325		5
G20ZM	108	215	138	2.091		5

**Einsteckbogen 90°
1 Muffe 90°**

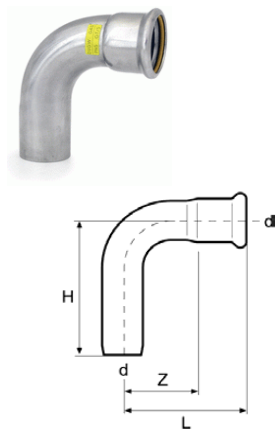

Art. Nr.	d	L	H	Z	Gewicht in gr	€	Mind. Menge
G21AC	15	48	56	27	58		100
G21AD	18	53	62	32	70		100
G21AE	22	60	68	37	98		100
G21AF	28	71	80	47	147		50
G21AG	35	87	93	60	200		50
G21AH	42	115	125	83	331		20
G21AJ	54	142	149	105	505		20
G21ZG	35	75	83	48	179		50
G21ZH	42	89	97	57	260		20
G21ZJ	54	107	116	70	400		20
G21ZK	76,1	150	165	95	982		5
G21ZL	88,9	174	190	111	1.317		5
G21ZM	108	215	238	138	2.068		5

**Bogen 45°
2 Muffen**

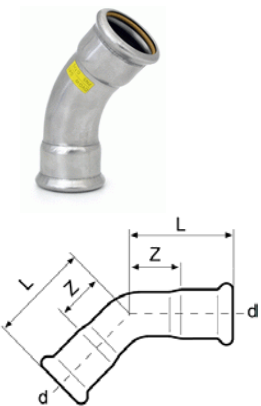

Art. Nr.	d	L	Z	Gewicht in gr	€	Mind. Menge
G22AC	15	37	16	49		100
G22AD	18	38	17	59		100
G22AE	22	44	21	81		100
G22AF	28	51	27	118		50
G22AG	35	59	32	161		50
G22AH	42	77	45	254		20
G22AJ	54	88	51	369		20
G22ZG	35	49	22	152		50
G22ZH	42	63	31	216		20
G22ZJ	54	75	38	323		20
G22ZK	76,1	98	43	773		5
G22ZL	88,9	112	49	991		5
G22ZM	108	138	61	1.600		5

Einsteckbogen 45°



R = 1,5 d

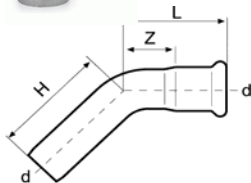

R = 1,2 d

Art. Nr.	d	L	Z	Gewicht in gr	€	Mind. Menge
G23AC	15	37	48	16	53	100
G23AD	18	38	45	17	59	100
G23AE	22	44	53	21	85	100
G23AF	28	51	60	27	117	50
G23AG	35	59	66	32	160	50
G23AH	42	77	80	45	237	20
G23AJ	54	88	97	51	366	20
<hr/>						
G23ZG	35	49	51	22	155	50
G23ZH	42	63	72	31	203	20
G23ZJ	54	75	83	38	310	20
G23ZK	76,1	98	117	43	767	5
G23ZL	88,9	112	131	49	998	5
G23ZM	108	138	154	61	1.510	5

Übergangsmuffe I.G.

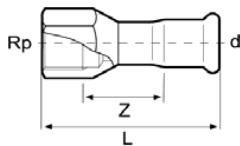

Art. Nr.	d - Rp	L	Z	Gewicht in gr	€	Mind. Menge
G80PC	15-Rp $\frac{1}{2}$	53	20	52		100
G80PD	18-Rp $\frac{1}{2}$	51	18	52		100
G80PE	22-Rp $\frac{1}{2}$	52	17	77		100
G80QE	22-Rp $\frac{3}{4}$	56	20	75		100
G80RE	22-Rp1	70	31	105		80
G80RF	28-Rp1	62	22	103		80
G80RG	35-Rp1	81	38	136		50
G80SG	35-Rp $\frac{1}{4}$	72	28	170		50
G80TH	42-Rp $\frac{1}{2}$	74	25	252		30
G80VJ	54-Rp2	106	52	328		20

Übergangsmuffe A.G.

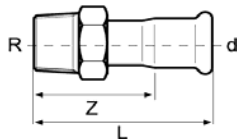

Art. Nr.	d - R	L	Z	Gewicht in gr	€	Mind. Menge
G81PC	15-R $\frac{1}{2}$	52	31	52		100
G81PD	18-R $\frac{1}{2}$	52	31	53		100
G81PE	22-R $\frac{1}{2}$	68	45	73		100
G81QE	22-R $\frac{3}{4}$	58	35	74		100
G81RE	22-R1	72	49	116		100
G81QF	28-R $\frac{3}{4}$	73	49	100		100
G81RF	28-R1	62	38	115		100
G81RG	35-R1	82	55	148		50
G81SG	35-R $\frac{1}{4}$	70	43	165		50
G81TG	35-R $\frac{1}{2}$	84	57	198		30
G81TH	42-R $\frac{1}{2}$	75	43	204		20
G81VJ	54-R2	87	50	368		20
G81XK	76,1-R 2 $\frac{1}{2}$	125	70	820		5
G81YL	88,9-R 3	138	75	1.158		5

Winkel I.G.

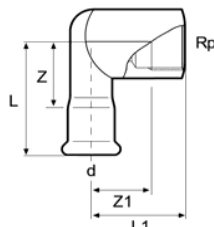

Part No.	d - Rp	L	L1	Z	Z1	Gewicht in gr	€	Mind. Menge
G30PC	15-Rp $\frac{1}{2}$	53	36	32	24	121		80
G30PD	18-Rp $\frac{1}{2}$	52	39	31	27	118		60
G30QE	22-Rp $\frac{3}{4}$	57	46	34	33	180		50
G30RF	28-Rp1	71	54	47	38	329		50
G30SG	35-Rp $\frac{1}{4}$	72	62	45	45	455		30

EDELSTAHL GAS AISI 316L

SCONTO:

Preis Liste 27

Juni 2011

www.eurotubieuropa.it

Winkel A.G.

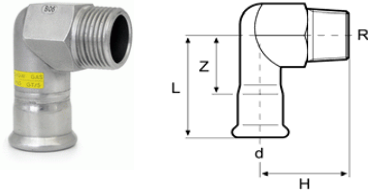

Art. Nr.	d - R	L	H	Z	Gewicht in gr	€	Mind. Menge
G31PC	15-R $\frac{1}{2}$	53	36	32	91		80
G31PD	18-R $\frac{1}{2}$	51	36	30	98		50
G31QE	22-R $\frac{3}{4}$	58	40	35	145		50
G31RF	28-R1	63	44	39	245		50
G31SG	35-R1 $\frac{1}{4}$	71	48	44	338		30

Deckenwinkel I.G.

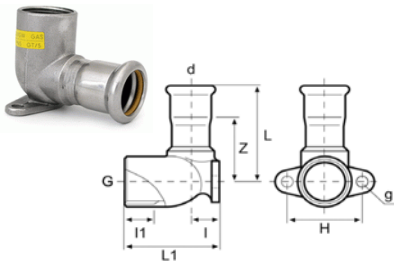

Art. Nr.	d - G (ISO 228)	L	L1	Z	I	I1	H	g	Gewicht in gr	€	Mind. Menge
G32PC	15-G $\frac{1}{2}$	46	43	25	12	12	34	5	104		80
G32PD	18-G $\frac{1}{2}$	47	44	26	13	12	34	6	100		60
G32QE	22-G $\frac{3}{4}$	52	51	29	16	13	40	6	147		60

Stopfen

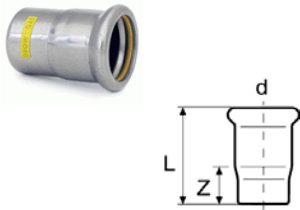

Art. Nr.	d	L	Z	Gewicht in gr	€	Mind. Menge
G50AC	15	37	16	27		100
G50AD	18	40	19	33		50
G50AE	22	41	18	44		50
G50AF	28	46	22	63		50
G50AG	35	51	24	81		50
G50AH	42	59	27	119		20
G50AJ	54	72	35	171		20

Übergangsflansch PN 16

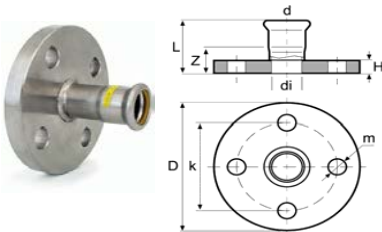

Art. Nr.	d	D	di	L	H	m	k	Z	Gewicht in gr	€	Mind. Menge
G52AE	22	105	21	59	12	14	75	39	783		20
G52AF	28	115	27	65	14	14	85	47	1.091		20
G52AG	35	140	32	70	15	18	100	52	1.717		20
G52AH	42	150	39	77	16	18	110	59	2.088		15
G52AJ	54	165	51	86	18	18	125	75	2.834		15
G52AK	76,1	185	72	126	18	18	145	71	3.546		5
G52AL	88,9	200	85	147	20	18	160	84	4.344		5
G52AM	108	220	104	167	20	18	180	90	5.251		5

T-Stück

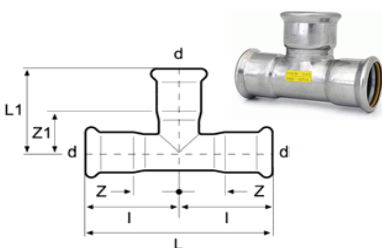

Art. Nr.	d	L	L1	Z	Z1	I	Gewicht in gr	€	Mind. Menge
G40AC	15	74	35	16	14	37	67		100
G40AD	18	80	35	19	14	40	84		100
G40AE	22	82	40	18	17	41	112		100
G40AF	28	92	45	22	21	46	149		80
G40AG	35	102	55	24	28	51	189		50
G40AH	42	118	61	27	29	59	275		20
G40AJ	54	142	72	34	35	71	382		20
G40AK	76,1	232	115	61	60	116	1.192		5
G40AL	88,9	262	127	68	64	131	1.617		5
G40AM	108	312	155	79	78	156	2.450		5

Red. T-Stück

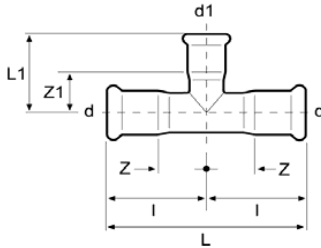

Art. Nr.	d - d1 - d	L	L1	Z	Z1	I	Gewicht in gr	€	Mind. Menge
G41CD	18-15-18	80	36	19	15	40	83		100
G41CE	22-15-22	82	39	18	18	41	98		100
G41DE	22-18-22	82	38	18	17	41	105		100
G41CF	28-15-28	92	42	22	21	46	130		80
G41DF	28-18-28	92	42	22	21	46	132		80
G41EF	28-22-28	92	45	22	22	46	140		80
G41CG	35-15-35	102	45	24	24	51	164		50
G41DG	35-18-35	102	45	24	24	51	164		50
G41EG	35-22-35	102	46	24	23	51	172		50
G41FG	35-28-35	102	48	24	24	51	175		50
G41EH	42-22-42	118	51	27	28	59	239		30
G41FH	42-28-42	118	53	27	29	59	240		30
G41GH	42-35-42	118	60	27	33	59	242		30
G41EJ	54-22-54	142	57	34	34	71	325		20
G41FJ	54-28-54	142	60	34	36	71	348		15
G41GJ	54-35-54	142	66	34	39	71	344		15
G41HJ	54-42-54	142	64	34	32	71	368		15
G41EK	76,1-22-76,1	232	68	61	45	116	942		5
G41FK	76,1-28-76,1	232	71	61	47	116	956		5
G41GK	76,1-35-76,1	232	75	61	48	116	968		5
G41HK	76,1-42-76,1	232	79	61	47	116	981		5
G41JK	76,1-54-76,1	232	80	61	43	116	1.067		5
G41EL	88,9-22-88,9	262	76	68	53	131	1.256		5
G41FL	88,9-28-88,9	262	76	68	52	131	1.244		5
G41GL	88,9-35-88,9	262	83	68	56	131	1.267		5
G41HL	88,9-42-88,9	262	85	68	53	131	1.271		5
G41JL	88,9-54-88,9	262	93	68	56	131	1.297		5
G41EM	108-22-108	312	85	79	62	156	1.919		5
G41FM	108-28-108	312	88	79	64	156	1.939		5
G41GM	108-35-108	312	94	79	67	156	1.955		5
G41HM	108-42-108	312	96	79	64	156	1.886		5
G41JM	108-54-108	312	102	79	65	156	1.967		5

T-Stück mit I.G. Abgang

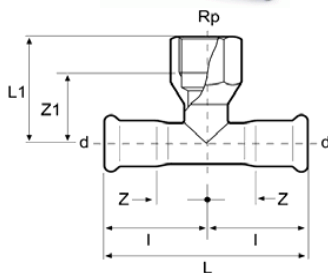

Art. Nr.	d - Rp	L	L1	Z	Z1	I	Gewicht in gr	€	Mind. Menge
G42PC	15-Rp $\frac{1}{2}$ -15	74	37	16	25	37	83		100
G42PD	18-Rp $\frac{1}{2}$ -18	80	39	19	27	40	95		80
G42QD	18-Rp $\frac{3}{4}$ -18	80	43	19	30	40	118		50
G42PE	22-Rp $\frac{1}{2}$ -22	82	41	18	29	41	117		100
G42QE	22-Rp $\frac{3}{4}$ -22	82	41	18	28	41	131		80
G42PF	28-Rp $\frac{1}{2}$ -28	92	44	22	32	46	144		80
G42QF	28-Rp $\frac{3}{4}$ -28	92	45	22	32	46	159		50
G42PG	35-Rp $\frac{1}{2}$ -35	102	48	24	36	51	178		50
G42QG	35-Rp $\frac{3}{4}$ -35	102	48	24	35	51	189		50
G42PH	42-Rp $\frac{1}{2}$ -42	118	46	27	34	59	240		20
G42PJ	54-Rp $\frac{1}{2}$ -54	142	55	34	43	71	362		15
G42QJ	54-Rp $\frac{3}{4}$ -54	142	58	34	45	71	364		15
G42VJ	54-Rp2-54	142	69	34	47	71	523		15
G42QK	76,1-Rp $\frac{3}{4}$ -76,1	232	68	61	55	116	1.009		5
G42VK	76,1-Rp2-76,1	232	81	61	59	116	1.194		5
G42QL	88,9-Rp $\frac{3}{4}$ -88,9	262	87	68	74	131	1.210		5
G42VL	88,9-Rp2-88,9	262	88	68	66	131	1.450		5
G42QM	108-Rp $\frac{3}{4}$ -108	312	86	79	73	156	1.956		5
G42VM	108-Rp2-108	312	98	79	76	156	2.118		5

**Anschlussverschraubung
Flachdichtung in HNBR
Messing-oder Inoxmutter**

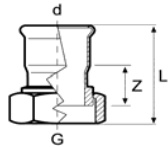

NEU!



Für die Preise mit
Edelstahlmutter wenden
Sie sich bitte an unsere
Vertriebssabt., unsere Teile-
Nr. G61

Art. Nr.	G - d (ISO 228)	Überwurf- mutter	L	Z	Gewicht in gr	€	Mind. Menge
G60QC	G $\frac{3}{4}$ -15	Messing	51	21	87		50
G60SC	G1 $\frac{1}{4}$ -15	Messing	53	21	175		15
G60QD	G $\frac{3}{4}$ -18	Messing	52	22	85		50
G60RE	G1-22	Messing	53	19	104		50
G60SF	G1 $\frac{1}{4}$ -28	Messing	54	20	159		50
G60TG	G1 $\frac{1}{2}$ -35	Messing	64	26	267		20
G60UH	G1 $\frac{3}{4}$ -42	Messing	69	24	325		20
G60WJ	G2 $\frac{3}{8}$ -54	Messing	78	27	476		20

**Anschlussverschraubung, konische
Nut, Dichtung in HNBR
Messing-oder Inoxmutter**

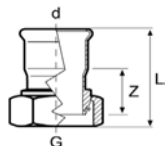

Art. Nr.	G - d (ISO 228)	Überwurf- mutter	L	Z	Gewicht in gr	€	Mind. Menge
G60WC	G $\frac{7}{8}$ -15	Messing	47	21	123		50
G60XE	G1 $\frac{1}{8}$ -22	Messing	51	26	207		50
G60YF	G1 $\frac{3}{8}$ -28	Messing	55	28	324		50

**Übergangverschraubung I.G.
Flachdichtung in HNBR
Messing-oder Inoxmutter**



NEU!

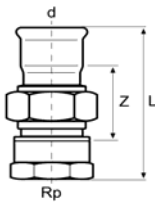

Art. Nr.	d - Rp	Überwurf- mutter	L	Z	Gewicht in gr	€	Mind. Menge
G62PC	15-Rp $\frac{1}{2}$	Messing	73	40	145		15
G62QC	15-Rp $\frac{3}{4}$	Messing	75	41	182		15
G62PD	18-Rp $\frac{1}{2}$		72	39	145		15
G62QD	18-Rp $\frac{3}{4}$	Messing	74	40	180		15
G62QE	22-Rp $\frac{3}{4}$	Messing	76	40	212		15
G62RE	22-Rp1	Messing	79	40	242		15
G62RF	28-Rp1	Messing	83	43	398		15
G62SG	35-Rp1 $\frac{1}{4}$	Messing	93	49	467		15
G62TH	42-Rp1 $\frac{1}{2}$	Messing	96	47	562		15
G62VJ	54-Rp2	Messing	113	54	973		15

Für die Preise mit Edelmutter wenden Sie
sich bitte an unsere Vertriebssabt., unsere Teile-
Nr. G63

**Übergangverschraubung A.G.
Flachdichtung in HNBR
Messing-oder Inoxmutter**



NEW!

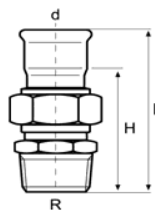

Art. Nr.	d - R	Überwurf- mutter	L	H	Gewicht in gr	€	min. lot
G64PC	15-R $\frac{1}{2}$	Messing	76	55	147		15
G64QC	15-R $\frac{3}{4}$	Messing	80	59	166		15
G64PD	18-R $\frac{1}{2}$	Messing	76	55	148		15
G64QD	18-R $\frac{3}{4}$	Messing	79	58	167		15
G64PE	22-R $\frac{1}{2}$	Messing	80	57	239		15
G64QE	22-R $\frac{3}{4}$	Messing	82	59	222		15
G64RE	22-R1	Messing	86	63	256		15
G64RF	28-R1	Messing	88	64	360		15
G64SG	35-R1 $\frac{1}{4}$	Messing	100	73	544		15
G64TH	42-R1 $\frac{1}{2}$	Messing	106	74	628		15
G64VJ	54-R2	Messing	122	85	1.008		15

Für die Preise mit Edelmutter wenden Sie
sich bitte an unsere Vertriebssabt., unsere Teile-
Nr. G65

Muffe

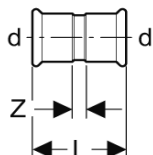

Art. Nr.	d	L	Z	Gewicht in g	€	VPE / Beutel	Mind. Menge
C10AB	12	42	6	30		20	200
C10AC	15	52	10	36		20	200
C10AD	18	52	10	45		20	200
C10AE	22	59	13	60		20	200
C10AF	28	61	13	77		20	200
C10AG	35	72	18	103		10	120
C10AH	42	79	15	142		8	60
C10AJ	54	90	16	202		6	60
C10AK	76,1	142	32	619		-	10
C10AL	88,9	163	37	817		-	10
C10AM	108	192	38	1.204		-	10

Schiebemuffe

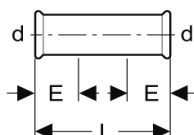

Art. Nr.	d	L	E	Gewicht in g	€	VPE / Beutel	Mind. Menge
C11AB	12	56	22	40		20	200
C11AC	15	75	24	51		20	200
C11AD	18	77	25	60		20	100
C11AE	22	86	27	81		20	100
C11AF	28	92	28	112		20	100
C11AG	35	99	31	136		10	100
C11AH	42	119	35	203		6	60
C11AJ	54	145	40	280		4	40
C11AK	76,1	230	60	875		-	10
C11AL	88,9	262	70	1.200		-	10
C11AM	108	304	80	1.705		-	10

Absatznippel

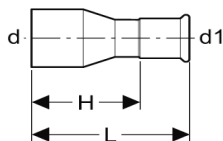

Art. Nr.	d - d1	L	H	Gewicht in g	€	VPE / Beutel	Mind. Menge
C12CB	15-12	51	33	26		20	200
C12DB	18-12	53	35	32		20	200
C12DC	18-15	55	34	36		20	200
C12EB	22-12	60	42	39		20	200
C12EC	22-15	60	39	42		20	200
C12ED	22-18	57	36	44		20	200
C12FB	28-12	75	57	55		20	160
C12FC	28-15	81	60	62		20	160
C12FD	28-18	84	63	68		20	160
C12FE	28-22	70	47	67		20	200
C12GC	35-15	84	63	84		10	60
C12GD	35-18	87	66	90		10	60
C12GE	35-22	76	53	95		10	160
C12GF	35-28	74	48	87		10	160
C12HD	42-18	98	77	180		6	30
C12HE	42-22	87	64	177		6	60
C12HF	42-28	100	76	128		6	60
C12HG	42-35	78	52	115		6	60
C12JD	54-18	108	87	190		4	30
C12JE	54-22	110	88	185		4	30
C12JF	54-28	100	76	185		4	40
C12JG	54-35	129	102	206		4	40
C12JH	54-42	108	76	189		4	40
C12KH	76,1-42	151	119	425		-	10
C12KJ	76,1-54	145	108	454		-	10
C12LJ	88,9-54	157	120	591		-	10
C12LK	88,9-76,1	157	105	660		-	10
C12MJ	108-54	204	167	880		-	10
C12MK	108-76,1	196	144	948		-	10
C12ML	108-88,9	192	133	962		-	10

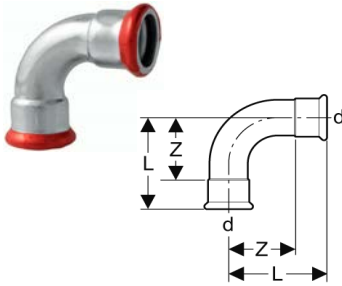
Bogen 90° R 1,2
2 Muffen

Art. Nr.	d	L	Z	Gewicht in g	€	VPE / Beutel	Mind. Menge
C20ZB	12	42	24	40		20	200
C20ZC	15	41	20	47		20	200
C20ZD	18	45	24	58		20	200
C20ZE	22	49	26	78		20	200
C20ZF	28	59	35	112		10	120
C20ZG	35	72	45	175		10	120
C20ZH	42	91	59	246		6	60
C20ZJ	54	110	73	395		4	40
C20ZK	76,1	150	95	977		-	10
C20ZL	88,9	174	111	1.324		-	10
C20ZM	108	215	138	1.991		-	10

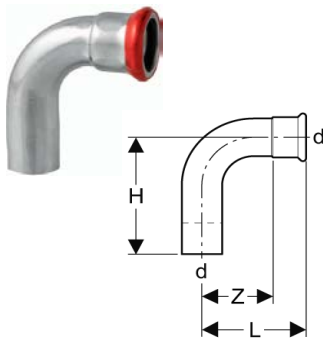
Einsteckbogen 90° R 1,2
1 Muffen

Art. Nr.	d	L	H	Z	Gewicht in g	€	VPE / Beutel	Mind. Menge
C21ZB	12	42	48	24	35		20	200
C21ZC	15	41	49	20	47		20	200
C21ZD	18	45	53	24	58		20	200
C21ZE	22	49	59	26	80		20	200
C21ZF	28	59	69	35	113		10	100
C21ZG	35	72	83	45	175		10	100
C21ZH	42	91	96	59	250		6	40
C21ZJ	54	110	116	73	392		4	40
C21ZK	76,1	150	166	95	991		-	10
C21ZL	88,9	174	190	111	1.329		-	10
C21ZM	108	215	230	138	1.988		-	10

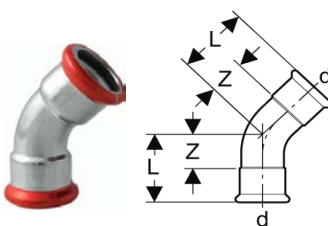
Bogen 45° R 1,2
2 Muffen

Art. Nr.	d	L	Z	Gewicht in g	€	VPE / Beutel	Mind. Menge
C22ZB	12	32	14	34		20	200
C22ZC	15	30	9	39		20	200
C22ZD	18	31	10	47		20	200
C22ZE	22	35	12	63		20	200
C22ZF	28	41	17	90		10	100
C22ZG	35	56	29	150		10	100
C22ZH	42	63	31	201		6	40
C22ZJ	54	75	38	304		4	40
C22ZK	76,1	98	43	800		-	10
C22ZL	88,9	113	50	1.034		-	10
C22ZM	108	138	61	1.550		-	10

Einsteckbogen 45° R 1,2

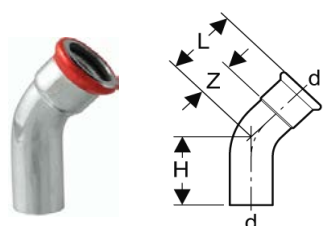

Art. Nr.	d	L	H	Z	Gewicht in g	€	VPE / Beutel	Mind. Menge
C23ZB	12	32	41	14	32		20	200
C23ZC	15	30	42	9	39		20	200
C23ZD	18	31	35	10	47		20	200
C23ZE	22	35	47	12	66		20	200
C23ZF	28	41	47	17	90		10	100
C23ZG	35	36	66	29	153		10	100
C23ZH	42	63	70	31	202		6	40
C23ZJ	54	75	82	38	316		4	40
C23ZK	76,1	98	119	43	800		-	10
C23ZL	88,9	113	130	50	1.054		-	10
C23ZM	108	138	160	61	1.580		-	10

Übergangsmuffe I.G.

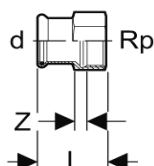

Art. Nr.	d - Rp	L	Z	Gewicht in g	€	VPE / Beutel	Mind. Menge
C80NB	12-Rp ^{3/8}	31	3	40		20	200
C80PB	12-Rp ^{1/2}	35	5	45		20	200
C80NC	15-Rp ^{3/8}	35	4	65		20	200
C80PC	15-Rp ^{1/2}	37	4	70		20	200
NEU C80QC	15-Rp ^{3/4}	38	4	71		20	200
C80PD	18-Rp ^{1/2}	37	4	57		20	200
C80QD	18-Rp ^{3/4}	38	4	75		20	200
C80PE	22-Rp ^{1/2}	37	3	87		20	200
C80QE	22-Rp ^{3/4}	40	4	80		20	200
C80RE	22-Rp1	43	4	114		20	160
C80PF	28-Rp ^{1/4}	45	9	191		20	160
C80QF	28-Rp ^{1/2}	43	6	139		20	160
NEU C80RG	35-Rp1	45	8	130		10	150
NEU C80SG	35-Rp1 ^{1/4}	73	25	300		10	150
NEU C80TH	42-Rp1 ^{1/2}	75	20	270		4	120
NEU C80VJ	54-Rp2	85	18	360		4	120

Übergangsmuffe A.G.

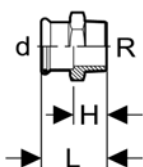

Art. Nr.	d - R	L	H	Gewicht in g	€	VPE / Beutel	Mind. Menge
C81NB	12-R ^{3/8}	36	18	38		20	150
C81PB	12-R ^{1/2}	40	22	45		20	150
C81NC	15-R ^{3/8}	43	22	41		20	200
C81PC	15-R ^{1/2}	43	22	55		20	200
C81QC	15-R ^{3/4}	44	23	87		20	100
C81PD	18-R ^{1/2}	44	23	65		20	200
C81QD	18-R ^{3/4}	45	24	79		20	100
C81PE	22-R ^{1/2}	44	21	75		20	200
C81QE	22-R ^{3/4}	45	22	95		20	200
C81RE	22-R1	47	24	154		20	200
C81QF	28-R ^{3/4}	47	23	101		20	200
C81RF	28-R1	49	25	107		20	160
C81SG	35-R1 ^{1/4}	54	27	169		10	100
C81TG	35-R1 ^{1/2}	54	27	172		10	100
C81TH	42-R1 ^{1/2}	58	26	226		6	40
C81VJ	54-R2	69	32	368		4	40
C81XK	76,1-R2 ^{1/2}	123	68	830		-	10
C81YL	88,9-R3	134	71	1.160		-	10
C81ZM	108-R4	156	78	2.005		-	10

Übergangsmuffe I.G.

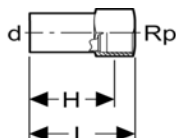

Art. Nr.	d - Rp	L	H	Gewicht in g	€	VPE / Beutel	Mind. Menge
C86NB	12-Rp ^{3/8}	54	44	52		20	100
C86PB	12-Rp ^{1/2}	58	46	60		20	100
C86NC	15-Rp ^{3/8}	74	64	57		20	100
C86PC	15-Rp ^{1/2}	61	49	60		20	100
C86PD	18-Rp ^{1/2}	61	49	62		20	100
C86QD	18-Rp ^{3/4}	64	51	91		20	100
C86PE	22-Rp ^{1/2}	61	49	65		20	100
C86QE	22-Rp ^{3/4}	65	52	93		10	100

Absatzmuffe A.G.

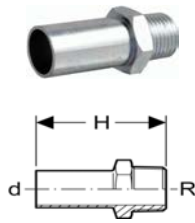

Art. Nr.	d - R	H	Gewicht in g	€	VPE / Beutel	Mind. Menge
C87NB	12-R $\frac{3}{8}$	50	51		20	100
C87PB	12-R $\frac{1}{2}$	55	63		20	100
C87PC	15-R $\frac{1}{2}$	57	70		20	100
C87PD	18-R $\frac{1}{2}$	57	74		20	100
C87QD	18-R $\frac{3}{4}$	59	103		20	100
C87PE	22-R $\frac{1}{2}$	57	77		20	100
C87QE	22-R $\frac{3}{4}$	59	105		10	100

Übergangsbogen 90° A.G.

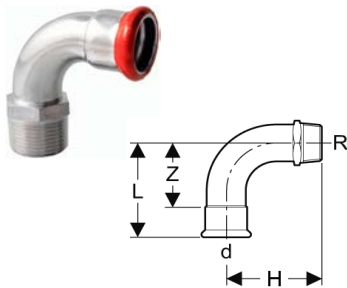

Art. Nr.	d - R	L	H	Z	Gewicht in g	€	VPE / Beutel	Mind. Menge
C83NB	12-R $\frac{3}{8}$	42	34	24	49		20	40
C83NC	15-R $\frac{3}{8}$	41	39	20	54		20	40
C83PC	15-R $\frac{1}{2}$	41	40	20	62		20	40
C83PD	18-R $\frac{1}{2}$	45	48	24	73		20	40
C83QE	22-R $\frac{3}{4}$	49	54	26	100		10	40
C83RF	28-R1	59	68	35	180		10	40
C83SG	35-R1 $\frac{1}{4}$	72	102	45	259		10	30
C83TH	42-R1 $\frac{1}{2}$	91	116	59	375		6	30
C83VJ	54-R2	110	142	73	670		4	30

Übergangsbogen 90° I.G.

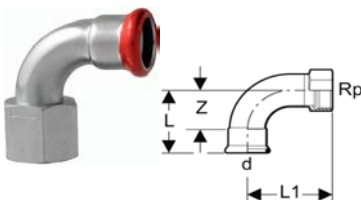

Art. Nr.	d - Rp	L	L1	Z	Gewicht in g	€	VPE / Beutel	Mind. Menge
C82NB	12-Rp $\frac{3}{8}$	42	41	24	55		20	40
C82NC	15-Rp $\frac{3}{8}$	41	44	20	60		20	40
C82PC	15-Rp $\frac{1}{2}$	41	44	20	74		20	40
C82PD	18-Rp $\frac{1}{2}$	45	51	24	84		20	40
C82QE	22-Rp $\frac{3}{4}$	49	56	26	119		10	40
C82PF	28-Rp $\frac{1}{2}$	59	64	35	97		10	40

Übergangswinkel 90° I. G.

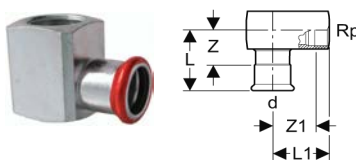

Art. Nr.	d - Rp	L	L1	Z	Z1	Gewicht in g	€	VPE / Beutel	Mind. Menge
C30PC	15-Rp $\frac{1}{2}$	36	27	15	15	173		20	160
C30PD	18-Rp $\frac{1}{2}$	36	27	15	15	169		20	120
C30PE	22-Rp $\frac{1}{2}$	42	40	19	28	254		10	100
C30QE	22-Rp $\frac{3}{4}$	42	30	19	17	285		10	100
C30PF	28-Rp $\frac{1}{2}$	47	43	23	31	436		10	100

Übergangswinkel 90° A.G.

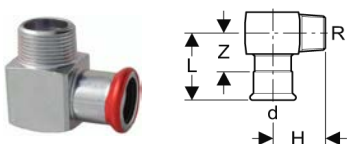

Art. Nr.	d - R	L	H	Z	Gewicht in g	€	VPE / Beutel	Mind. Menge
C31NB	12-R $\frac{3}{8}$	34	21	16	73		20	150
C31NC	15-R $\frac{3}{8}$	34	23	13	82		20	200
C31PC	15-R $\frac{1}{2}$	34	28	13	95		20	160
C31PD	18-R $\frac{1}{2}$	36	26	15	110		20	100
C31QD	18-R $\frac{3}{4}$	37	31	16	150		20	60
C31QE	22-R $\frac{3}{4}$	39	36	16	189		10	100

T-Stück

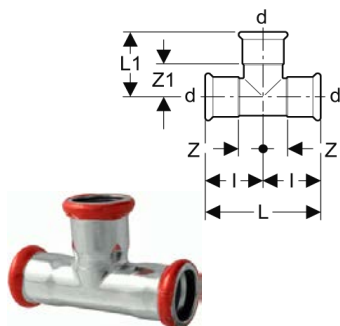

Art. Nr.	d	L	L1	Z	Z1	I	Gewicht in g	€	VPE / Beutel	Mind. Menge
C40AB	12	56	35	10	17	28	48		20	200
C40AC	15	74	36	16	15	37	67		20	200
C40AD	18	80	37	19	16	40	82		20	200
C40AE	22	82	43	18	20	41	109		20	200
C40AF	28	92	46	22	22	46	144		10	160
C40AG	35	102	55	24	28	51	189		10	100
C40AH	42	118	60	27	28	59	270		6	40
C40AJ	54	142	73	34	36	71	396		4	40
C40AK	76,1	232	121	61	66	116	1.150		-	10
C40AL	88,9	262	126	68	63	131	1.600		-	10
C40AM	108	312	152	79	75	156	2.319		-	10

Red. T-Stück

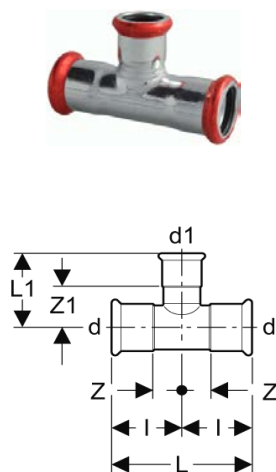

Art. Nr.	d - d1 - d	L	L1	Z	Z1	I	Gewicht in g	€	VPE / Beutel	Mind. Menge
C41BC	15-12-15	74	33	16	15	37	63		20	100
C41BD	18-12-18	80	34	19	16	40	74		20	100
C41CD	18-15-18	80	35	19	14	40	78		20	200
C41BE	22-12-22	82	36	18	18	41	94		20	100
C41CE	22-15-22	82	40	18	19	41	98		20	200
C41DE	22-18-22	82	40	18	19	41	100		20	200
C41CF	28-15-28	92	42	22	21	46	126		10	160
C41DF	28-18-28	92	43	22	22	46	128		10	160
C41EF	28-22-28	92	46	22	23	46	135		10	160
C41CG	35-15-35	102	45	24	24	51	159		10	100
C41DG	35-18-35	102	45	24	24	51	160		10	100
C41EG	35-22-35	102	48	24	25	51	169		10	100
C41FG	35-28-35	102	50	24	25	51	178		10	100
C41CH	42-15-42	118	52	27	31	59	224		6	60
C41DH	42-18-42	118	52	27	31	59	228		6	60
C41EH	42-22-42	118	54	27	31	59	233		6	60
C41FH	42-28-42	118	53	27	29	59	239		6	60
C41GH	42-35-42	118	57	27	30	59	254		6	60
C41CJ	54-15-54	142	54	34	33	71	349		4	40
C41DJ	54-18-54	142	54	34	33	71	354		4	40
C41EJ	54-22-54	142	56	34	33	71	360		4	40
C41FJ	54-28-54	142	59	34	35	71	339		4	30
C41GJ	54-35-54	142	64	34	37	71	350		4	30
C41HJ	54-42-54	142	68	34	36	71	378		4	50
C41EK	76,1-22-76,1	232	68	61	45	116	942		-	10
C41FK	76,1-28-76,1	232	71	61	47	116	956		-	10
C41GK	76,1-35-76,1	232	75	61	48	116	968		-	10
C41HK	76,1-42-76,1	232	79	61	47	116	981		-	10
C41JK	76,1-54-76,1	232	80	61	43	116	1.050		-	10
C41EL	88,9-22-88,9	262	76	68	53	131	1.256		-	10
C41FL	88,9-28-88,9	262	75,5	68	51,5	131	1.244		-	10
C41GL	88,9-35-88,9	262	83	68	56,5	131	1.267		-	10
C41HL	88,9-42-88,9	262	85	68	53	131	1.271		-	10
C41JL	88,9-54-88,9	262	92,5	68	55,5	131	1.297		-	10
C41KL	88,9-76,1-88,9	262	128	68	73	131	1.500		-	10
C41EM	108-22-108	312	85	79	62	156	1.838		-	10
C41FM	108-28-108	312	87,5	79	63,5	156	1.939		-	10
C41GM	108-35-108	312	93,5	79	66	156	1.955		-	10
C41HM	108-42-108	312	96	79	64	156	1.886		-	10
C41JM	108-54-108	312	102	79	65	156	1.967		-	10
C41KM	108-76,1-108	312	125	79	70,2	156	2.147		-	10
C41LM	108-88,9-108	312	135	79	72	156	2.184		-	10

T-Stück mit I.G. Abgang

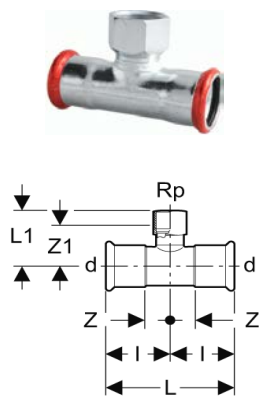

Art. Nr.	d - Rp	L	L1	Z	Z1	I	Gewicht in g	€	VPE / Beutel	Mind. Menge
C42NB	12-Rp $\frac{3}{8}$ -12	56	33	10	23	28	68		20	100
C42PB	12-Rp $\frac{1}{2}$ -12	56	36	10	23	28	75		20	100
C42PC	15-Rp $\frac{1}{2}$ -15	74	38	16	23	37	82		20	200
C42PD	18-Rp $\frac{1}{2}$ -18	80	39	20	24	40	95		20	160
C42PE	22-Rp $\frac{1}{2}$ -22	82	42	18	30	41	113		20	200
C42QE	22-Rp $\frac{3}{4}$ -22	82	43	18	30	41	120		20	100
C42PF	28-Rp $\frac{1}{2}$ -28	92	44	22	32	46	140		10	160
C42QF	28-Rp $\frac{3}{4}$ -28	92	45	22	32	46	159		10	100
C42PG	35-Rp $\frac{1}{2}$ -35	102	48	24	36	51	176		10	100
C42QG	35-Rp $\frac{3}{4}$ -35	102	48	24	35	51	191		10	100
C42PH	42-Rp $\frac{1}{2}$ -42	118	46	27	34	59	250		6	40
C42QH	42-Rp $\frac{3}{4}$ -42	118	51	27	38	59	255		6	40
C42PJ	54-Rp $\frac{1}{2}$ -54	142	58	34	46	74	333		4	30
C42QJ	54-Rp $\frac{3}{4}$ -54	142	59	34	46	74	350		4	30
C42QK	76,1-Rp $\frac{3}{4}$ -76,1	232	69	61	56	116	950		-	10
C42QL	88,9-Rp $\frac{3}{4}$ -88,9	262	76	68	63	131	1.240		-	10
C42QM	108-Rp $\frac{3}{4}$ -108	312	86	79	73	156	1.830		-	10

T-Stück mit vergr. Abgang

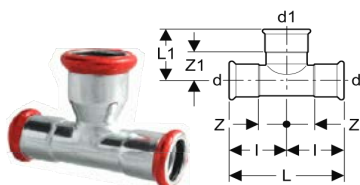

Art. Nr.	d - d1 - d	L	L1	Z	Z1	I	Gewicht in g	€	VPE / Beutel	Mind. Menge
C44CB	12-15-12	56	38	10	17	28	52		20	100
C44DC	15-18-15	74	36	16	15	37	71		20	100
C44EC	15-22-15	74	42	16	19	37	84		20	100
C44ED	18-22-18	80	45	19	22	40	97		20	100
C44FE	22-28-22	82	45	18	21	41	123		20	100

Kreuzstück 90°

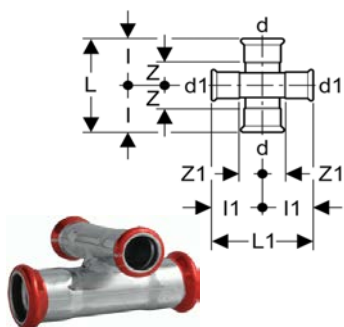

Art. Nr.	d - d1	L	L1	Z	Z1	I	I1	Gewicht in g	€	VPE / Beutel	Mind. Menge
C45AC	15-15	74	74	16	16	37	37	100		10	100
C45CD	18-15	80	74	19	16	40	37	110		10	100
C45CE	22-15	82	74	18	16	41	37	130		10	100
C45DE	22-18	82	80	18	19	41	40	140		10	100
C45CF	28-15	92	74	22	16	46	37	156		10	50
C45DF	28-18	92	80	22	19	46	40	166		10	50
C45EF	28-22	92	82	22	18	46	41	186		10	50
C45EG	35-22	102	82	24	18	51	41	218		10	50
C45EH	42-22	118	82	27	18	59	41	280		6	40
C45EJ	54-22	142	82	34	18	71	41	376		4	30

TAPPO

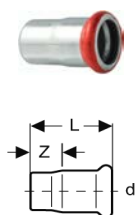

Art. Nr.	d	L	Z	Gewicht in g	€	VPE / Beutel	Mind. Menge
C50AB	12	30	12	20		20	100
C50AC	15	38	17	27		20	100
C50AD	18	41	20	35		10	100
C50AE	22	42	19	45		10	100
C50AF	28	46	22	62		10	100
C50AG	35	51	24	79		10	100
C50AH	42	59	27	123		6	40
C50AJ	54	73	36	179		4	40
C50AK	76,1	95	40	361		-	10
C50AL	88,9	115	52	495		-	10
C50AM	108	130	53	707		-	10

Stopfen

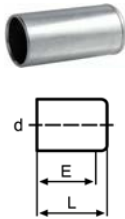

Art. Nr.	d	L	E	Gewicht in g	€	VPE / Beutel	Mind. Menge
C51AB	12	36	30	18		20	100
C51AC	15	42	33	25		20	100
C51AD	18	40	33	30		10	100
C51AE	22	43	34	41		10	100
C51AF	28	47	36	57		10	100
C51AG	35	49	40	76		10	100
C51AH	42	55	44	105		6	40
C51AJ	54	65	49	157		4	40
C51AK	76,1	87	74	350		-	10
C51AL	88,9	92	78	495		-	10
C51AM	108	107	92	702		-	10

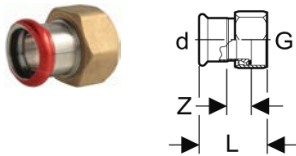
Anschlussverschraubung
mit Flachdichtung EPDM
Messingmutter

Art. Nr.	G - d (ISO 228)	L	Z	Gewicht in g	€	VPE / Beutel	Mind. Menge
C60QC	G $\frac{3}{4}$ -15	37	11	69		10	100
C60QD	G $\frac{3}{4}$ -18	39	11	70		10	100
C60RE	G1-22	40	11	84		10	100
C60SF	G1 $\frac{1}{4}$ -28	44	13	156		10	100
C60TG	G1 $\frac{1}{2}$ -35	48	13	194		8	40
C60UH	G1 $\frac{3}{4}$ -42	52	13	234		4	40
C60WJ	G2 $\frac{1}{2}$ -54	58	15	405		4	40

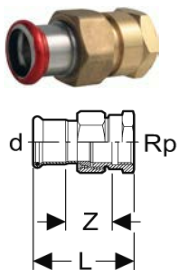
Übergangverschraubung I.G.
Flachdichtung EPDM
Messingmutter

Art. Nr.	d - Rp	L	Z	Gewicht in g	€	VPE / Beutel	Mind. Menge
C62PC	15-Rp $\frac{1}{2}$	59	26	188		10	30
C62QC	15-Rp $\frac{3}{4}$	61	26	157		10	30
C62PD	18-Rp $\frac{1}{2}$	59	26	190		10	30
C62QD	18-Rp $\frac{3}{4}$	61	26	158		10	30
C62QE	22-Rp $\frac{3}{4}$	63	27	184		10	30
C62RE	22-Rp1	66	28	212		10	30
C62RF	28-Rp1	71	31	388		10	30
C62SG	35-Rp1 $\frac{1}{4}$	77	32	429		6	30
C62TH	42-Rp1 $\frac{1}{2}$	82	33	509		6	30
C62VJ	54-Rp2	95	37	872		6	30

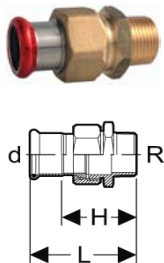
Übergangverschraubung A.G.
Flachdichtung EPDM
Messingmutter

Art. Nr.	d - R	L	H	Gewicht in g	€	VPE / Beutel	Mind. Menge
C64PC	15-R $\frac{1}{2}$	61	40	136		10	30
C64QC	15-R $\frac{3}{4}$	63	42	124		10	30
C64PD	18-R $\frac{1}{2}$	64	43	137		10	30
C64QD	18-R $\frac{3}{4}$	66	45	125		10	30
C64PE	22-R $\frac{1}{2}$	67	44	210		10	30
C64QE	22-R $\frac{3}{4}$	68	45	195		10	30
C64RE	22-R1	73	50	227		10	30
C64RF	28-R1	75	51	384		10	30
C64SG	35-R1 $\frac{1}{4}$	80	53	462		6	30
C64TH	42-R1 $\frac{1}{2}$	85	53	560		6	30
C64VJ	54-R2	97	60	863		6	30

Übergangverschraubung für
genutete Fittings

NEU!

Art. Nr.	d	L	Z	Gewicht in g	€	VPE / Beutel	Mind. Menge
C96EF	28x33,7						
C96SG	35x42,4						
C96TH	42x48,3						
C96VJ	54x60,3						
C96KK	76,1x76,1						
C96LL	88,9x88,9						
C96ZM	108x114,4						

zwischen
genutetem Fittingssystem und Pressfittingen

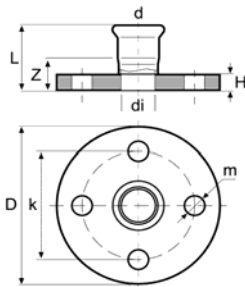
Übergangsflansch
PN 6 und PN 10/16

Art. Nr.	d	D	di	L	H	m	k	Z	Gewicht in g	€	VPE / Beutel	Mind. Menge
PN 10/16												
NEU C52AE	22	105	21	63	16	14	75	40	661		-	30
NEU C52AF	28	115	27	67	16	14	85	43	814		-	30
NEU C52AG	35	140	32	72	18	18	100	45	1.314		-	20
NEU C52AH	42	150	41,8	80	18	18	110	48	1.523		-	20
NEU C52AJ	54	165	54	96	18	18	125	59	1.721		-	20
C52AK	76,1	185	72	134	18	18	145	79	3.593		-	10
C52AL	88,9	200	85	141	20	18	160	78	4.615		-	10
C52AM	108	220	104	166	20	18	180	89	5.135		-	10

Durchmesser 88,9 und 108 (PN 10/16) mit 8 Befestigungslöcher

PN 6

NEU C53AE	22	90	21	61	14	11	65	38	1.009		-	30
NEU C53AF	28	100	27	65	14	11	75	41	1.212		-	30
NEU C53AG	35	120	32	70	16	14	90	43	1.991		-	20
NEU C53AH	42	130	39	77	16	14	100	45	2.291		-	20
NEU C53AJ	54	140	54	96	16	14	110	59	2.709		-	20
C53AK	76,1	160	72	130	14	14	130	75	2.144		-	10
C53AL	88,9	190	85	137	16	18	150	74	3.306		-	10
C53AM	108	210	104	162	16	18	170	85	4.003		-	10

Kombirohr mit Anschweissende*

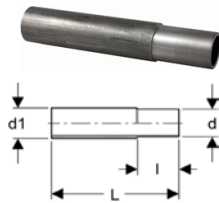

* nicht verzinkt

Art. Nr.	d-d1	L	l	Gewicht in g	€	VPE / Beutel	Mind. Menge
C13AB	12-17,2	120	26	70		20	200
C13AC	15-17,2	120	30	77		20	200
C13AD	18-21,3	120	30	92		20	200
C13AE	22-26,9	120	34	131		20	200
C13AF	28-33,7	120	34	210		20	200
C13AG	35-42,4	120	40	255		10	150
C13AH	42-48,3	120	45	307		10	100
C13AJ	54-60,3	120	50	375		5	100
C13AK	76,1-76,1	120	70	500		-	100
C13AL	88,9-88,9	120	75	659		-	100
C13AM	108-114,3	120	90	880		-	100

Überbogen

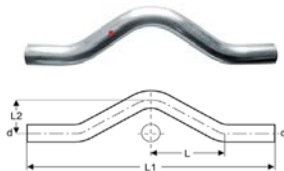

Art. Nr.	d	L1	L2	L	Gewicht in g	€	VPE / Beutel	Mind. Menge
C76AB	12	200	35	55	90		10	30
C76AC	15	202	37	64	110		10	30
C76AD	18	237	42	66	155		10	30
C76AE	22	233	42	58	159		10	20
C76AF	28	301	50	102	335		10	20

Sprungbogen



Art. Nr.	d	L1	L2	L	Gewicht in g	€	VPE / Beutel	Mind. Menge
C77AB	12	154	35	55	60		10	20
C77AC	15	145	37	57	80		10	20
C77AD	18	157	40	60	106		10	20
C77AE	22	175	52	65	147		10	20
C77AF	28	226	65	74	249		10	20

Passbogen 90°

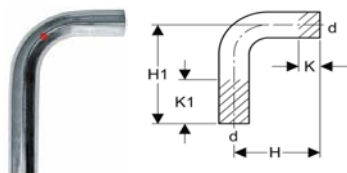

Art. Nr.	d	H1	H	K	K1	Gewicht in g	€	VPE / Beutel	Mind. Menge
C70AB	12	120	70	17	67	72		20	80
C70AC	15	120	70	22	72	88		20	80
C70AD	18	120	70	17	67	103		20	80
C70AE	22	120	70	9	59	132		10	40
C70AF	28	125	97	7	47	190		10	40
C70AG	35	201	121	62	62	359		8	20
C70AH	42	254	160	90	90	553		6	20
C70AJ	54	302	202	45	45	877		4	20
C70AK	76,1	250	250	62	60	1.752		-	10
C70AL	88,9	291	291	90	90	2.532		-	10
C70AM	108	364	364	45	45	3.604		-	10

Kombimuffe mit Anschweissende*

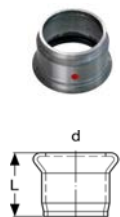

* nicht verzinkt

Unsere technische Abteilung gibt Auskunft
für eine korrekte Anwendung

Art. Nr.	d	L	Gewicht in g	€	VPE / Beutel	Mind. Menge
C17AB	12	23	12		-	400
C17AC	15	25	17		-	400
C17AD	18	25	21		-	400
C17AE	22	27	29		-	400
C17AF	28	30	36		-	300
C17AG	35	34	50		-	300
C17AH	42	38	65		-	200
C17AJ	54	44	97		-	200
C17AK	76,1	68	282		-	100
C17AL	88,9	78	375		-	100
C17AM	108	94	578		-	100

Kreuzungs-T-Stück Einfach

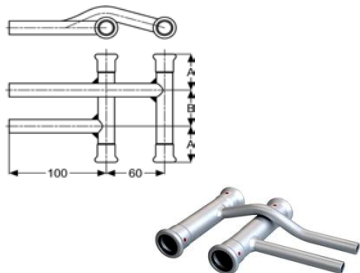

Art. Nr.	d1-d2	A	B	Gewicht in g	€	Mind. Menge
C91CC	15-15	40	40	250	*	20
C91BD	18-12	40	40	270	*	20
C91CD	18-15	40	40	280	*	20
C91BE	22-12	40	40	300	*	20
C91CE	22-15	40	40	320	*	20
C91BF	28-12	40	40	430	*	20
C91CF	28-15	40	40	450	*	20

* Für ein Angebot setzen Sie sich bitte mit uns in Verbindung

Kreuzungs-T-Stück Doppelt

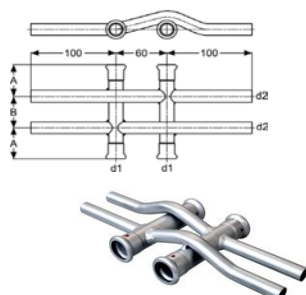

Art. Nr.	d1-d2	A	B	Gewicht in g	€	Mind. Menge
C90BB	12-12	30	40	305	*	20
C90BC	15-12	40	40	330	*	20
C90CC	15-15	40	40	355	*	20
C90BD	18-12	40	40	370	*	20
C90CD	18-15	40	40	380	*	20
C90CE	22-15	40	40	420	*	20
C90BF	28-12	40	40	530	*	20
C90CF	28-15	40	40	560	*	20
C90CG	35-15	40	40	660	*	20

* Für ein Angebot setzen Sie sich bitte mit uns in Verbindung

**Dichtring EPDM (schwarz)
für Trinkwasser**

STANDARD für Edelstahl und C-Stahl

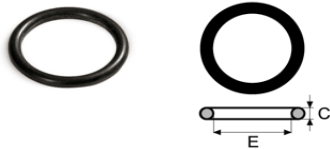

Art. Nr.	Abm.	E	C	Gewicht in g	€	Mind. Menge
000719	12	12	2,4	0,3		150
000720	15	15	2,6	0,3		150
000721	18	18	2,6	0,4		150
000722	22	22	3,2	0,7		150
000723	28	28	3,1	0,8		150
000724	35	35	3,1	1,0		100
000725	42	42	4,1	2,2		100
000726	54	54	4,1	2,8		100
000727	76,1	76,8	8	11,5		50
000728	88,9	89,3	8,2	17,5		50
000729	108	108,6	11	33,8		50

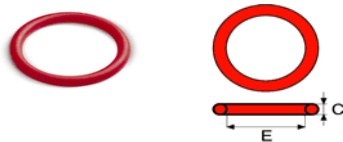
**Dichtring FPM Farbe (rot)
für Mineralöle **** Bitte wenden Sie sich an uns vor Absendung
der Bestellungen

Art. Nr.	Abm.	E	C	Gewicht in g	€	Mind. Menge
007496	12	12	2,4	0,3		100
007243	15	15	2,6	0,3		100
007244	18	18	2,6	0,4		100
007245	22	22	3,2	0,7		100
007246	28	28	3,1	0,8		100
007247	35	35	3,1	1,0		50
007248	42	42	4,1	2,2		50
007249	54	54	4,1	2,8		50
007250	76,1	76,8	8	11,5		20
007251	88,9	89,3	8,2	17,5		20
007252	108	108,6	11	33,8		20

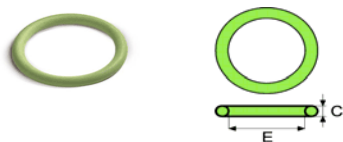
**Dichtring FPM Farbe (grün) für Öle,
Kohlenwasserstoff bis zum 170° C **** Bitte wenden Sie sich an uns vor Absendung
der Bestellungen

Art. Nr.	Abm.	E	C	Gewicht in g	€	Mind. Menge
002485	12	12	2,4	0,3		100
002849	15	15	2,6	0,3		100
002850	18	18	2,6	0,4		100
002851	22	22	3,2	0,7		100
002852	28	28	3,1	0,8		100
002853	35	35	3,1	1,0		50
002854	42	42	4,1	2,2		50
002855	54	54	4,1	2,8		50
002983	76,1	76,8	8	11,5		20
002984	88,9	89,3	8,2	17,5		20
002985	108	108,6	11	33,8		20

**Dichtring HNBR (Gelb)
für Gas**

STANDARD für Edelstahl Gas

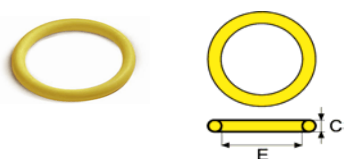

Art. Nr.	Abm.	E	C	Gewicht in g	€	Mind. Menge
002579	15	15	2,6	0,3		150
002580	18	18	2,6	0,4		150
002581	22	22	3,2	0,7		150
002582	28	28	3,1	0,8		150
002583	35	35	3,1	1,0		100
002584	42	42	4,1	2,2		100
002585	54	54	4,1	2,8		100
003266	76,1	76,8	8	11,5		50
003267	88,9	89,3	8,2	17,5		50
003268	108	108,6	11	33,8		50