

# BLITZ SUPER B4

- ▶ 100% MADE IN ITALY
- ▶ The closed front section gives a classic and elegant style to the radiator;
- ▶ Ideal for low-temperature heating systems;
- ▶ Excellent weight/power ratio, which facilitates transport, handling and installation;
- ▶ Unalterable over time thanks to its double coating: anaphoresis + powder coating
- ▶ High technological content: 3 international patents
- ▶ Openings at the rear of the radiator to increase convective heat exchange
- ▶ Modular: perfect for any space
- ▶ Maximum working pressure: 16 bar
- ▶ Pressure test (undergone by 100% of manufactured products): 24 bar
- ▶ Bursting pressure: 60 bar
- ▶ Greater heat exchange, low thermal inertia = outstanding performances, low power consumption.
- ▶ 10-years warranty.

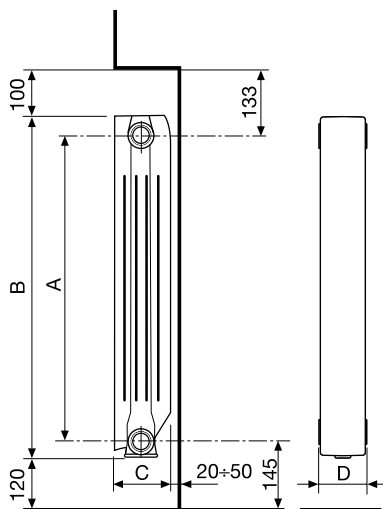

**STANDARD SUPPLY:** Available from 3 to 10 sections for centre distance 800 – from 3 to 12 sections for centre distance 700 - from 3 to 14 sections for centre distance 350-500-600.

**COLOUR:** Ral 9010 White



Fondital guarantees **BLITZ SUPER B4** for 10 years from the date of installation against all production defects providing the heating system is conform to the regulations, in compliance with the standards in force and provided the instructions on installation, use and correct maintenance supplied with the product have been observed.



Model	Code	Depth	Height	Centre distance	Length	Connection diameters	Water capacity	Heat output ΔT 50 K	Heat output ΔT 30 K	Exponent	Coeff.
		(C) mm	(B) mm	(A) mm	(D) mm	inches	litres/sect.	W/el.	W/el.	n	K <sub>m</sub>
350/100	V693014	97	407	350	80	G1	0,24	<b>92,4</b>	<b>48,0</b>	1,2818	0,6139
500/100	V693034	97	557	500	80	G1	0,27	<b>124,0</b>	<b>63,7</b>	1,3027	0,7587
600/100	V693044	97	657	600	80	G1	0,29	<b>143,5</b>	<b>73,8</b>	1,3015	0,8822
700/100	V693054	97	757	700	80	G1	0,35	<b>162,5</b>	<b>82,6</b>	1,3238	0,9155
800/100	V693064	97	857	800	80	G1	0,38	<b>178,2</b>	<b>90,3</b>	1,3301	0,9896

**Maximum working pressure: 1600 kPa (16 bar)**

Characteristic equation of the model  $\Phi = K_m \Delta T^n$ .

The thermal efficiency values shown comply with the European Standard EN 442-1:2014 and are certified by the MRT Lab of the Milan Polytechnic, notified body no. 1695.







# ACCESSORIES

(to be ordered separately)

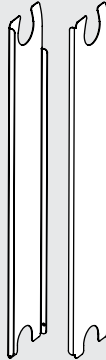

## ► SUPER B4

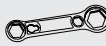
	Article	Code	Description
	A 1/1	520201 RH	1"G automatic air-purging valve, chromed (always to be installed with the vent in upward position)
		520202 LH	
	A 2/1	510011	1"G joining nipple
	A 4/1	525014 RH	1"G zinc-plated, paint-coated plug
		525114 LH	
	A 6/1	526014 RH	Reducer 3/8 white
		526214 RH	Reducer 1/2 white
		526414 RH	Reducer 3/4 white
		526114 LH	Reducer 3/8 white
		526314 LH	Reducer 1/2 white
		526514 LH	Reducer 3/4 white
	A 8/1	525214 RH	Valve plug 1/4 white
		525414 RH	Valve plug 1/8 white
		525314 LH	Valve plug 1/4 white
		525514 LH	Valve plug 1/8 white
	A 10/1	530105	Nipple gasket (asbestos-free)
	A 11/1	530108	Gasket for plugs (asbestos-free)
	A 13	540024	Touch-up spray paint (white RAL 9010) cc 400
	A 16	550020	Bracket to be embedded in the wall mm 175
	A 18	550035 RH	Bracket to be screwed on to the wall
		550036 LH	

	Article	Code	Description
	-	550360	Side covers kit, 350 mm
	-	550361	Side covers kit, 500 mm
	-	550362	Side covers kit, 600 mm
	-	550363	Side covers kit, 700 mm
	-	550364	Side covers kit, 800 mm
		5200521	Installation kit with two brackets, centre distance 350 mm
		5200522	Installation kit with two brackets, centre distance 500 mm
		5200523	Installation kit with two brackets, centre distance 600 mm
		5200524	Installation kit with two brackets, centre distance 700 mm
		5200525	Installation kit with two brackets, centre distance 800 mm
	A 20	550037	Installation kit with two adjustable, coated brackets
	A 26/1	550090	Nipple wrench 1"G
	A 40/2	560257	Plastic key
	A 80	550103	Mounting kit for radiators each containing: - 2 zinc-plated, paint-coated reducers 1/2"G, Rh - 2 zinc-plated, paint-coated reducers 1/2"G, Lh - 4 retaining gaskets - 1 manual air-purging valve 1/2"G with gasket - 1 (1/2"G) plug with gasket
	A 81	550104	Mounting kit for radiators each containing: - 2 zinc-plated, paint-coated reducers 1/2"G, Rh - 2 zinc-plated, paint-coated reducers 1/2"G, Lh - 4 retaining gaskets - 1 manual air-purging valve 1/2"G with gasket - 1 (1/2"G) plug with gasket - 3 brackets to be screwed on to the wall