

**Dear clients,**

We thank you for the purchase of one of our products and we hope it will be of your entire satisfaction.

We recommend to carefully read the manual, as they contain important indications regarding safety instructions on the use and maintenance of the radiator.

We also advise you to keep the instructions and the invoice carefully so that you can consult them if necessary.

**THE PACKAGING INCLUDES:**

A dry inertia aluminium radiator with digital programmable thermostat, a mounting bracket, an instructions manual.

**PRESENTATION**

The radiator consists of a EN AB 46100 aluminium alloy body. The inner heating element is an electric resistance embedded in a ceramic body.

A safety limiter limits the maximum temperature that the radiator can reach even in case of failure.

The radiator can be programmed on a daily and weekly basis.

**NOTE: all radiators are provided with an identification label to ensure traceability. This label certifies compliance with the applicable EU directives and electrical standards.**

The installation must be carried out in accordance with the standards and instructions in this manual.

**SUMMARY**

1. WARNINGS.....	Page. 17
2. FEATURES.....	Page. 18
3. ELECTRICAL CONNECTIONS.....	Page. 18
3.1. SPECIFICATIONS FOR INSTALLATION IN THE BATHROOM.....	Page. 19
4. INSTALLATION OF THE DEVICE.....	Page. 19
4.1. WALL MOUNTING OF THE RADIATOR.....	Page. 20
5. USE.....	Page. 22
6. RADIATOR CLEANING.....	Page. 27
7. MALFUNCTIONS.....	Page. 28
8. WARRANTY.....	Page. 28
9. ENVIRONMENT.....	Page. 29
10. DECLARATION OF CONFORMITY.....	Page. 29
11. INFORMATION REQUIREMENTS FOR ELECTRIC LOCAL SPACE HEATERS.....	Page. 31
12. RANGE AND SIZES.....	Page. 31

## 1. WARNINGS



REMINDERS: You will find a tag on the radiator with the following symbol. The meaning of this symbol is as follows:

In order to avoid any possible overheating, **DO NOT COVER THE RADIATOR.**

Under no circumstances should you:

- cover the radiator, even partially;
- place the radiator close to or in direct contact with curtains, furniture, etc.;

Under no circumstances should you install the radiator:

- in a niche;
- at less than 10 cm of the room's angles;
- under an electrical socket;
- on a shelf.



The radiator must be installed to the wall with the provided mounting bracket.

Any work on the appliance must be carried out by authorised professionals.

If the power cable is damaged, it must be replaced by the manufacturer, its service department or similarly qualified persons to avoid danger.

Children under 3 years of age should be kept away if they are not continuously supervised.

Children between the ages of 3 and 8 can only switch on/off the device, provided the device has been placed or installed according to the manual and that said children are supervised or have been instructed on the usage of the device, taking all precautions needed. It is important to ensure that they understand the dangers involved. Children between the ages of 3 and 8 cannot plug, adjust or clean the device or service the device.

**WARNING - Parts of this product can become very hot and burn. Particular attention should be paid if children and vulnerable people are present.**

This device may be used by children of at least 8 years of age and by persons with reduced physical, sensory or mental capabilities or lacking experience or knowledge, provided they are supervised or if they have been given instructions on the safe use of the appliance and the risks involved are understood. Children must not play with the device. The cleaning and maintenance must not be done by unsupervised children.



- All packaging material must be kept out of reach of small children. Do not let children play with the packaging material, bags, boxes, etc.



- Do not pull or sit on the radiator and do not bend over or put any weight on it. Doing so may damage the radiator or detach it from the wall or fasteners, which could result in serious injury. To avoid such injuries, periodically verify that the radiator is well attached to the wall.



- Never attempt to alter or modify this product, paint it or apply stickers. This will void the warranty and may cause product malfunction or injury.

## 2. FEATURES

IP24 Splash-proof device



Class II: double insulation

### 2.2 Technical specifications of the electronics

Grid voltage	230V AC 50/60 Hz	
Power of the heating element	Mod. eBlitz Core 1000 W	1000 W
	Mod. eBlitz Core 1500 W	1500 W
	Mod. eBlitz Core 2000 W	2000 W
Insulation class	Class II	
Degree of protection against water	IP24	
Working temperature	-10 to 40°C	
Range of temperature	7 to 32°C	
Working humidity	0 to 85% without condensation	
Temperature control	Digital with control knob	

## 3. ELECTRICAL CONNECTIONS



### IMPORTANT

- When installing or servicing, verify that the radiator is switched off.
- Keep the radiator switched off until installation of the housing is done and closed.
- After the installation or the servicing operation, verify the housing is well fixed to the wall.

The electronic radiator can only be plugged to a 230 Vac grid. Respect the colours:

Brown	Phase
Grey or blue	Neutral
Black	Pilot wire

### Warning:

**If the black “pilot wire” cable is not used, safety standards require it to be insulated and not to be connected to the ground.**

The pilot wire is not used with a carrier current programming unit and must then be insulated.

A bipolar power cut-out switch is mandatory. Contacts must be separated by at least 3 mm.

It is mandatory for all circuits supplying the electrical devices to be protected by a high sensitivity differential protection device. The power cable must be connected to the grid through a junction box placed at least 25 cm from the floor, without the use of a plug. Avoid any metallic object to penetrate inside the box.

If the power cable is damaged, it must be replaced by the manufacturer, its service department or similarly qualified persons to avoid danger.

### 3.1 SPECIFICATIONS FOR INSTALLATION IN THE BATHROOM

The installation must comply with the applicable standards and installation regulations.

The radiator is made to comply with class II with an IP24 electrical protection.

Within the bathroom, the radiator can be installed in the zones 3 and 2 (see image) provided the control devices cannot be touched by the individual using the shower or the bathtub.

It must not be plugged to the earth ground.



**In a shower room, be sure to protect the power line with a 30 mA high sensitivity differential device.**

**In accordance with regulation, a phase-neutral circuit breaker must be installed with a contact distance of at least 3 mm.**

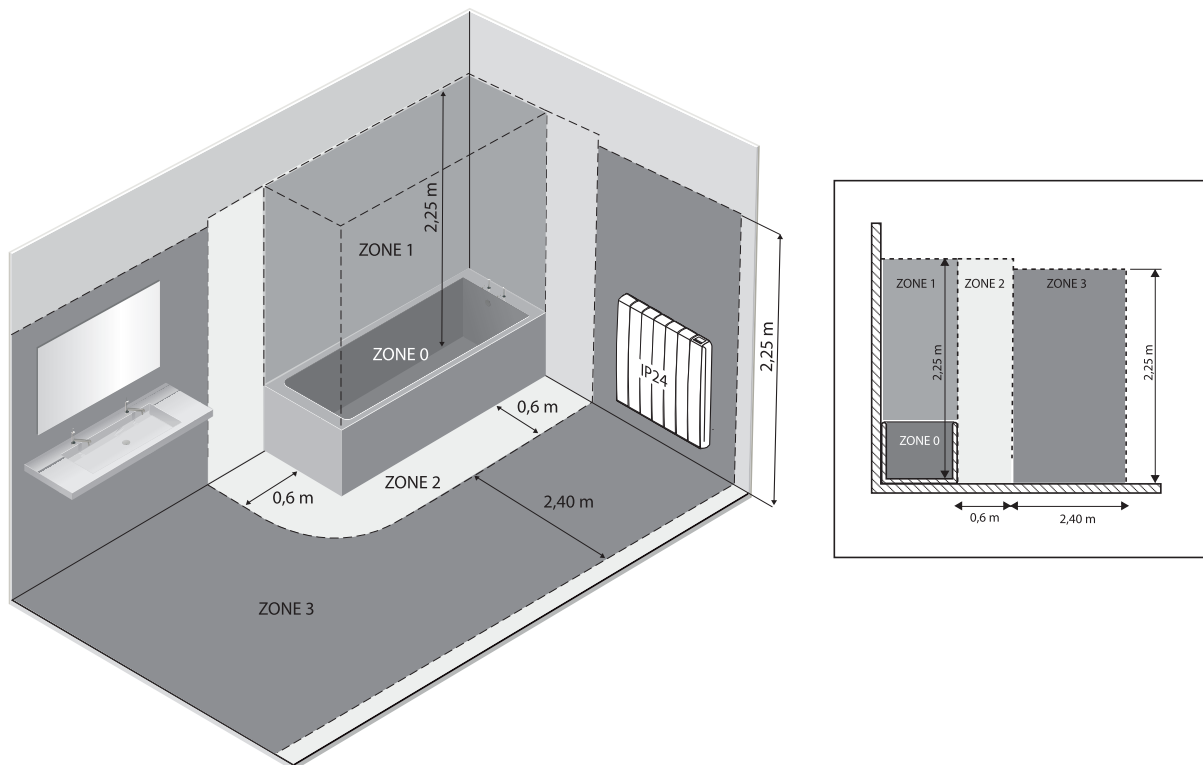

### 4. INSTALLATION OF THE DEVICE

For optimum thermal efficiency and room comfort, we recommend installing the radiator, if possible, under a window or near an area of high heat loss in the room to be heated.

The radiator must be placed with the control unit at the right. The junction box or socket must never be on or behind the radiator.

Do not install the radiator in a niche or under an electrical socket.

Curtains, furniture or other objects that can impede a correct heat distribution must be placed at a minimum distance of 50 cm from the front of the radiator.

Respect a minimum distance of 12 cm between the upper limit of the radiator and the ground.

Respect a minimum distance of 50 cm between the upper limit of the radiator and any possible shelf over the radiator.

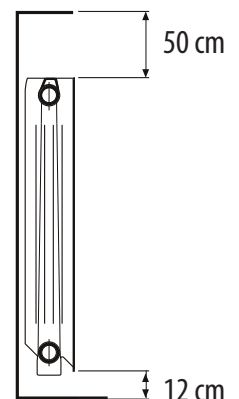

## 4.1. WALL MOUNTING OF THE RADIATOR

The radiator must be fixed to the wall using the fixing brackets supplied with the appliance.

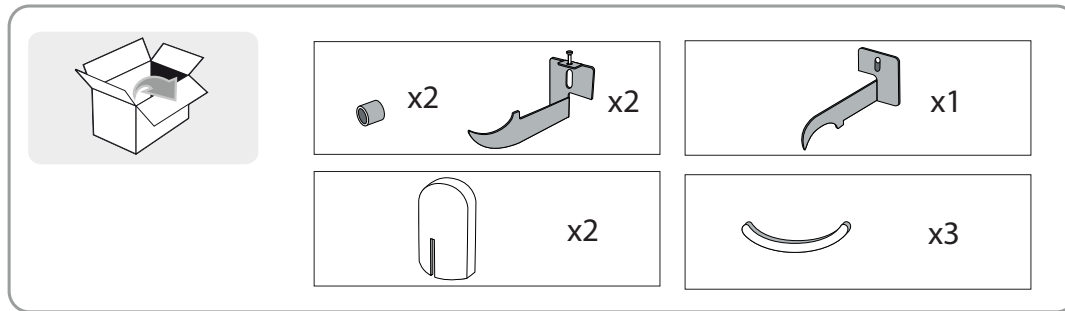

**WARNING:** the screws and dowels are not provided with the packaging, so please use screws and dowels that are suitable for the type of wall material the radiator is to be fixed to. The dowel must have a 10 mm diameter, the screw must have a 60 mm length, a 7,5 mm diameter and an hexagonal head.

Materials needed for the installation of the radiator.

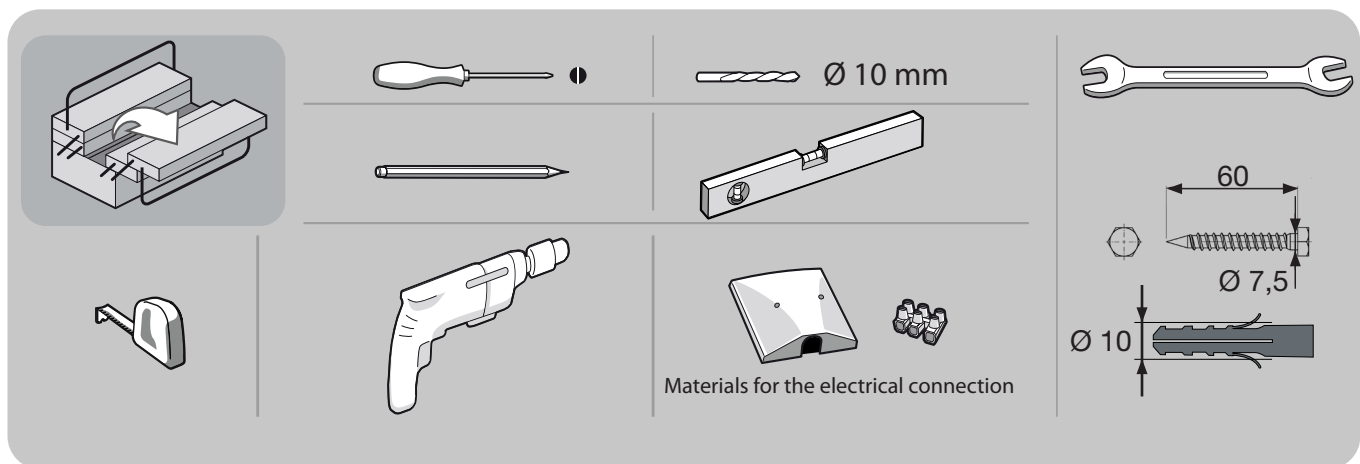

Proceed as follows for the installation:

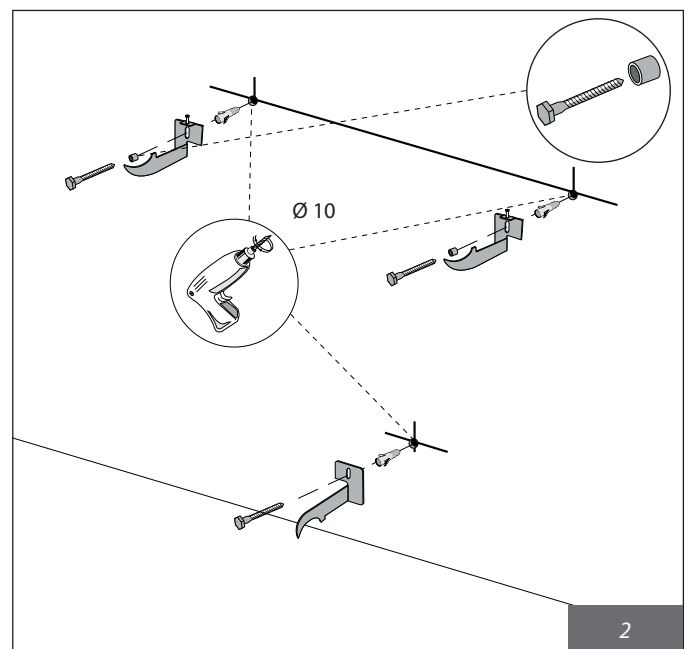
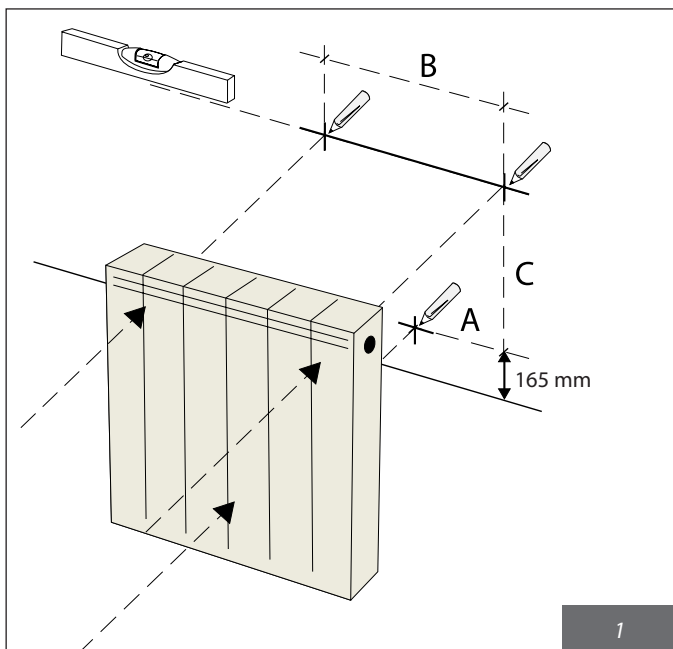

	Number of elements/Power		
	5/1000W	7/1500W	9/2000W
<b>SIDE A (mm)</b>	0	79	0
<b>SIDE B (mm)</b>	237	395	553
<b>SIDE C (mm)</b>	491	491	491

Fit the plastic protections on the brackets (Fig. 3), position the radiator and then fully screw the lower bracket down as well (Fig. 4/5).

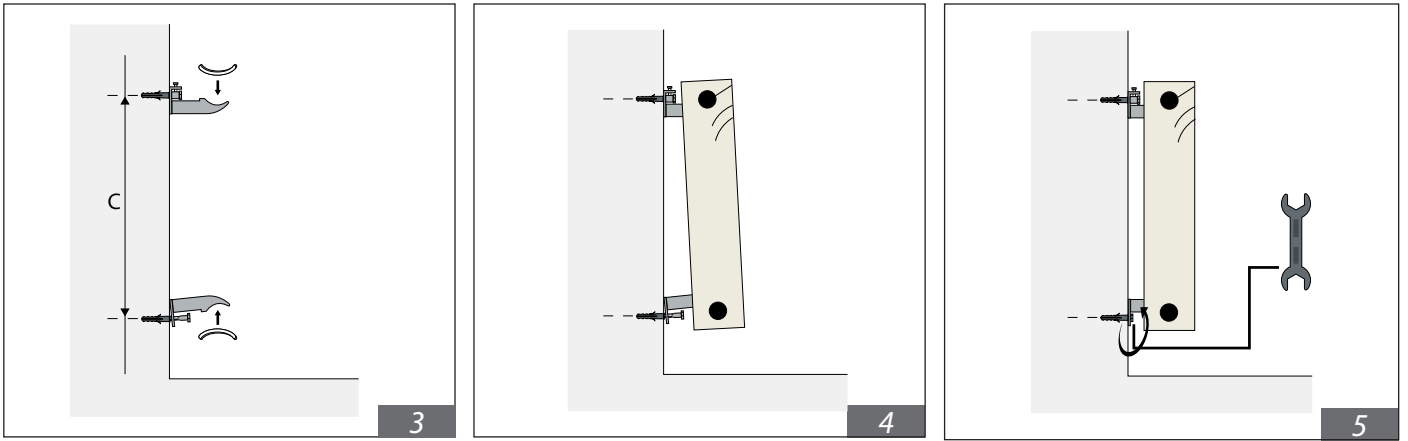

Block the radiator and cover the brackets with the special plastic cover (Fig. 6/7):

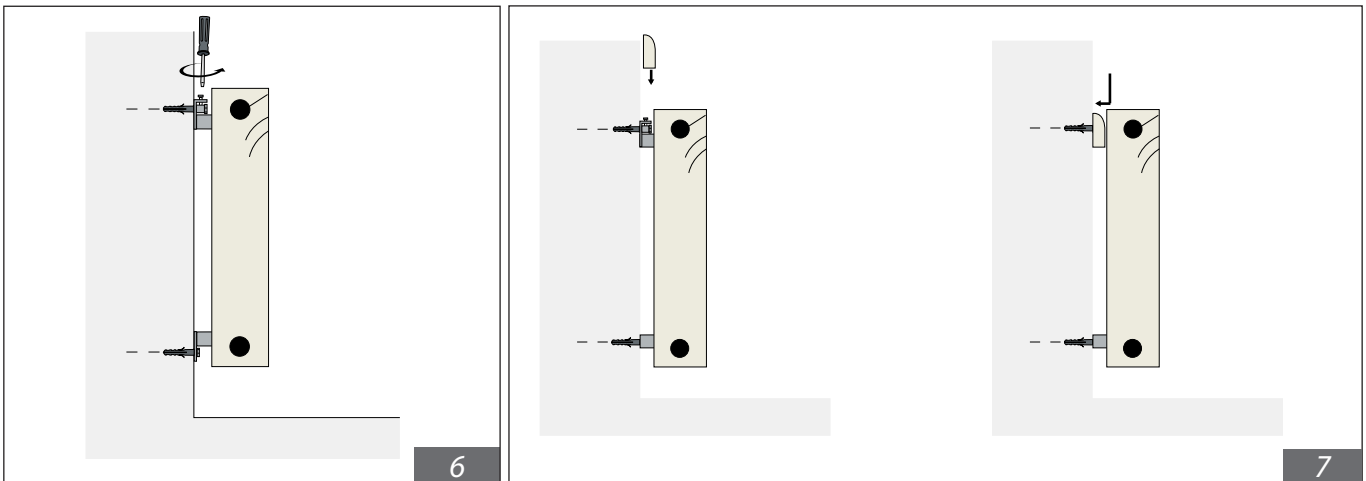

 **Point 6 of the procedure cannot be completed until the lower screw is tightened so that the radiator is firmly fixed to the wall and cannot be moved.**

See chapter 3 "Electrical connections" to connect the radiator to the electrical circuit



## 5. USE

**IMPORTANT:** an abnormal smell may occur when the radiator is first switched on. This odour diminishes and tends to disappear after a few hours of use. The room should be well ventilated after the first switching on of the radiator.

When the device is first switched on, we advise you not to use it at full power, but to select a temperature close to that of the room to be heated, e.g. select a temperature of 21° C if the room is at 18°C.

### 5.1 CONTROL PANEL

The device has five buttons, as shown in the figure:

Button	Description
+	Increment button
-	Decrement button
	Programming button: button to enter the programming mode
	Function button: selection of operating mode/OK
	Stand-by: button exclusively used to enter and exit the stand-by mode

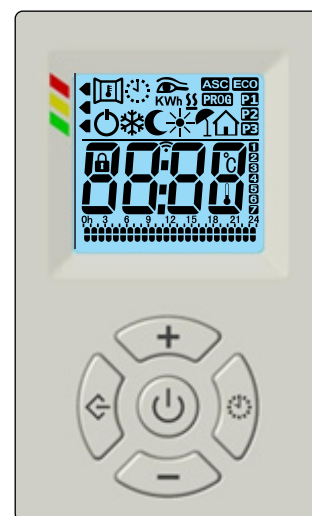



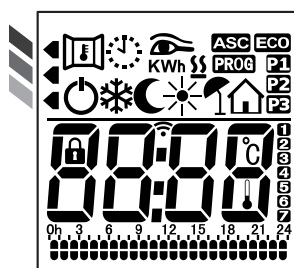



You will find on the display the following icons, which will light up according to the status of the radiator.



### 5.2 DESCRIPTION OF THE DIFFERENT USE MODES





This radiator is equipped with a series of functions and operating modes that can be selected by the user using the "Function" button . Intended operating modes: Comfort, Reduced, Frost protection, Holiday, Programming, Eco, Standby, Pilot wire.

The icons corresponding to these functions and present on the display are the following ones:

MODES	Description
	Stand-by mode: the radiator is plugged but does not heat.
	Pilot wire: the locally configured high temperatures are modified according to the commands received by the pilot wire central.
	Comfort: control without time limit on high temperature level All PILOT WIRE commands are not available.
	Reduced: control without time limit on low temperature level All PILOT WIRE commands are not available.
	Frost protection: regulation on 7°C without time limit All PILOT WIRE commands are not available.
	Holiday: the radiator enters the frost protection mode for an adjustable period of time at the discretion of the user.
	Programming: Follows the weekly programming on two temperature levels (high and low), determined by the used on an hourly basis. All PILOT WIRE commands are not available.
<b>ECO</b>	Eco: preset temperature equal to 17 °C without time limit. All PILOT WIRE commands are not available.

You can switch from one operating mode to another by pressing the "Function" button .

The special functions are:

	Open window function
<b>ASC</b>	Adaptive start control
	Button lock function
<b>kWh</b>	Consumption reading function
	Behaviour indicator
	Weekly programs

### 5.2.1 Description of the functions

#### Pilot wire mode.

This is the mode that allows the radiator to be controlled remotely.

1. Press the "Function"  key until the corresponding icon appears on the display.
2. Select the desired temperature with the «+» and «-» buttons. The control pilot wire control unit will select the operating mode.

The temperature can be set in the range 10÷32°C. When switching from pilot wire mode to comfort mode, the new comfort temperature will be the one programmed for the pilot wire. If the reduced temperature is higher, it will automatically be reduced to the comfort temperature minus 0,5 °C.

#### Comfort mode

Standard mode of the radiator to keep the ambient temperature to the set value.

1. Press the "Function"  key until the corresponding icon appears on the display.
2. Select the desired temperature with the «+» and «-» buttons.

The minimum value that can be set is equal to the reduced temperature plus 0,5 °C. The maximum value is 32 °C.

#### Reduced mode

By selecting this operating mode, the device will keep the room at the set reduced temperature.

Setting of the desired night temperature is done as follows:

1. Press the "Function"  key until the corresponding icon appears on the display.
2. Choose the temperature of the reduced level with the «+» and «-» buttons.

The minimum value that can be set is equal to the comfort temperature minus 0,5 °C. The minimum value is 7 °C.

#### Frost protection mode

By selecting this operating mode, the ambient temperature is adjusted to 7 °C.

Press the "Function"  key until the corresponding icon appears on the display.

#### Holiday mode



By selecting this function, the radiator enters the frost protection mode for an adjustable period of time, set by the user.

1. Press the "Function"  key until the corresponding icon appears on the display.
2. You can select the duration of the holiday period with the "+" and "-" buttons, from 12 hours to 40 days, in 1 hour steps from 12 to 24 hours and then in one day steps.
3. Once the wait is over, the thermostat will enter comfort mode.



## Programming mode

In this mode, the ambient temperature is maintained at the Comfort or Reduced level according to the time periods predefined or programmed by the user.

1. Press the "Function"  key until the corresponding icon appears on the display.
2. Press the "Programming" key  to choose between two of the presets (P1 or P2) and the user-defined programming (P3).

For the weekly programming, refer to the relevant section of the manual (5.3.1 and 5.3.2).

The P1 and P2 presets programs are as follows:

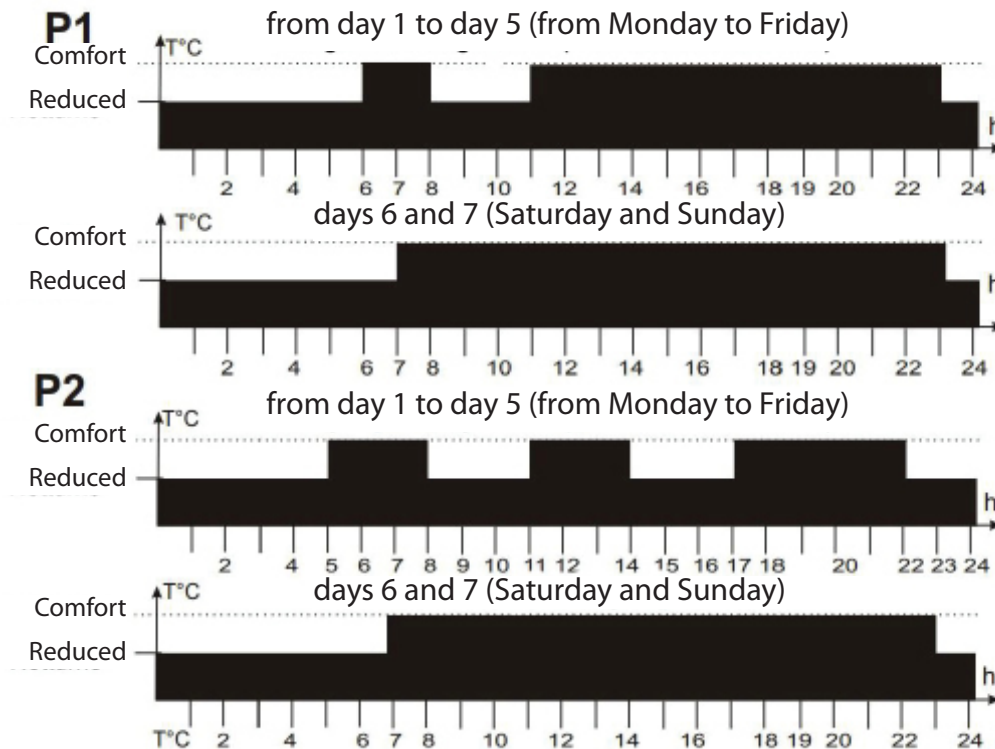

## Eco mode

With this operating mode, a predefined temperature level equal to 17°C is selected (cannot be changed) regardless of the other radiator configurations. This function allows the reduction of energy consumption, for example when the room is empty for an indefinite period.

To choose this operating mode, press the "Function" key  as necessary for the icon to be displayed.

## Open window function

The radiator can detect whether a window has been opened thanks to detection of the quick drop of ambient temperature (at least 5 °C within a maximum of 30 minutes). In such a condition, the radiator will switch off for a period of 30 minutes, at the end of which it will resume operation in the previously set state if it has detected a subsequent temperature increase of at least one degree centigrade (the window has been closed), otherwise it will remain switched off for another 30 minutes.

When the function is activated, the window symbol on the display is lit (however, it is not visible in the standby state).

When the function is activated and an open window has been detected, the window symbol on the display will blink.

When the function is deactivated, the window symbol will not be displayed.

The user can activate or deactivate this function as follows:

1. Set the radiator in stand-by mode.
2. Press the "+" key for more than 3 seconds.
3. Press the "+" key to activate or deactivate the function (ON = active, OFF = deactivated).
4. Press the "function" button  : the "ASC" function is selected, see the following description of this function.

5. Press the "+" key to activate or deactivate the function "ASC" (ON = active, OFF = deactivated).
6. Press the "function" key  to confirm the previous choices.

The system will automatically exit this sequence after 30 seconds and any modification will be saved.

### Consumption reading function

This function allows you to read the consumption of the radiator expressed in kWh.

1. Set the radiator in stand-by mode.
2. Press the "+" key for more than 3 seconds and until the data corresponding to the consumption is displayed on the screen.
3. The "+" and "-" keys can be used to scroll through the consumption menu.
4. The icons indicating the day of the week are used to indicate the type of consumption:

- 1 = current day
- 2 = previous day
- 3 = current week
- 4 = previous week
- 5 = current month
- 6 = previous month
- 7 = current year
- 1 + 2 = previous year
- 1 + 3 = total
- 1 + 7 = indication of radiator power output

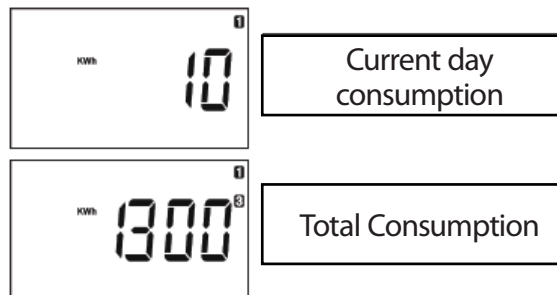

5. To quit this visualization, press the key "function" or wait 30 seconds.

**Note: it is not possible to reset the consumption readings.**

### Keyboard lock function

It is possible to lock the device to avoid any abusive or involuntary use, for example to protect children or while in use in a public space.

To activate/deactivate the key lock, press and hold the "function" key for about three seconds, the keyboard will be locked/unlocked.

Note: the radiator can be switched off or on with the "stand-by" key even if the key lock is active.

### Adaptive start control ASC

This function, if enabled, will allow the radiator to switch on earlier than programmed (up to 2 hours earlier) to ensure that the room has reached the desired temperature by the set time.

To activate/deactivate this function, refer to the previous paragraph "Open window function".

When the function is activated, the corresponding symbol on the display is lit up with the programming operating mode (however, it is not visible in the stand-by state).

### Behaviour indicator

You will find on left side of the display an indicator bar that shows the set temperature level.

It is an immediate visualisation of the necessary consumption, since the higher the set temperature, the higher the energy consumption. We must note that the correct temperature for heating a room is between 19 and 20 °C.

When the consumption indicator is at the green symbol, you are at a temperature level below or equal to the recommended temperature.

The temperature ranges associated with the colour are:

Colour	Temperature interval in °C
Green	< = 19
Orange	19,5 ÷ 24
Red	24,5 ÷ 32

## 5.3 USE OF THE RADIATOR

To switch the device on/off, press the stand-by button .









**Warning: even if the device is in stand-by mode, it is still supplied with electricity.**

 When the device is in standby mode, the display shows the time, the day (numbers from 1 to 7) and the standby icon.



It is possible to select the operating mode from those described above with the "Function" button .

When the ambient temperature is lower to the one set, the radiator will switch on a start to heat the rooms and the icon  will be displayed on the screen.

### 5.3.1. Setting the current date and time

1. Set the radiator in stand-by mode.
2. Press and hold the "programming"  button for more than 3 seconds to access a menu with the following options:
  - HEJ:** to set the hour, the minutes and the day.
  - Prog:** Programming
  - EtAl:** Set-point adjustment from -5 °C to +5 °C.
3. The "+" key can be used to switch from the "Prog" selection to the "HEJ" or "EtAl" selection.
4. When "HEJ" is displayed, press the "Function" button  to confirm the selection.
5. Use the "+" and "-" buttons to set the current year and press the "Function" button  to confirm the choice.
6. Use the "+" and "-" buttons to set the current month and press the "Function" button  to confirm the choice.
7. Use the "+" and "-" buttons to set the current day and press the "Function" button  to confirm the choice.
8. Use the "+" and "-" buttons to select the day of the week between 1 (Monday), 2 (Tuesday), ..... and 7 (Sunday).
9. Press the "function" key  to confirm the choice.
10. The current time is now shown on the display, the digits indicating the time are flashing, the time can be set with the "+" and "-" keys.
11. Press the "function" key  to confirm the choice.
12. The digits that indicate the minutes are flashing, and you can set them with the "+" and "-" keys.
13. Press the "function" key  to confirm the choice, the radiator will return to the stand-by mode.
14. If no key is pressed for 30 seconds, the system will return to the stand-by mode but any modification will still be saved.

### 5.3.2. Programming

1. Set the radiator in stand-by mode.
2. Press and hold the "programming" button  for more than 3 seconds to access a menu with the following options:
  - HEJ:** to set the hour, the minutes and the day.
  - Prog:** Programming
  - EtAl:** Set-point adjustment from -5 °C to +5 °C.
3. The "+" key can be used to switch from the "Prog" selection to the "HEJ" or "EtAl" selection.
4. When "Prog" is displayed, press the "Function" button  to confirm the selection.
5. Use the "+" and "-" buttons to select the comfort temperature level (full bar in the lower part of the display) for each hour of the day or the reduced temperature level (short bar in the lower part of the display) for day 1 (Monday).

6. Press the "function" key  to confirm the the programming choice of the first day (day 1 Monday).
7. Repeat the same operation to program the rest of the days 2 to 7.

The weekly programming is now complete and remains stored as the P3 preset and can be modified by repeating the operation described above.



**Note: The "comfort" and "reduced" temperatures are those programmed in the two respective operating modes. It is not possible to select a reduced temperature higher than the comfort temperature, the electronic system does not allow this.**

During operation, it is possible to change the temperature of the current time zone by pressing the "+" and "-" buttons.

### 5.3.3 Calibration

Allows you to adjust the calibration of the temperature sensor (+/- 5 °C) if the displayed ambient temperature is different from the room temperature.

The temperature in a room is different at each point, so it is possible that the temperature reached is different from that set on the radiator. You can correct the difference with the calibration function. Before using this function, it is necessary to run the radiators for at least 6 hours, so that the ambient temperature can be stabilised, the difference can then be corrected by adding or subtracting it from the displayed temperature.

1. Set the radiator in stand-by mode.
2. Press and hold the "programming" button  for more than 3 seconds to access a menu with the following options:
  - HEJ:** to set the hour, the minutes and the day.
  - Prog:** Programming
  - EtAl:** Set-point adjustment from -5 °C to +5 °C.
3. The "+" key can be used to switch from the "Prog" selection to the "HEJ" or "EtAl" selection.
4. When "EtAl" is displayed, press the "Function" button  to confirm the selection.
5. Use the "+" and "-" buttons to set the set-point from -5 °C to +5 °C, press the "Function" button  to confirm the selection.
6. If no key is pressed for 30 seconds, the system will return to the stand-by mode but any modification will still be saved.

#### Example 1:

if the temperature set on the radiator is at 20°C but the room is at 22°C, you must add 2°C.

$$\text{EtAl} = + 2 \text{ } ^\circ\text{C}$$

#### Example 2:

if the temperature set on the radiator is at 20°C but the room is at 18°C, you must subtract 2°C.

$$\text{EtAl} = - 2 \text{ } ^\circ\text{C}$$

## 6. RADIATOR CLEANING

---

For your safety, before any maintenance operation, switch off the power supply to your device before cleaning it. Carry out the cleaning operations with the radiator switched off and cold.

Do not use abrasive or corrosive products for the heating body, use soapy water for example, then wipe the body with a soft cloth.

When cleaning the plastic part of the thermostat, use only a dry cloth and avoid contact with chemicals or alcohol.

## 7. MALFUNCTIONS

In the event of a malfunction, do not use the appliance and disconnect it from the power supply. For repairs, do not open the radiator, only use authorised technicians who are allowed to work on this type of product.

If the power cable is damaged, it must be replaced by the manufacturer, its service department or similarly qualified persons to avoid danger.

The manufacturer declines all responsibility for any damage to persons, animals and things resulting from improper handling or intervention on the radiator.

### TECHNICAL PROBLEMS TABLE

PROBLEM	RADIATOR STATUS	POSSIBLE CAUSE	SOLUTION
The radiator does not heat	Digital thermostat switched off	No electrical supply	Check that the grid voltage
The radiator does not heat	Digital thermostat active in <b>programming mode</b>	Programming expect the radiator to be on low level	Verify programming parameters
The radiator does not heat	Digital thermostat active in in comfort mode or in <b>programming mode</b>	Malfunction of the electrical resistance or the control board	Contact the after-sales service for repair.
The radiator does not heat	Digital thermostat active in <b>comfort mode, programming mode, reduced mode or frost protection mode</b>	The temperature in the room is higher than the set value	Verify the selected temperature
Heater does not heat sufficiently in comfort mode	Digital thermostat activated in the desired mode	The power output of the radiator is insufficient for the size of the room	Replace the radiator with a higher capacity radiator.
Ineffective ambient temperature control	<b>ALL</b> on the Display	Sensor is damaged	Contact the after-sales service for repair
The radiator emits a bad smell	Radiator in heating	Powder coating of a new radiator, tidying up the electrical insulation of the steatite body	After the first few hours, the smell reduces and tends to disappear
The walls behind the radiator show traces of dirt	All	During the heating phase the radiator carbonises the dust particles in the air	Clean the radiator regularly, use washable paint for the walls. Avoid smoking in the room.
The radiator does not work according to the selected programming	Programming	The day and time are not up to date due to a power failure	Set the day and time (see 5.3.1)
The temperature measured by the radiator does not match the temperature measured by a room thermostat in the room	Digital thermostat active in comfort mode or in programming mode	The radiator thermostat and the room thermostat are located in different positions and read two different temperatures.	To calibrate both readings, use the EtAl parameter, see section 5.3.3. The correction must be made when the room is heated.

## 8. WARRANTY

The radiator is guaranteed against manufacturing defects for 2 years from the date of purchase: 2 years for the thermostat and 10 years for the heating element.

The warranty will be taken into consideration on presentation of the dated invoice.

The installation must comply with applicable standards and regulations.

Wear parts, expendable materials and accessories are excluded from the warranty as well as any breaking due to unauthorised transport and disassembling.

## 9. ENVIRONMENT

---



The symbol on the device indicates the separate collection of electrical and electronic devices.

Electrical products should not be disposed of with household waste. Please recycle them at the designated collection points. Contact your local authority or dealer for advice on recycling. Please recycle the packaging at the designated collection points.



### **Warning!**

**Incorrect disposal of electrical appliances could result in penalties.**

## 10. DECLARATION OF CONFORMITY

---

### 10.1

We hereby declare for

**FONDITAL S.p.A.**

via cerreto 40, 25079 Vobarno (BS) Italia

that

**ELECTRICAL RADIATORS  
FOR HEATING**

Model

**eBlitz Core**

produced by FONDITAL S.p.A.

are manufactured according to European directives and European regulations:

- DIRECTIVE 2014/35/UE : "Low Voltage"
- DIRECTIVE 2014/30/UE: "Electromagnetic Compatibility"
- DIRECTIVE 2012/19/UE: "WEEE"
- DIRECTIVE 2011/65/UE: "RoHS"
- DIRECTIVE 2009/125/CE: "Ecodesign"
- REGULATION (UE) 2015/1188: "Ecodesign"
- REGULATION (CE) 1907/2006: "REACH"

and in accordance with rules:

- EN 60335-1:2012+A11:2014 + A13:2017 +A1:2019 + A2:2019 + A14:2019.
- EN 60335-2-30:2009 + A11:2012 + A1:2020 +A12:2020.
- EN 62233:2008
- EN 55014-1:2017
- EN 55014-2:2015

FONDITAL S.p.A.

Vobarno, 15/09/2021

## DECLARATION OF CONFORMITY

We hereby declare for

**FONDITAL S.p.A.**

via cerreto 40, 25079 Vobarno (BS) Italy  
that  
ELECTRICAL RADIATORS  
FOR HEATING

Model  
**eBLITZ Core**

produced by FONDITAL S.p.A.

are manufactured according to Regulations:

- Electrical Equipment (Safety) Regulations 2016 and amendments.
- Electromagnetic Compatibility Regulations 2016 and amendments.
- The Restriction of the Use of Certain Hazardous Substances in Electrical and Electronic Equipment Regulations 2012.

and in accordance with rules:

- BS EN 60335-1:2012+A11:2014 + A13:2017 +A1:2019 + A2:2019 + A14:2019.
- BS EN 60335-2-30:2009 + A11:2012 + A1:2020+A12:2020.
- BS EN 62233:2008
- BS EN 55014-1:2017
- BS EN 55014-2:2015

FONDITAL S.p.A.

Vobarno, 15/09/2021

**11. Information requirements for electric local space heaters in accordance with Annex II, point 3.a.i.2, of the Regulation (EU) 2015/1188 of 28 April 2015 implementing Directive 2009/125/EC.**

Model identifiers: <b>eBlitz Core 1000W /1500W/2000W</b>					
Item	Symbol	Value	Unit	Item	Unit
<b>Heat output</b>				<b>Type of heat output/room temperature control</b>	
Nominal heat output	Pnom	1,0/1,5/2,0	kW	single stage heat output and no room temperature control	no
Minimum heat output (indicative)	Pmin	N.A.	kW	Two or more manual stages, no room temperature control	no
Maximum continuous heat output	Pmax,c	1,0/1,5/2,0	kW	with mechanic thermostat room temperature control	no
<b>Auxiliary electricity consumption</b>				with electronic room temperature control	no
At nominal heat output	elmax	1,0/1,5/2,0	kW	electronic room temperature control plus day timer	no
At minimum heat output	elmin	n.d.	kW	electronic room temperature control plus week timer	<b>yes</b>
In standby mode	eISB	0,35	W	<b>Other control options</b>	
				room temperature control, with presence detection	no
				room temperature control, with open window detection	<b>yes</b>
				with distance control option	no
				with adaptive start control	<b>yes</b>
				with working time limitation	no
				with black bulb sensor	no
Contact details	<b>Fondital S.p.A.</b> 25079 VOBARNO (Brescia) Italy - Via Cerreto, 40 Tel. +39 0365/878.31 - Fax +39 0365/878.304 e mail: info@fondital.it - www.fondital.com				

**12. RANGE AND SIZES**

Model	Power output	elements	Width	Height	Depth
	W	n°	mm	mm	mm
eBlitz Core 1000 W	1000	5	473	577	97
eBlitz Core 1500 W	1500	7	628	577	97
eBlitz Core 2000 W	2000	9	788	577	97