

MANUALE DELLE ISTRUZIONI PER L'USO - RADIATORE ELETTRICO pag. 1

INSTRUCTIONS - ELECTRIC RADIATOR page 13

MODE D'EMPLOI - RADIATEUR ÉLECTRIQUE page 25

IT

GB

FR

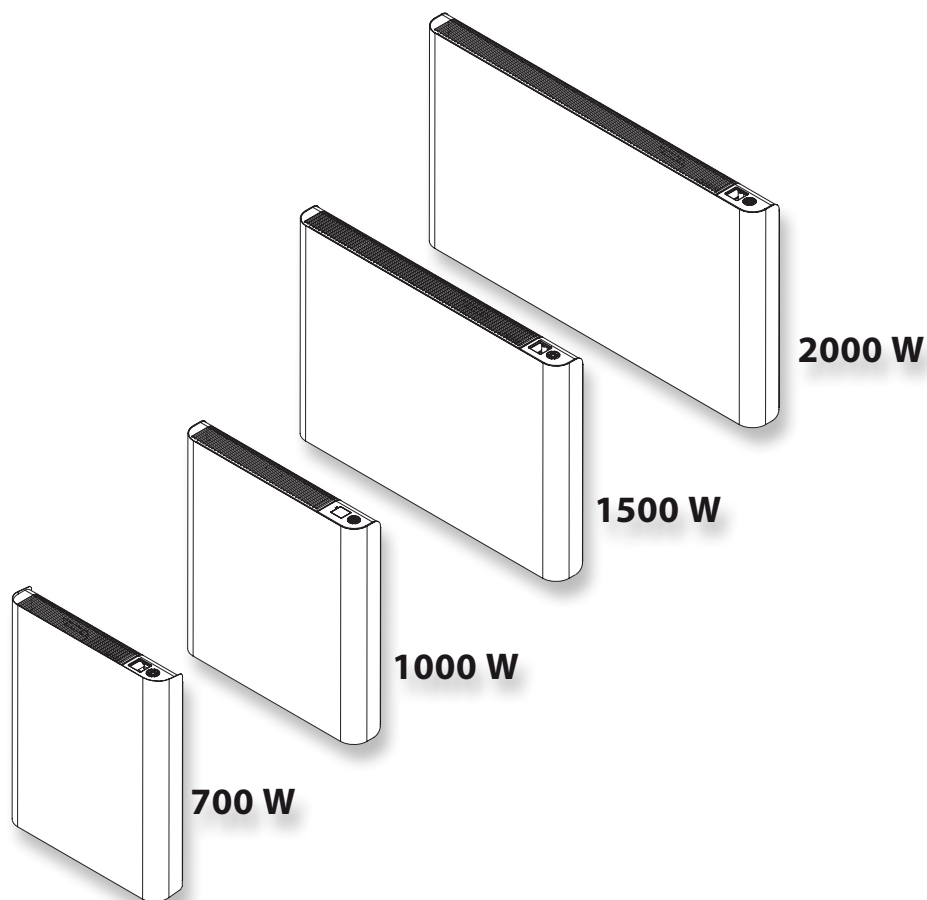

FIG. 1

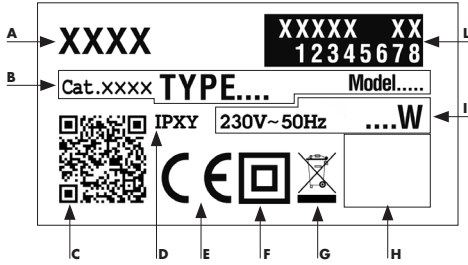
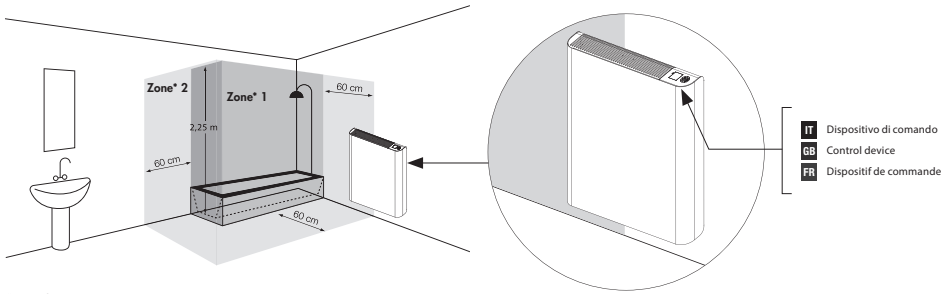

FIG. 2



\* Zona / Zone

FIG. 3

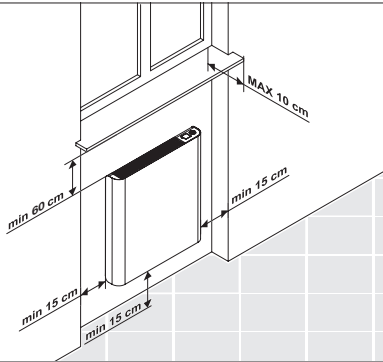

FIG. 4

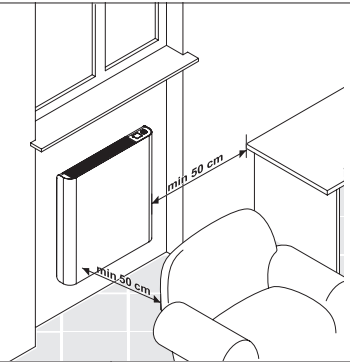

FIG. 5

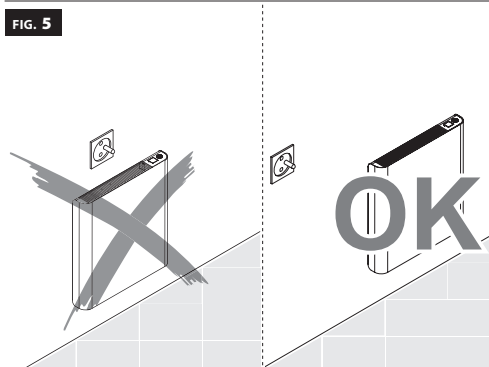

FIG. 6

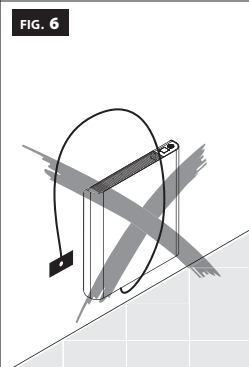
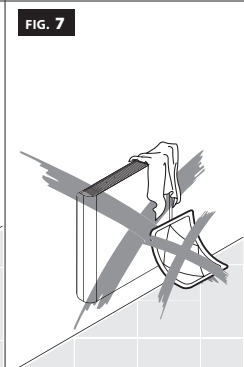
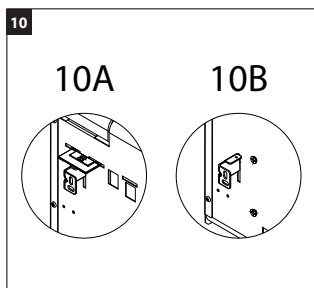
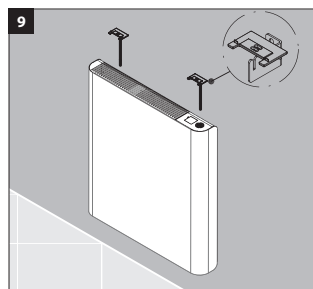
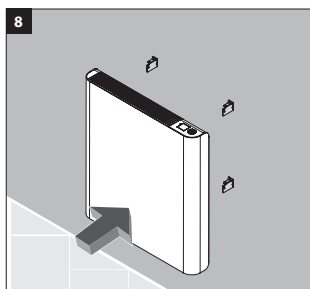
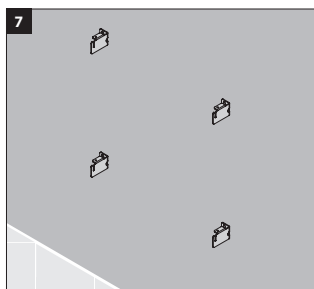
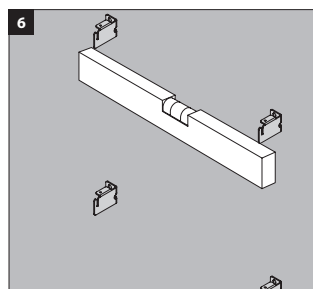
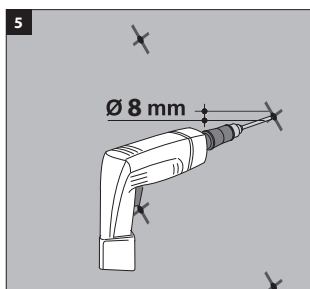
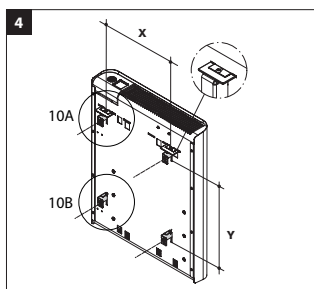
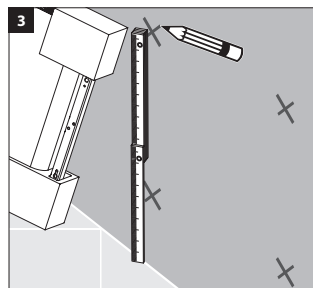
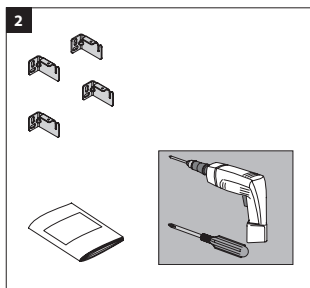
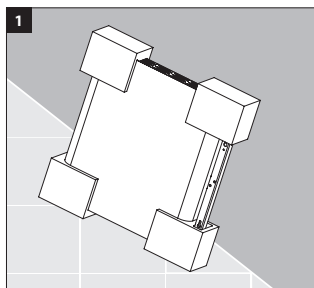

FIG. 7



SCHEMA 1 / SCHEME 1 / SCHÉMA 1

Potenza / Power / Puissance (W)	X (cm) / (cm) / (cm)	Y (cm) / (cm) / (cm)
700	30	32,3
1000	36	32,3
1500	64	32,3
2000	85	32,3



SCHEMA 2 / SCHEME 2 / SCHÉMA 2

Potenza / Power / Puissance (W)	X (cm) / (cm) / (cm)	Y (cm) / (cm) / (cm)
700	17	32,5
1000	24	32,5
1500	52	32,5
2000	73	32,5

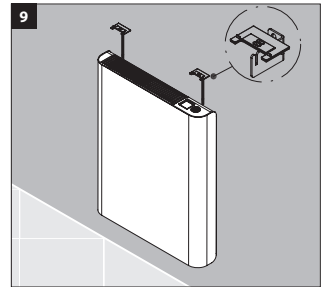
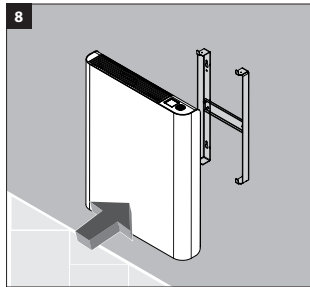
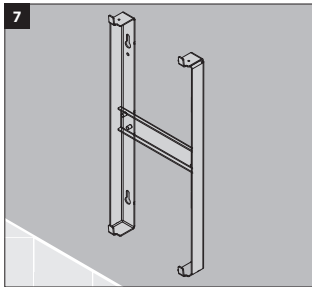
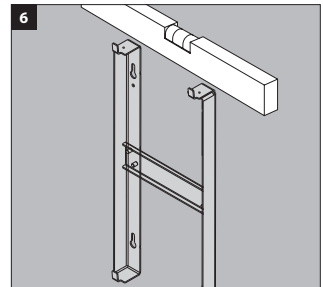
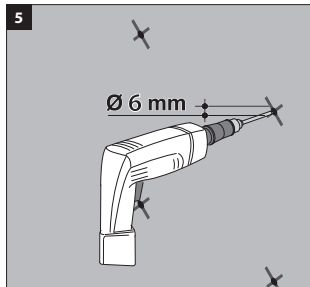
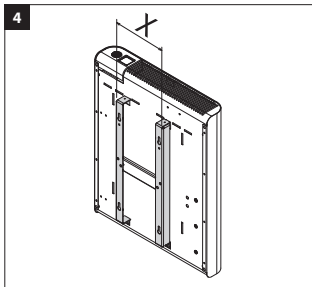
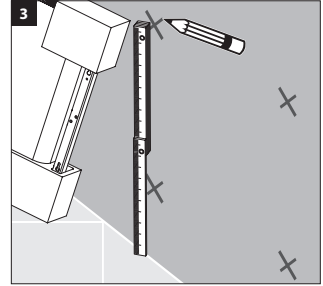
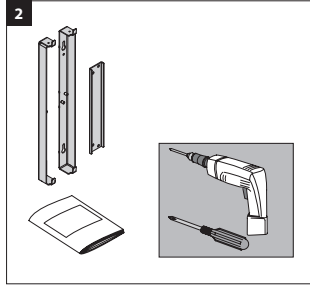
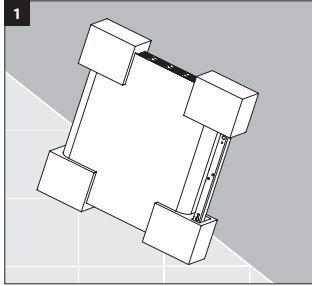



## SIMBOLOGIA USATA NEL MANUALE



ATTENZIONE!  
PERICOLO PER LA SICUREZZA DELLE PERSONE,  
DEGLI ANIMALI DOMESTICI E DEI BENI.



ATTENZIONE!  
PERICOLO DI SCOSSA ELETTRICA.



ATTENZIONE!  
PERICOLO DI DANNI AL PRODOTTO.



ATTENZIONE!  
TEMPERATURE ELEVATE.  
PERICOLO DI SCOTTATURA.



CONSIGLIO PER IL BUON  
FUNZIONAMENTO.



NON COPRIRE!

## ATTENZIONE



**AVVERTIMENTO** - Alcune parti di questo prodotto possono diventare molto calde ed essere causa di scottature. Particolare attenzione deve essere prestata in presenza di bambini o persone vulnerabili.



I bambini di età inferiore ai 3 anni, se non sorvegliati, devono essere tenuti a distanza dal radiatore.

I bambini di età compresa tra 3 e 8 anni dovrebbero poter esclusivamente accendere / spegnere l'apparecchio, posto che questo sia installato nella sua normale posizione di funzionamento ed essi siano sorvegliati o siano stati adeguatamente istruiti sull'uso in sicurezza dell'apparecchio, avendo compreso i rischi connessi al suo utilizzo.

I bambini di età compresa tra 3 e 8 anni non devono disconnettere, regolare o pulire l'apparecchio, nè effettuarne la manutenzione.

L'apparecchio può essere utilizzato da bambini di età non inferiore a 8 anni e da persone con ridotte capacità fisiche, sensoriali o mentali, o prive di esperienza o della necessaria conoscenza, purché sotto sorveglianza oppure dopo che le stesse abbiano ricevuto istruzioni relative all'uso sicuro dell'apparecchio e alla comprensione dei pericoli ad esso inerenti. I bambini non devono giocare con l'apparecchio. La pulizia e la manutenzione destinata ad essere effettuata dall'utilizzatore non deve essere effettuata da bambini senza sorveglianza.



Non installare l'apparecchio:  
- immediatamente sotto o davanti ad una presa di corrente o ad una scatola di derivazione (Fig. 5)  
- a contatto con il muro o con il pavimento  
- vicino a tende, altri materiali infiammabili, combustibili o recipienti in pressione.



**ATTENZIONE:**  
Rispettare le distanze indicate nelle figure 3,4.



Installare e utilizzare l'apparecchio solo come indicato nelle presenti istruzioni.



Se il cavo di alimentazione è danneggiato, deve essere sostituito dal costruttore o dal suo servizio di assistenza tecnica o da altro personale qualificato al fine di evitare un pericolo. Non utilizzare l'apparecchio se lo stesso o il controllo elettronico sono danneggiati.



Assicurarsi che la linea di alimentazione sia dotata di un dispositivo che permetta il sezionamento dell'apparecchio dalla rete domestica, incluso il Filo Pilota, quando presente, secondo la normativa vigente.



**ATTENZIONE:** per evitare surriscaldamenti pericolosi non coprire in nessun caso l'apparecchio (Fig.7). Non ostruire il flusso dell'aria inserendo materiali all'interno.

## 1. CARATTERISTICHE DELL'APPARECCHIO

Tensione di alimentazione: 230 V~ 50 Hz

Classe di isolamento: II 

Grado di protezione: IP24

Potenza [W]	Lunghezza [cm]	Altezza [cm]	Peso [kg]	Corrente Nominale [A]
700	47	58	15,5	3
1000	54	58	17,8	4,3
1500	82	58	23	6,5
2000	103	58	30,5	8,6

**Tabella 1**



I dati tecnici dell'apparecchio sono indicati nell'etichetta caratteristiche posta sul lato del radiatore (Fig. 1).

A Marchio/Fabbricante	F Doppio isolamento
B Modello, type, categoria	G Modalità di smaltimento
C Codice Bidimensionale (QR)	H Marchi di Qualità
D Grado di protezione	I Tensione di alimentazione e Potenza
E Marcatura CE	L Numero di serie

## 2. INFORMAZIONI GENERALI



Disimballare l'apparecchio con cura, appoggiarlo sugli angolari in polistirolo o su un tappeto.

Il contenuto dell'imballo è:

- l'apparecchio
- kit di fissaggio
- manuale d'istruzione



Leggere attentamente e integralmente le istruzioni prima dell'installazione e dell'uso. Conservarle inoltre per consultazioni future.



Installare e utilizzare l'apparecchio solo come indicato nelle presenti istruzioni.



Queste istruzioni non coprono ogni possibile situazione che possa presentarsi. Fare sempre ricorso al buon senso e alla prudenza nell'installazione, nel funzionamento e nella conservazione dell'apparecchio.



È vietato alterare in qualsiasi modo le caratteristiche dell'apparecchio e rimuovere qualsiasi parte fissa compresi i tappi. Assicurarsi che l'apparecchio sia integro. Non utilizzare l'apparecchio se danneggiato, ma contattare il rivenditore o personale qualificato.



I materiali utilizzati per l'imballaggio sono riciclabili. Si consiglia quindi di riporli negli appositi contenitori per la raccolta differenziata.

## 3. POSIZIONAMENTO ED INSTALLAZIONE



L'apparecchio è costruito per il riscaldamento dei locali ad uso domestico o simile. Non deve essere adoperato per altri scopi. L'apparecchio deve essere utilizzato per l'installazione fissa a parete, come prescritto nelle presenti istruzioni. Installare l'apparecchio con il termostato posizionato in basso (Fig. 2).



Nella stanza da bagno (dotata di vasca o di doccia) installare l'apparecchio al di fuori della zona 1. Installare l'apparecchio in modo tale che il controllo elettronico e gli altri dispositivi di comando non possano essere toccati da una persona che si trovi nella vasca da bagno o nella doccia. È vietato l'utilizzo di spina per il collegamento del radiatore.



**Per i radiatori già provvisti di spina seguire le avvertenze riportate a pag 11.**



Rispettare le distanze indicate nelle figure 3,4.



Non installare l'apparecchio:

- immediatamente sotto o davanti ad una presa di corrente o ad una scatola di derivazione (Fig. 5)
- a contatto con il muro o con il pavimento
- vicino a tende, altri materiali infiammabili, combustibili o recipienti in pressione.



Verificare che non ci siano tubi o cavi elettrici all'interno della parete che possano essere danneggiati durante il fissaggio.



L'apparecchio è equipaggiato con un sensore in grado di rilevare l'apertura di una eventuale finestra presente sopra di esso. Per il corretto funzionamento della funzione "Finestra Aperta" si consiglia di verificare e di attenersi alle prescrizioni riportate nel Cap. 4.3.2 prima del fissaggio a parete.

### 3.1 FISSAGGIO A PARETE



Viti e tasselli non inclusi



Assicurarsi che le viti e i tasselli siano adatti al tipo di parete su cui verrà installato l'apparecchio. Per qualsiasi dubbio rivolgersi a personale qualificato o al rivenditore.



Durante l'installazione assicurarsi che il cavo di alimentazione sia scollegato dalla linea elettrica.



Seguire la sequenza d'installazione presente nell'anta pieghevole della copertina (Schema 1), rispettando la distanza minima tra la parte inferiore del radiatore ed il pavimento (Fig. 3).

### 3.2 COLLEGAMENTO ELETTRICO



**ATTENZIONE**

L'installazione va fatta eseguire a un tecnico specializzato e in conformità con le norme vigenti nel rispettivo paese.

Quando l'apparecchio viene installato, assicurarsi che non sia alimentato elettricamente e che l'interruttore generale dell'impianto sia aperto in posizione "0".



L'alimentazione dell'apparecchio è a 230 V ~ 50 Hz. Assicurarsi che la linea elettrica sia adeguata ai dati riportati in tabella 1.



Assicurarsi che la linea di alimentazione sia dotata di un dispositivo che permetta il sezionamento dell'apparecchio dalla rete domestica, incluso il Filo Pilota, quando presente, secondo la normativa vigente.

In caso di installazione in locali da bagno la linea elettrica deve essere dotata di un dispositivo di protezione differenziale ad alta sensibilità con corrente nominale differenziale di intervento di 30 mA.

La linea di alimentazione e la centralina del Filo Pilota devono essere protetti con il medesimo differenziale.

Realizzare la connessione elettrica all'interno di una scatola di derivazione.

Nel caso di locali umidi (cucina, bagno) il collegamento dell'apparecchio al circuito deve essere localizzato ad almeno 25 cm dal pavimento.

Rispettare rigorosamente lo schema di collegamento elettrico riportato nella figura 8.



**Se il Filo Pilota non è collegato alla centralina di programmazione, va terminato ed isolato. Non collegare in alcun caso il Filo Pilota a terra.**



Assicurarsi che il cavo di alimentazione non possa in nessun modo entrare in contatto con la superficie dell'apparecchio (Fig.6).

### 4. REGOLAZIONE E FUNZIONAMENTO



L'apparecchio è costruito per riscaldare l'ambiente. Alcune parti di questo prodotto possono diventare molto calde ed essere causa di scottature. Particolare attenzione deve essere prestata in presenza di bambini o persone vulnerabili.



Mantenere materiali combustibili, infiammabili e i recipienti in pressione (ad esempio bombole spray, estintori) ad almeno 50 cm dall'apparecchio. Non vaporizzare sostanze di alcun tipo sulla superficie.



Non toccare l'apparecchio con le mani o i piedi bagnati o umidi. Non bagnare il controllo elettronico con acqua o altri liquidi. Nel caso in cui dovesse succedere staccare l'alimentazione di corrente e lasciar asciugare completamente l'apparecchio.



L'installazione dell'apparecchio ad altitudini elevate provoca un aumento della temperatura dell'aria riscaldata.



In occasione della prima accensione è normale che l'apparecchio rilasci odore che sparirà in breve tempo. Si consiglia di arieggiare l'ambiente dopo il primo utilizzo.



Durante l'accensione dell'apparecchio in ambienti freddi è possibile che questo emetta dei rumori metallici, dovuti alla dilatazione dei materiali.

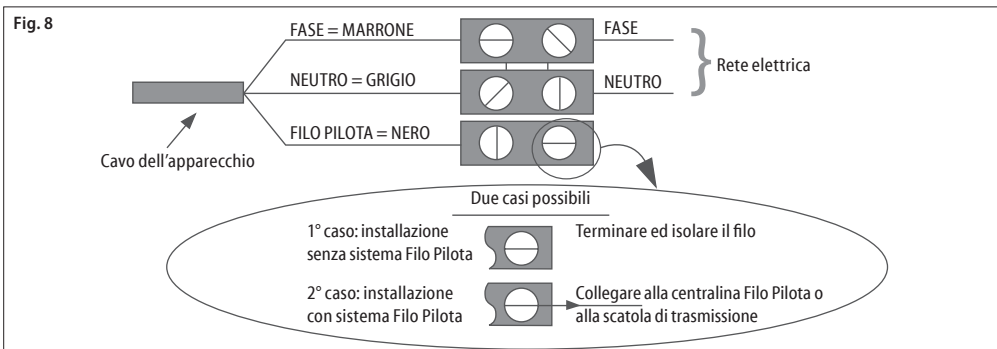

## UTILIZZO DEL RADIATORE DAL PANNELLO DI CONTROLLO:

## PANNELLO DI CONTROLLO

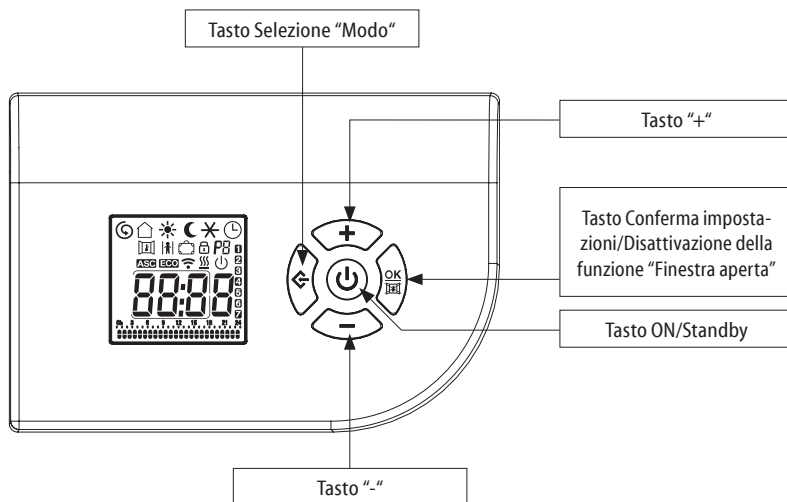

## DISPLAY

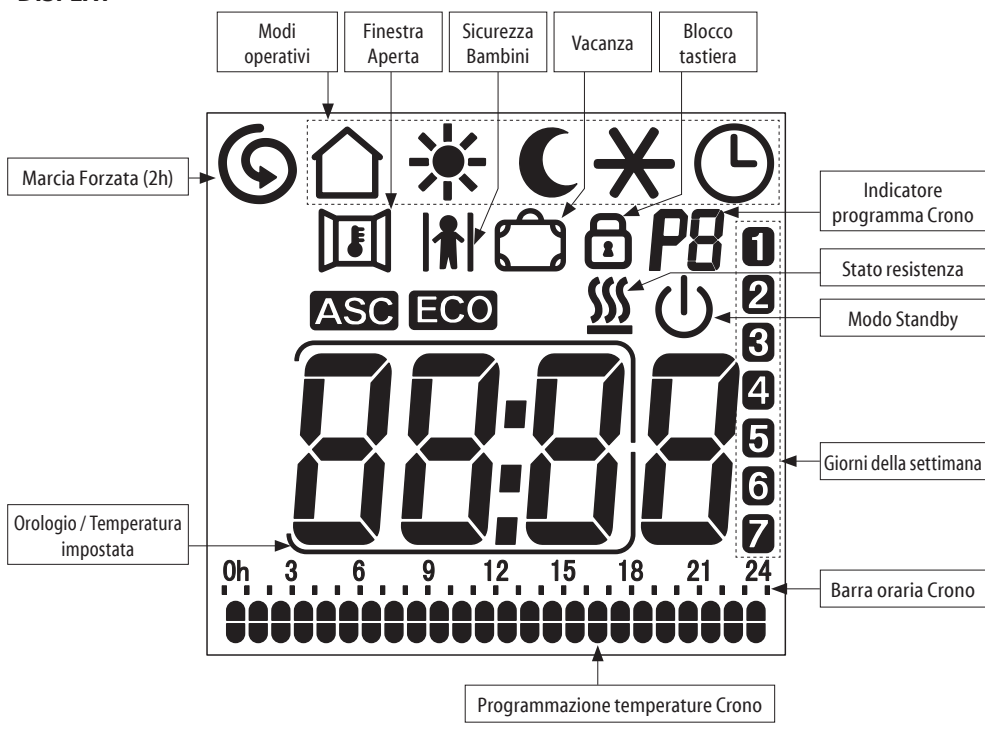

## 4.1 MODE ON/STANDBY



Nel modo "Standby" il display visualizza l'icona , l'ora e il giorno della settimana. Tutti i modi, compreso il "Filo Pilota", sono sospesi, ma l'apparecchio rimane sotto tensione in attesa della ricezione di un comando.



Per accendere o spegnere l'apparecchio premere il tasto "Standby". Lo scaldasalviette si accende nel modo operativo precedente lo spegnimento ed emette un segnale acustico.

Il display visualizza l'ora in modo "Crono", mentre negli altri modi visualizza la temperatura impostata. L'apparecchio avvisa con un doppio segnale acustico l'ingresso nel modo "Standby" e con un segnale acustico prolungato l'uscita da questo.

### PRIMA ACCENSIONE :







"Regolare il giorno della settimana utilizzando i tasti "+" e "-" (1=LUN, 2=MAR, ... 7=DOM), quindi confermare premendo il tasto di selezione "Modalità". L'ora inizia a lampeggiare. Allo stesso modo, regolare l'ora utilizzando i tasti "+:+" e ":-:" e confermare con il tasto di selezione "Mode". Ripeti la stessa procedura per i minuti. L'anno di inizio è il 2021."

## 4.2 MODI OPERATIVI

L'apparecchio mette a disposizione 6 modi operativi che consentono di riscaldare l'ambiente nel modo più appropriato alle proprie esigenze.



Premere il tasto "Modo" per scegliere il modo operativo desiderato. Un'icona sul display indica il modo operativo:

	Filo Pilota		Comfort
	Notte/Eco		Anti-Gelo
	Crono		Energy Saving



### FILO PILOTA

La temperatura è programmata attraverso i comandi del "Filo Pilota". Tutti i comandi del "Filo Pilota" sono attivati.



### COMFORT

La temperatura di "Comfort" corrisponde alla temperatura desiderata dal cliente. Tutti i comandi "Filo Pilota" sono disattivati.



### NOTTE/ECO

Il modo "Notte/Eco" mantiene una temperatura confortevole con un ridotto consumo di energia. Tutti i comandi "Filo Pilota" sono disattivati.



### ANTI-GELO

In modalità "Anti-Gelo" la temperatura minima è fissata a 7 °C. L'apparecchio si accende automaticamente per temperature ambiente inferiori ai 7 °C. Tutti i comandi "Filo Pilota" sono disattivati.



### CRONO

Questo modo consente di selezionare uno dei tre programmi di cronotermostatazione preimpostati, oppure il programma personalizzabile. Quest'ultimo consente una programmazione giornaliera e settimanale, con due livelli di temperatura ("Comfort" e "Notte/Eco"). Tutti i comandi "Filo Pilota" sono disattivati.



### ENERGY SAVING

Questo modo consente di ridurre i consumi, nel caso in cui la stanza venga lasciata vuota. La temperatura è fissata a 17 °C. Tutti i comandi "Filo Pilota" sono disattivati.

Quando sul display è visualizzata l'icona , la resistenza è attiva.

## 4.2.1 FILO PILOTA

Per attivare il modo "Filo Pilota":





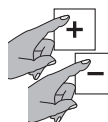



Premere il tasto "Modo" finché l'icona  non appare sul display.



L'utente può regolare solo la temperatura di "Comfort" dall'apparecchio.

Selezionare la temperatura desiderata utilizzando i tasti "+" o "-".

L'abitazione deve essere provvista di un sistema di gestione che supporti questo tipo di tecnologia. In questo caso, per verificare la trasmissione corretta degli ordini di programmazione, è possibile utilizzare lo schema seguente, in base al modo impostato:

Modo	Comfort	Notte/Eco (Comfort -3,5°C)	Anti-Gelo	Standby	Comfort - 1°C	Comfort - 2°C
Segnale da trasmettere						
Tensione tra il Filo Pilota e neutro	0 volt	230 volt	115 volt negativo	115 volt positivo	230 volt per un intervallo di 3 s	230 volt per un intervallo di 7 s

L'icona del modo selezionato dalla centralina (Standby, Comfort, Notte/Eco, Anti-Gelo) compare sul display in aggiunta all'icona .

Se il Filo Pilota non è collegato, viene automaticamente selezionato il modo "Comfort".

#### 4.2.2 COMFORT

La temperatura di "Comfort" corrisponde alla temperatura desiderata dall'utilizzatore.



Premere il tasto "Modo" finché l'icona  non appare sul display.



Selezionare la temperatura desiderata utilizzando i tasti "+" o "-".



L'intervallo di regolazione della temperatura va da 7 °C a 32 °C.

#### 4.2.3 NOTTE/ECO

In modo "Notte/Eco" la temperatura impostata deve essere uguale o inferiore alla temperatura di "Comfort". Se si cerca di impostare una temperatura di "Comfort" inferiore a "Notte/Eco", quest'ultima temperatura verrà variata di conseguenza.



Premere il tasto "Modo" finché l'icona  non appare sul display.



Selezionare la temperatura desiderata utilizzando i tasti "+" o "-".



Questo modo è raccomandato nelle ore notturne e quando la stanza rimane vuota per 2 ore o più.

#### 4.2.4 ANTI-GELO

Nel modo "Anti-Gelo" la temperatura è fissata a 7 °C. L'apparecchio si avvia automaticamente per temperature ambiente inferiori ai 7 °C e con un minimo consumo di energia impedisce al locale di raggiungere temperature di congelamento.



Premere il tasto "Modo" finché l'icona  non appare sul display.

Questo modo è raccomandato quando la stanza rimane vuota per un giorno o più.

#### 4.2.5 CRONO

Il modo "Crono" permette all'utente di selezionare uno dei tre programmi di cronotermostatazione preimpostati, oppure il programma personalizzabile. Quest'ultimo consente di impostare diverse temperature ("Comfort" e "Notte/Eco") nell'arco delle 24 ore, per ogni giorno della settimana.

### SCELTA DEL PROGRAMMA



Premere il tasto "Modo" finché l'icona  non appare sul display. Quindi premere contemporaneamente i tasti "Modo" e "+", mantenendoli entrambi premuti per almeno 3 secondi.

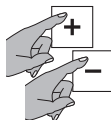

Il numero che indica il programma (P1, P2, P3 e P4) lampeggia: premere i pulsanti "+" o "-" per impostare il programma desiderato. Premere il pulsante "Modo" per confermare.

A questo punto lampeggia l'icona della funzione ASC (vedi cap 4.3.1), premere il tasto  per attivare la funzione o il tasto "-" per disattivarla.

PROGRAMMA P1	ORE	MODO
DAL LUNEDÌ AL VENERDÌ	0 - 6	Notte/Eco
	6 - 9	Comfort
	9 - 16	Notte/Eco
	16 - 23	Comfort
SABATO E DOMENICA	23 - 0	Notte/Eco
	0 - 7	Notte/Eco
	7 - 23	Comfort
	23 - 0	Notte/Eco

PROGRAMMA P2	ORE	MODO
DAL LUNEDÌ A DOMENICA	0 - 7	Notte/Eco
	7 - 23	Comfort
	23 - 0	Notte/Eco

PROGRAMMA P3	ORE	MODO
DAL LUNEDÌ AL VENERDÌ	0 - 6	Notte/Eco
	6 - 9	Comfort
	9 - 13	Notte/Eco
	13 - 23	Comfort
SABATO E DOMENICA	23 - 0	Notte/Eco
	0 - 7	Notte/Eco
	7 - 23	Comfort
	23 - 0	Notte/Eco

#### PROGRAMMA P4 - PERSONALIZZATO

Il programma "P4" permette all'utente di impostare diverse temperature ("Comfort" e "Notte/Eco") nell'arco delle 24 ore, per ogni giorno della settimana.

## REGOLAZIONE DELLA DATA E DELL'ORA

Prima di procedere con l'impostazione del programma personalizzabile P4 verificare che l'ora e il giorno della settimana siano corretti.



Se così non fosse, premere il tasto "Modo" finché l'icona  non appare sul display. Quindi premere nuovamente il tasto "Modo" mantenendolo premuto fino a quando il numero che indica il giorno lampeggia.

1  
2  
3  
4

Premere i tasti "+" o "-" per impostare il giorno della settimana corretto (1=LUN, 2=MAR,... 7=DOM). Premere il tasto "Modo" per confermare.

20:30

Ripetere la stessa procedura per regolare le ore.

20:30

A questo punto lampeggiano i minuti, utilizzare i tasti "+" o "-" per impostarli e premere il tasto  per confermare e uscire o il tasto "Modo" per entrare nell'impostazione del programma P4.

## IMPOSTAZIONE DEL PROGRAMMA P4

Per entrare nell'impostazione del programma personalizzato P4 premere il tasto "MODO" al termine della regolazione dei minuti (vedi REGOLAZIONE DELL'ORA).

A questo punto la barra oraria lampeggia e l'orologio indica l'ora che si sta programmando.

Partendo dal primo giorno selezionare la sequenza oraria desiderata utilizzando i pulsanti "+" o "-" scegliendo, per ogni ora, tra la temperatura "Comfort" (doppia tacca) e la temperatura "Notte/Eco" (tacca singola).

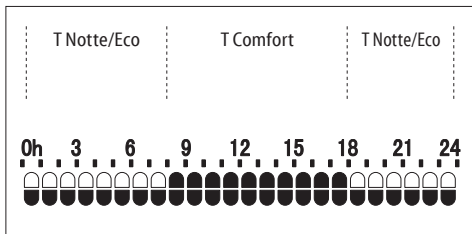

Premere il tasto "Modo" per confermare e ripetere la medesima procedura per ogni giorno della settimana.

La programmazione settimanale è ora impostata.

A questo punto lampeggia l'icona della funzione ASC (vedi cap 4.3.1), premere il tasto  per attivare la funzione o il tasto "-" per disattivarla.

## 4.2.6 ENERGY SAVING

In questo modo la temperatura è fissata a 17 °C. L' "Energy Saving" consente di ridurre i consumi nel caso in cui la stanza venga lasciata vuota ma si voglia mantenere una temperatura confortevole.



Per attivare l' "Energy Saving" premere il tasto "Modo" finché la scritta "E S" non appare sul display in sostituzione dell'ora/temperatura.

## 4.3 FUNZIONI

L'apparecchio è dotato di funzioni speciali che consentono di personalizzare ed ottimizzare l'utilizzo dell'apparecchio.

### 4.3.1 ASC

Questa funzione rileva l'inerzia della stanza per raggiungere la temperatura impostata e anticipa l'accensione dell'apparecchio per assicurare che la temperatura "Comfort" venga ottenuta all'ora impostata.

L'accensione dell'apparecchio può essere anticipata dalla funzione al massimo di 2 ore.



Questa funzione è attivabile ed operativa solo nel modo "Crono". (vedi Cap. 4.2.5)





Per l'ottimale funzionamento dell'ASC occorrono alcuni giorni di acquisizione dati.

### 4.3.2 FINESTRA APERTA

La funzione "Finestra Aperta" permette all'apparecchio di rilevare autonomamente l'eventuale apertura di una finestra in prossimità dello scaldasalviette (ad esempio durante le pulizie di casa) e di porsi in modo "Anti-Gelo", al fine di prevenire un riscaldamento inutile ed evitare sprechi di energia. Allo stesso modo è in grado di rilevare la chiusura della finestra e di ripristinare la condizione operativa precedentemente impostata.

All'accensione dell'apparecchio la funzione è già attiva, in attesa di rilevare un'eventuale apertura della finestra.



Per attivare o disattivare la funzione premere il tasto  e mantenerlo premuto fino a quando l'icona  appare o scompare dal display.



Quando viene rilevata l'apertura di una finestra l'icona "Finestra Aperta" lampeggia. In questo momento premendo il tasto  è possibile annullare l'azione della "Finestra

Aperta" fino al rilevamento di una successiva apertura.

L'icona  smette di lampeggiare.

Per garantire l'azione ottimale della funzione è consigliato installare l'apparecchio in corrispondenza di una finestra (Fig. 9).

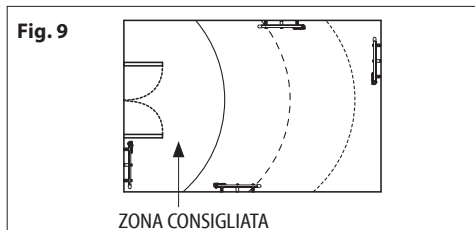

La risposta dell'apparecchio alle aperture e alle chiusure della finestra dipende da molteplici fattori, tra cui temperatura impostata sull'apparecchio, temperatura esterna, grado di ventilazione del locale in cui è installato lo scaldasalviette, posizione dello scaldasalviette all'interno della stanza, presenza di altre fonti di calore.



La funzione "Finestra Aperta" non è attivabile o disattivabile in modo "Standby".



Se l'apparecchio ha rilevato l'apertura di una finestra, tutti i modi e la funzione "Marcia Forzata (2h)" sono selezionabili ma non attivi fino al rilevamento della chiusura della finestra o all'annullamento della funzione "Finestra Aperta". Le funzioni "Sicurezza Bambini" e "Blocco Tastiera" rimangono attive e sono attivabili o disattivabili anche quando l'apparecchio ha rilevato l'apertura di una finestra.

### 4.3.3 SICUREZZA BAMBINI

Attivando la funzione "Sicurezza Bambini" la temperatura superficiale dell'apparecchio viene ridotta rispetto al normale funzionamento del modo attivo ("Comfort", "Notte/Eco",...) in modo da diminuire il rischio di scottature in caso di contatto breve ed accidentale.

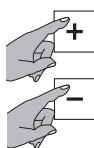

Per attivare la funzione premere contemporaneamente i tasti "+" e "-", mantenendoli entrambi premuti finché l'icona  non appare sul display.

Per disattivare la funzione ripetere la stessa operazione.

La "Sicurezza Bambini" è attivabile in ogni modo operativo e anche nella funzione "Marcia Forzata (2h)". La funzione non è attivabile se l'apparecchio si trova in "Standby".

### NOTE IMPORTANTI:

In questa funzione l'energia termica rilasciata dall'apparecchio viene ridotta e quindi è necessario un tempo più lungo per riscaldare gli ambienti.

Anche utilizzando questa funzione i bambini devono essere sorvegliati per sincerarsi che non si mettano in condizioni di pericolo.



Va comunque evitato qualsiasi contatto prolungato tra parti del corpo e l'apparecchio.

Se l'apparecchio è già in funzione o è ancora caldo per un utilizzo recente e si attiva la "Sicurezza Bambini", occorrono almeno due ore perché la temperatura scenda al valore ridotto e quindi la funzione sia operativa.

### 4.3.4 MARCIA FORZATA (2h)

Attivare la funzione "Marcia Forzata (2h)" per riscaldare la stanza più velocemente.



Per attivare la funzione premere contemporaneamente i tasti  e "+", mantenendoli entrambi premuti finché il simbolo  non appare sul display.



I minuti mancanti al termine delle due ore vengono visualizzati sul display in sostituzione dell'ora.

L'apparecchio scalda per due ore alla massima potenza ignorando la precedente impostazione di temperatura.

Per disattivare la funzione "Marcia Forzata (2h)" premere contemporaneamente i due tasti come fatto in precedenza. Dopo due ore dall'attivazione la funzione "Marcia Forzata (2h)" si disattiva comunque automaticamente e l'apparecchio ritorna nel modo operativo precedentemente selezionato.



La funzione "Sicurezza Bambini" limita la potenza dell'apparecchio anche nella funzione "Marcia Forzata (2h)".





Se l'apparecchio ha rilevato l'apertura di una finestra, la funzione "Marcia Forzata (2h)" non è attiva fino al rilevamento della chiusura della finestra o all'annullamento della funzione "Finestra Aperta" (vedi Cap. 4.3.2), mentre il conto alla rovescia al termine delle due ore prosegue.

### 4.3.5 VACANZA

Nel caso ci si assenti da casa per un numero prestabilito di giorni, è possibile impostare l'apparecchio in modo che si mantenga in modo "Anti-Gelo" durante tutto il periodo di



assenza e si riattiva automaticamente nel modo precedentemente selezionato allo scadere dei giorni impostati.

Per attivare la funzione premere contemporaneamente i tasti  e “-”, mantenendoli entrambi premuti finché l'icona  non appare sul display.

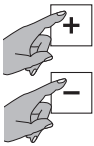

Utilizzare i tasti “+” o “-” per impostare il numero di giorni (massimo 45 giorni).

L'impostazione desiderata si autoconferma.

A questo punto il display visualizza l'icona  e il numero di giorni impostato, che decresce progressivamente con il trascorrere dei giorni.

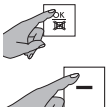

Per disattivare in qualsiasi momento la funzione premere contemporaneamente i tasti  e “-”.

### 4.3.6 BLOCCO TASTIERA

È possibile bloccare la tastiera del comando per evitare modifiche accidentali.

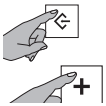

Per attivare la funzione premere contemporaneamente i tasti “Modo” e “+”, mantenendoli entrambi premuti finché l'icona  non appare sul display.

Per sbloccare la tastiera, premere contemporaneamente i due tasti come fatto in precedenza.

L'icona “Blocco tastiera” non sarà più visualizzata sul display.

**IMPORTANTE:** La funzione “Blocco Tastiera” non inibisce il tasto “Standby” che, quindi, è sempre operativo anche quando la funzione “Blocco Tastiera” è attiva.

### 4.4 RESET

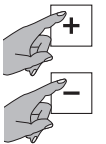

È possibile ripristinare i parametri di fabbrica premendo i tasti + e - per 4 secondi da modalità stand-by.

ATT: tutti i programmi e le modifiche effettuate verranno cancellate.

## 4.5 MOFICA SET POINT

Nel caso in cui la temperatura impostata a regime non fosse quella percepita al centro della stanza e possibile modificare i parametri di compensazione di  $\pm 5^{\circ}\text{C}$ .

Facendo un esempio pratico se la temperatura impostata sul termostato è di  $24^{\circ}\text{C}$  ma smette di riscaldare l'ambiente quando voi ne rilevate solo  $22^{\circ}\text{C}$ .

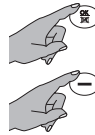

È possibile correggere il parametro letto di  $-5^{\circ}\text{C}$ . Questo parametro è possibile modificarlo da stand-by, tenendo premuto il tasto ok e -.

**IMPORTANTE:** In caso di mancanza di alimentazione tutte le impostazioni correnti vengono mantenute perdendo però l'impostazione di data e ora.

Se la mancanza di alimentazione si verifica in modo “Crono”, al ripristino l'apparecchio si riattiva in modo “Energy Saving”.

**IMPORTANTE:** In caso di mancanza di alimentazione mentre la funzione “Marcia Forzata (2h)” è attiva, al ripristino dell'alimentazione l'impostazione di data e ora viene persa e l'apparecchio esce dalla funzione ponendosi nel modo operativo precedentemente selezionato.

**IMPORTANTE:** In caso di mancanza di alimentazione mentre la funzione “Vacanza” è attiva al ripristino dell'alimentazione la funzione rimane attiva e riprende il conto alla rovescia dei giorni mancanti al momento dell'interruzione.

**IMPORTANTE:** In caso di mancanza di alimentazione mentre la funzione “ASC” è attiva al ripristino dell'alimentazione la funzione è attiva e necessita di qualche giorno per ritornare pienamente operativa.

## 5. PULIZIA



Prima di ogni operazione di pulizia assicurarsi che l'apparecchio sia spento, freddo e scollegato elettricamente.



Per la pulizia è sufficiente utilizzare un panno umido e morbido con un detergente neutro. Non usare detersivi abrasivi, corrosivi o solventi.



Per mantenere l'efficienza dell'apparecchio rimuovere la polvere dalla superficie e dall'interno dell'apparecchio almeno due volte all'anno utilizzando un aspirapolvere.

## 6. MANUTENZIONE



In caso di problemi tecnici rivolgersi a personale qualificato (riconosciuto e autorizzato dal rivenditore o dal fabbricante) o contattare il proprio rivenditore.



Qualsiasi tipo di intervento sull'apparecchio deve essere effettuato da personale qualificato che, prima di ogni operazione di manutenzione, deve assicurarsi che l'apparecchio sia spento, freddo e scollegato elettricamente.

## 7. PROBLEMI E SOLUZIONI

L'apparecchio non scalda.	<ul style="list-style-type: none"> <li>• Controllare che ci sia alimentazione elettrica e che l'apparecchio sia collegato nel modo corretto.</li> <li>• Verificare la posizione dell'interruttore generale.</li> <li>• Aumentare la temperatura impostata sul regolatore di temperatura dell'apparecchio.</li> <li>• Verificare che non vi siano indumenti che coprono il dispositivo di comando o la sonda di temperatura.</li> <li>• Se non scalda ancora, contattare il rivenditore o personale qualificato.</li> </ul>
L'apparecchio scalda in continuazione.	<ul style="list-style-type: none"> <li>• Diminuire la temperatura impostata sul regolatore di temperatura dell'apparecchio.</li> <li>• Verificare di non aver attivato accidentalmente la funzione "Marcia Forzata (2h)".</li> <li>• Verificare che non vi siano indumenti che coprono il dispositivo di comando o la sonda di temperatura.</li> <li>• Se scalda ancora, contattare il rivenditore o personale qualificato.</li> </ul>
La stanza rimane fredda.	<ul style="list-style-type: none"> <li>• Verificare che la potenza dell'apparecchio sia adeguata al fabbisogno della stanza da riscaldare.</li> <li>• Nel caso di prima accensione, la stanza impiega alcune ore per raggiungere la temperatura desiderata (mettere la regolazione al massimo non fa aumentare la temperatura più in fretta).</li> </ul>
L'apparecchio non si raffredda.	<ul style="list-style-type: none"> <li>• Per il tipo di resistenza presente, l'apparecchio diventa freddo dopo alcune decine di minuti. Aspettare il tempo necessario.</li> </ul>
L'apparecchio non risponde correttamente agli ordini derivanti dalla centralina Filo Pilota.	<ul style="list-style-type: none"> <li>• Scollegare elettricamente l'apparecchio (posizionare l'interruttore generale dell'impianto in posizione "0"). Assicurarsi che il collegamento sia fatto come prescritto in queste istruzioni (Fig.8) e che la centralina funzioni correttamente.</li> <li>• Contattare personale qualificato.</li> </ul>
L'apparecchio continua a scaldare nonostante la finestra sia aperta mentre la funzione "Finestra Aperta" è attiva.	<ul style="list-style-type: none"> <li>• Può essere necessario attendere qualche minuto prima che la funzione diventi operativa.</li> <li>• Può essere che la differenza tra temperatura esterna ed interna non sia sufficiente a rendere la funzione operativa.</li> <li>• Verificare che il posizionamento dell'apparecchio sia conforme alle prescrizioni riportate nel capitolo 4.3.2 del presente libretto.</li> <li>• Verificare che lo spazio circostante il Comando dell'apparecchio sia sgombro di eventuali ostacoli.</li> <li>• Se il problema persiste contattare il rivenditore o personale qualificato.</li> </ul>
L'apparecchio non riprende a scaldare dopo la chiusura della finestra mentre la funzione "Finestra Aperta" è attiva.	<ul style="list-style-type: none"> <li>• Può essere necessario attendere qualche minuto prima che il sensore rilevi la chiusura della finestra.</li> <li>• Verificare che lo spazio circostante il Comando dell'apparecchio sia sgombro di eventuali ostacoli.</li> <li>• Disattivare e riattivare la funzione.</li> <li>• Se il tempo di risposta della funzione dovesse rivelarsi eccessivo, potete comunque riattivare manualmente l'apparecchio.</li> <li>• Se il problema persiste contattare il rivenditore o personale qualificato.</li> </ul>
Sul display appare il messaggio "ALL".	<ul style="list-style-type: none"> <li>• La sonda di temperatura è danneggiata. Spegnere l'apparecchio e contattare il vostro rivenditore.</li> </ul>

## 8. GARANZIA



Si raccomanda di conservare l'imballo, in tutte le sue parti per l'eventuale restituzione dell'apparecchio al proprio rivenditore, l'apparecchio deve pervenire integro al fine del mantenimento delle condizioni di garanzia.

Il costruttore garantisce ai suoi clienti tutti i diritti specificati nella direttiva europea 1999/44/CE e i diritti dei consumatori riconosciuti dalle legislazioni nazionali.

La garanzia copre specificamente ogni non-conformità e difetto di produzione presente sul prodotto al momento della vendita e che si evidenzia entro due anni dalla data di acquisto e dà diritto al cliente di ottenere la riparazione gratuita del prodotto difettoso o la sostituzione nel caso non sia riparabile.

I diritti summenzionati vengono a cadere nei seguenti casi:

- difetti causati da usi diversi rispetto a quelli specificati nel presente libretto, che costituisce parte integrante del contratto di vendita;
- difetti causati da rottura accidentale, negligenza o manomissioni.

Non sono da intendersi come prestazioni in garanzia gli interventi inerenti l'installazione, l'allacciamento agli impianti di alimentazione e le manutenzioni citate nel libretto delle istruzioni. Il Costruttore declina ogni responsabilità per danni o ferite provocati direttamente o indirettamente a persone, oggetti o animali domestici come risultato della mancata applicazione delle prescrizioni riportate nel presente libretto, con particolare riferimento alle avvertenze riguardanti l'installazione la messa in servizio del prodotto e utilizzo.

Per godere dei diritti di cui sopra, il Cliente deve contattare il proprio rivenditore ed esibire una valida prova d'acquisto rilasciata dal venditore, completa della data d'acquisto del prodotto.

## 9. SMALTIMENTO



Assicurarsi che il cavo di alimentazione sia scollegato dalla linea elettrica prima di qualsiasi operazione. Per lo smontaggio seguire al contrario le fasi di fissaggio a parete (Pag. 193).

Per la rottamazione dell'apparecchio seguire la normativa vigente per lo smaltimento del fluido contenuto all'interno dello scaldasalviette e la gestione dei rifiuti.



**Avvertenze per il corretto smaltimento del prodotto ai sensi della Direttiva Europea 2012/19/EC.**

Alla fine della sua vita utile il prodotto non deve essere smaltito insieme ai rifiuti urbani.

Può essere consegnato presso gli appositi centri di raccolta differenziata predisposti dalle amministrazioni comunali, oppure presso i rivenditori che forniscono questo servizio.



Questo apparecchio è conforme alle Direttive europee:

2014/30/EU sulla compatibilità elettromagnetica

2014/35/EU sulla bassa tensione

2011/65/EU sulla restrizione dell'uso di sostanze pericolose

2009/125/CE sulla progettazione ecocompatibile



## COLLEGAMENTO ELETTRICO CON SPINA LEGGERE CON ATTENZIONE

Prima di inserire la spina nella presa di corrente verificare attentamente che la tensione della vostra rete domestica corrisponda al valore in V indicato sulla targa caratteristiche dell'apparecchio e che la presa di corrente e la linea di alimentazione siano correttamente dimensionate rispetto alla potenza del dispositivo (anch'essa indicata sulla targa caratteristiche).

Assicurarsi che la linea di alimentazione sia dotata di un dispositivo che permetta il sezionamento dell'apparecchio dalla rete domestica, secondo la normativa vigente.

È obbligatorio che la linea elettrica sia dotata di un dispositivo di protezione differenziale ad alta sensibilità con corrente nominale differenziale di intervento non superiore a 30 mA.

Tutti i riferimenti presenti nel libretto relativi all'utilizzo del modo "Filo Pilota" (Fil Pilote) e alle relative connessioni sono da ignorare in quanto l'apparecchio è sprovvisto di questo modo di funzionamento.

QUESTO APPARECCHIO È CONFORME ANCHE ALLA DIRETTIVA EUROPEA 2009/125/CE  
E AL RELATIVO REGOLAMENTO (UE) 2015/1188.

## Informazioni obbligatorie per gli apparecchi per il riscaldamento d'ambiente locale elettrici.

Identificativo del modello: (vedi etichetta caratteristiche sul prodotto)

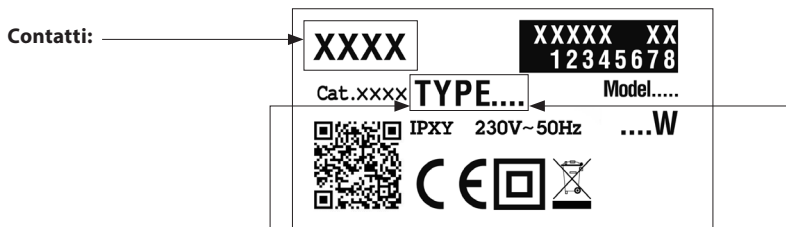

POTENZA TERMICA	TYPE	VALORE	UNITÀ
Potenza termica nominale ( $P_{nom}$ )	xTRxx07x	0,7	kW
	xTRxx10x	1,0	
	xTRxx15x	1,5	
	xTRxx20x	2,0	
Potenza termica minima (indicativa) ( $P_{min}$ )	xTRxx07x	0,0	kW
	xTRxx10x		
	xTRxx15x		
	xTRxx20x		
Massima potenza termica continua ( $P_{max,c}$ )	xTRxx07x	0,7	kW
	xTRxx10x	1,0	
	xTRxx15x	1,5	
	xTRxx20x	2,0	

CONSUMO AUSILIARIO DI ELETTRICITÀ	TYPE	VALORE	UNITÀ
Alla potenza termica nominale ( $e_{l,max}$ )	xTRxx07x	0,000	kW
	xTRxx10x		
	xTRxx15x		
	xTRxx20x		
Alla potenza termica minima ( $e_{l,min}$ )	xTRxx07x	0,000	kW
	xTRxx10x		
	xTRxx15x		
	xTRxx20x		
In modo standby ( $e_{l,SB}$ )	xTRxx07x	0,000	kW
	xTRxx10x		
	xTRxx15x		
	xTRxx20x		

### Tipo di potenza termica/controllo della temperatura ambiente

- potenza termica a fase unica senza controllo della temperatura ambiente [ NO ]
- due o più fasi manuali senza controllo della temperatura ambiente [ NO ]
- con controllo della temperatura ambiente tramite termostato meccanico [ NO ]
- con controllo elettronico della temperatura ambiente [ NO ]
- con controllo elettronico della temperatura ambiente e temporizzatore giornaliero [ NO ]
- con controllo elettronico della temperatura ambiente e temporizzatore settimanale [ SI ]

### Altre opzioni di controllo

- controllo della temperatura ambiente con rilevamento di presenza [ SI ]
- controllo della temperatura ambiente con rilevamento di finestre aperte [ SI ]
- con opzione di controllo a distanza [ NO ]
- con controllo di avviamento adattabile [ SI ]
- con limitazione del tempo di funzionamento [ NO ]
- con termometro a globo nero [ NO ]

## SYMBOLS USED IN THE MANUAL



IMPORTANT!  
DANGER FOR THE SAFETY OF PERSONS, PETS AND THINGS.



IMPORTANT!  
DANGER OF ELECTRIC SHOCK.



IMPORTANT!  
DANGER OF DAMAGE TO THE APPLIANCE.



IMPORTANT!  
HIGH TEMPERATURES. RISK OF BURNS.



TIPS FOR EFFICIENT OPERATION.



DO NOT COVER THE APPLIANCE!

## WARNING



**CAUTION: Some parts of this product can become very hot and cause burns. Particular attention has to be given where children and vulnerable people are present.**



Children of less than 3 years should be kept away unless continuously supervised.

Children aged from 3 years and less than 8 years shall only switch on/off the appliance provided that it has been placed or installed in its intended normal operating position and they have been given supervision or instruction concerning use of the appliance in a safe way and understand the hazards involved.

Children between 3 and 8 years old must not disconnect, regulate and clean the appliance or perform user maintenance.

This appliance can be used by children aged from 8 years and above and persons with reduced physical, sensory or mental capabilities or lack of experience and knowledge if they have been given supervision or instruction concerning use of the appliance in a safe way and understand the hazards involved. Children shall not play with the appliance. Cleaning and user maintenance shall not be made by children without supervision.



Never install the appliance:

- immediately below or in front of a power socket or a junction box (Fig. 5)
- in contact with the wall or floor
- near curtains, flammable or combustible materials or pressure vessels.



**WARNING:**  
Respect the distances shown in figures 3,4.



Install and use the appliance as described in these instructions only.



If the supply cord is damaged, it must be replaced by the manufacturer, its service agent or similarly qualified persons in order to avoid hazard. Never use the appliance if the electronic controls are damaged.



Make sure the fixed power line is fitted with a disconnecting switch allowing the appliance to be disconnected completely from the household mains, included the Pilot Wire, when present, in accordance with the wiring rules.



**WARNING: to avoid hazardous overheating, never under any circumstances cover the appliance (Fig.7). Never obstruct the air flow by inserting material into the appliance.**



Make sure that the power supply line is fitted with a sectioning switch to isolate the appliance, and the control wire if fitted, from the electricity mains according to the regulations in force. The installation must include a multi-pole circuit breaker with a contact opening distance of at least 3 mm.

## 1. SPECIFICATIONS OF THE APPLIANCE

Voltage: 230 V~ 50 Hz

Insulation class: II 

Protection class: IP24

Power [W]	Length [cm]	Height [cm]	Weight [kg]	Rated current [A]
700	47	58	15,5	3
1000	54	58	17,8	4,3
1500	82	58	23	6,5
2000	103	58	30,5	8,6

Table 1



The technical specifications of the appliance are indicated on the rating plate on the side of the radiator (Fig. 1).

A Brand/Manufacturer	F Double insulation
B Model, type, category	G Disposal procedures
C Bidimensional Code (QR)	H Quality marks
D Protection class	I Voltage and Power
E CE marking	L Serial number

## 2. GENERAL INFORMATION



Unpack the appliance carefully and rest it on the polystyrene corner pieces or a carpet.

The package contains:

- the appliance
- mounting kit
- instructions



Read all the instructions carefully before installation and use. Keep for future consultation.



Install and use the appliance as described in these instructions only.



These instructions do not cover all situations which might arise. Caution and common sense should be applied when installing, operating and servicing the appliance.



Modifying the characteristics of the appliance and removing any fixed component including the caps is expressly prohibited. Make sure the appliance is complete and undamaged. If damaged, do not use the appliance, but contact your local dealer or a qualified professional.



The materials used for packaging can be recycled. You are therefore recommended to dispose of them in special differentiated waste collection containers.

## 3. POSITIONING AND INSTALLING



The appliance is designed to heat domestic rooms or similar. It must not be used for other purposes. The appliance must be used permanently mounted on a wall as described in the instructions. Install the appliance with the thermostat at the bottom (Fig. 2).



In bathrooms (with bath or shower), install the appliance outside zone 1.

The appliance must be installed in such a way that the electronic controls and other control devices may not be touched by someone in the bath or shower. The appliance must not be connected with a plug.



**For radiators already fitted with power plugs, see the warnings on page 23.**



Respect the distances shown in figures 3,4.



Never install the appliance:

- immediately below or in front of a power socket or a junction box (Fig. 5)
- in contact with the wall or floor
- near curtains, flammable or combustible materials or pressure vessels.



Make sure there are no pipes or electric wires in the wall which could be damaged while mounting the appliance.



The appliance is equipped with a sensor which can detect an open window, if present above the radiator or within the room. For a proper operation, it is strongly recommended to comply to the installation directions reported in Ch. 4.3.2 before wall mounting.

### 3.1 WALL MOUNTING



Screws and anchors not included



Make sure the screws and anchors are suitable for the type of wall on which you are mounting the appliance. If in doubt, contact a qualified professional or your local dealer.



During installation, make sure the power cable is disconnected from the power line.



Follow the installation sequence shown on the folding leaf of the cover (Scheme 1), respecting the minimum distance between the bottom of the radiator and the floor (Fig. 3).

### 3.2 ELECTRICAL CONNECTIONS



#### WARNING

To be installed by a specialised engineer in accordance with the applicable standards in the country concerned.

When the appliance is installed, make sure the power is off and the mains switch is in the "0" position.



The appliance requires a 230 V ~ 50 Hz power supply. Make sure the power line is appropriate for the data given in table 1.



Make sure the fixed power line is fitted with a disconnecting switch allowing the appliance to be disconnected completely from the household mains, included the Pilot Wire, when present, in accordance with the wiring rules.

If the appliance is installed in a bathroom, the power line must be fitted with a 30 mA RCD (high sensitivity residual current protection device).

The power supply line and Pilot Wire control unit must be protected by the same RCD.

Permanently connected appliances must be connected using a connector block placed within a proper junction box.

When installing the appliance in damp rooms (kitchen, bathroom), the point of connection with the household mains must be at least 25 cm from the floor.

Respect the wiring diagram in figure 8 scrupulously.



**If the Pilot Wire is not connected to the programming unit, it must be terminated and insulated. Under no circumstances should the Pilot Wire be connected to the earth.**



Make sure the power cable cannot in any way come into contact with the surface of the appliance (Fig. 6).

### 4. REGULATION AND OPERATION



The appliance is designed to heat rooms. Some parts of this product can become very hot and cause burns. Particular attention has to be given where children and vulnerable people are present.



GB



Keep combustible or flammable materials or pressure vessels (e.g. spray cans, fire extinguishers) at least 50 cm from the appliance. Do not vaporise any type of substance on the surface of the appliance.



Never touch the appliance with wet or damp hands or feet. Do not wet the electronic control unit with water or other fluids. If this occurs, disconnect the mains power supply and allow the appliance to dry completely.



When the appliance is installed at high altitude, the air will be hotter than the set temperature.



Possible traces of oil noted on the bottom of the radiator during mounting or the first times you turn the appliance on may be left from the fabrication process. Clean the part with proper precautions at intervals of a couple of days. If the problem reoccurs, follow the instructions in Chapter 7.



In cold conditions, the radiator may emit metallic sounds when turned on. This is due to the expansion of the materials.

Fig. 8

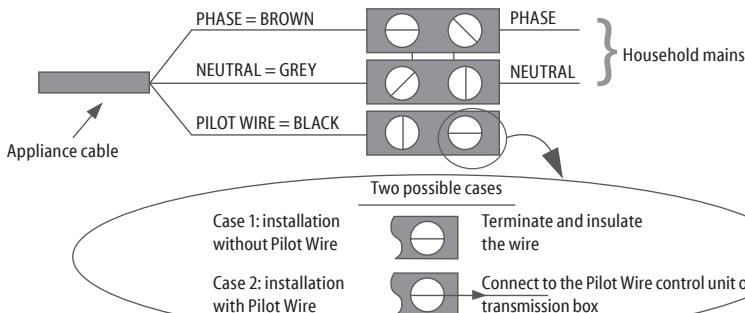

**USING THE RADIATOR FROM THE CONTROL PANEL:**

**GB**

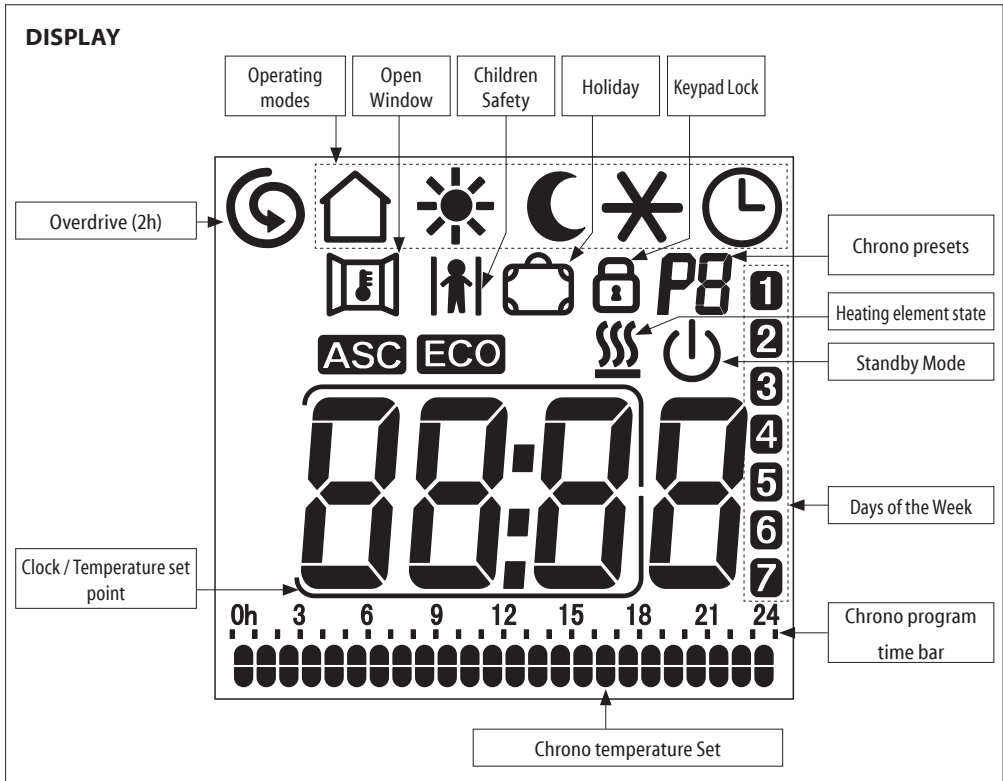
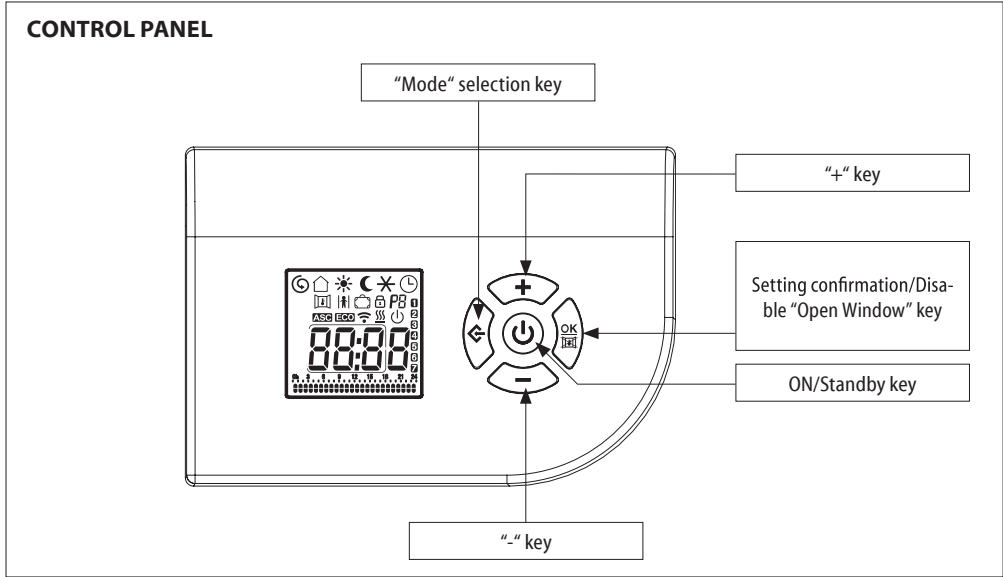



## 4.1 ON/STANDBY MODE



In "Standby" mode the LCD displays the Standby icon , the hour and day of the week. All the operating modes are suspended ("Pilot Wire" included), but the appliance is powered and waiting for command reception.



To turn on or off the appliance, press the "Standby" key. The towel warmer turns on in the previously selected operating mode and emits a beep.

In "Chrono" mode the display shows the time, in the other modes the temperature setting is displayed. The entry into "Standby" mode is signalled by means of a double beep, the exit from "Standby" mode by means of a long beep.

### TURNING ON FOR THE FIRST TIME :







Set the year, month, day of the week and time. Adjust the day of the week by using the "+" and "-" keys (1=MON, 2=TUE, ...7=SUN), then confirm by pressing the "Mode" selection key. The hour starts flashing. In the same way, adjust the hour by using the "+" and "-" keys and confirm with "Mode" selection key. Repeat the same procedure for the minutes. The year of start is 2021.

## 4.2 OPERATING MODES

The appliance provides 6 operating modes which allow the user to heat the environment in the most suitable way with respect to his needs.



Press the "Mode" selection key to select the desired operating mode. An icon on the LCD will show the selected operating mode.

	Pilot Wire		Comfort
	Night/Eco		Anti-Freeze
	Chrono		Energy Saving



### PILOT WIRE

The temperature depends on the "Pilot Wire" command. All "Pilot Wire" commands are enabled.



### COMFORT

The "Comfort" temperature corresponds to the temperature desired by the user. All "Pilot Wire" commands are disabled.



### NIGHT/ECO

The "Night/Eco" mode keeps a comfortable temperature with a reduced energy consumption. All "Pilot Wire" commands are disabled.



### ANTI-FREEZE

In "Anti-Freeze" mode, the temperature set point is fixed at 7 °C. The appliance starts heating automatically when the room temperature drops below 7 °C. All "Pilot Wire" commands are disabled.



### CHRONO

In this mode, you can select one of the three preset chrono-thermostat programs or the custom program. The latter lets you set a daily and weekly program with two temperature levels ("Comfort" and "Night/Eco"). All "Pilot Wire" commands are disabled.



### ENERGY SAVING

This mode reduces the appliance's energy consumption when the room is left unoccupied. Temperature is fixed at 17 °C. All "Pilot Wire" commands are disabled.

When the icon  is displayed on the LCD, the heating element is on.

## 4.2.1 PILOT WIRE

To activate the "Pilot Wire" mode:







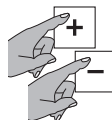

Press the "Mode" selection key until the icon  appears on the LCD.

Users can only set the "Comfort" temperature on the appliance.



Select the desired temperature set point by using the "+" or "-" keys.

The home must be fitted with an automation system supporting this type of technology. In this case, correct transmission of the programming commands can be verified using the following diagram according to the mode set:

Mode	Comfort	Night/Eco (Comfort -3,5°C)	Anti-Freeze	Standby	Comfort -1°C	Comfort -2°C
Signal to be transmitted						
Voltage between Pilot Wire and neutral wires	0 volt	230 volt	115 volt Negative	115 volt Positive	230 volt For an interval of 3 s	230 volt For an interval of 7 s

The icon showing the mode selected on the control unit (Standby, Comfort, Night/Eco, Anti-Freeze) is displayed together with the  icon.

If the Pilot Wire programmer is not connected, "Comfort" operating mode is selected automatically.

### 4.2.2 COMFORT

The "Comfort" temperature set point is the temperature desired by the user.



Press the "Mode" selection key until the icon  appears on the LCD.



Select the desired temperature set point by using the "+" or "-" keys.



The temperature can be chosen in the interval between 7 °C and 32 °C.

### 4.2.3 NIGHT/ECO

In "Night/Eco" mode the temperature set point must not be higher than "Comfort" temperature set point. If the "Comfort" temperature is set below the "Night/Eco" temperature, the latter will be automatically adjusted accordingly.



Press the "Mode" selection key until the icon  appears on the LCD.



Select the desired temperature set point by using the "+" or "-" keys.



The use of this operating mode is recommended in night-time hours and in case no people is in the room for more than 2 hours.

### 4.2.4 ANTI-FREEZE

In "Anti-Freeze" mode the temperature set point is fixed at 7 °C. The appliance starts heating when room temperature goes under 7 °C and with low energy consumption it prevents the room temperature to reach the freezing point.



Press the "Mode" selection key until the icon  appears on the LCD.

This operating mode is recommended when no people is in the room for more than 1 day.

### 4.2.5 CHRONO

In "Chrono" mode, you can select one of the three preset chrono-thermostat programs or the custom program. The latter lets you set various temperatures ("Comfort" and "Night/Eco") over a 24 hour period for each day of the week.

### CHOICE OF PROGRAM



Press the "Mode" key until the icon  is displayed. Then press the "Mode" and "-" keys together and hold them both down for at least 3 seconds.

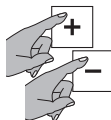

The program code (P1, P2, P3 and P4) flashes. Press the "+" or "-" keys to set the program. Press the "Mode" key to confirm.

The icon of the ASC function (see Ch. 4.3.1) starts flashing. Press the  key to activate the function or the "-" key to de-activate it.

PROGRAM P1	HOURS	MODE
FROM MONDAY TO FRIDAY	0 - 6	Night/Eco
	6 - 9	Comfort
	9 - 16	Night/Eco
	16 - 23	Comfort
SATURDAY AND SUNDAY	23 - 0	Night/Eco
	0 - 7	Night/Eco
	7 - 23	Comfort
	23 - 0	Night/Eco

PROGRAM P2	HOURS	MODE
FROM MONDAY TO SUNDAY	0 - 7	Night/Eco
	7 - 23	Comfort
	23 - 0	Night/Eco

PROGRAM P3	HOURS	MODE
FROM MONDAY TO FRIDAY	0 - 6	Night/Eco
	6 - 9	Comfort
	9 - 13	Night/Eco
	13 - 23	Comfort
SATURDAY AND SUNDAY	23 - 0	Night/Eco
	0 - 7	Night/Eco
	7 - 23	Comfort
	23 - 0	Night/Eco

#### PROGRAM P4 - CUSTOM

With the "P4" program, you can set different temperatures ("Comfort" and "Night/Eco") over a 24 hour period for each day of the week.

## SETTING THE CURRENT DAY AND TIME

Before going on with the P4 custom program setup, check that the hour and day of the week have been correctly set up.



If you fail to enter the setup in this way, press the "Mode" key until the icon appears on the display.

Then press the "Mode" key again and hold it down until the number indicating the day flashes.

- 1
- 2
- 3
- 4

Adjust the day of the week by using the "+" or "-" keys (1=MON, 2=TUE,...7=SUN), then confirm by pressing the "Mode" selection key.

20:30

Repeat the same procedure for the hours.

20:30

The minutes now start flashing. Use the "+" or "-" keys to set the minutes then press the key to confirm and exit or press the "Mode" key to enter the P4 program setup.

## SETTING THE P4 PROGRAM

To enter the P4 custom program setup, press the "MODE" key when you finish setting the minutes (see SETTING THE CURRENT DAY AND TIME).

The time bar will now flash and the clock will show the time being programmed.

Start with the first day. Choose by means of the "+" or "-" keys, for each hour, between the "Comfort" temperature (two lines) and the "Night/Eco" temperature (single line).

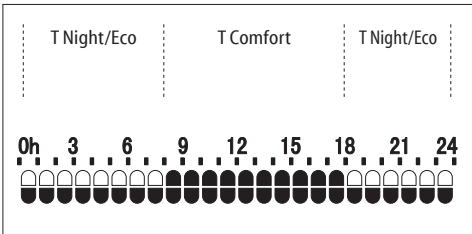

Press the "Mode" key to confirm and repeat the same procedure for each day of the week.

The weekly program is now set.

The icon of the ASC function (see Ch. 4.3.1) starts flashing. Press the key to activate the function or the "-" key to de-activate it.

## 4.2.6 ENERGY SAVING

This fixes the temperature at 17 °C. "Energy Saving" mode reduces energy consumption when the room is left unused but a comfortable temperature needs to be maintained.



To activate "Energy Saving", press the "Mode" key until the "E S" symbol is displayed in place of the hour/temperature.

## 4.3 FUNCTIONS

The appliance has a number of special functions to customise and optimise use.

### 4.3.1 ASC

This function measures the thermal inertia of the room to reach the set temperature and switches the appliance on in advance to ensure that the "Comfort" temperature is reached by the set time.

The function can switch the appliance on up to 2 hours early.



This function can be activated and operates only in "Chrono" mode. (See Ch. 4.2.5.)



A number of days of data acquisition are required to optimise the accuracy of the ASC function.

### 4.3.2 OPEN WINDOW

The "Open Window" function automatically detects an open window in the proximity of the towel warmer (for example during housework) and it goes into "Anti-Freeze mode", in order to prevent unnecessary heating and to save energy. The function can also detect the closing of a window and reset the previous operating condition.

When switching the appliance on, the function is already active, ready to detect any open windows.



To activate or deactivate the function, press the key and hold it down until the icon appears or disappears from the display.



When an open window is detected, the "Open Window" icon flashes.

Now pressing the key cancels the "Open Window" action until detection of the next open window.

The icon stops flashing.

For the optimal operation of the function, it is recommended to install the appliance near a window (Fig. 9).

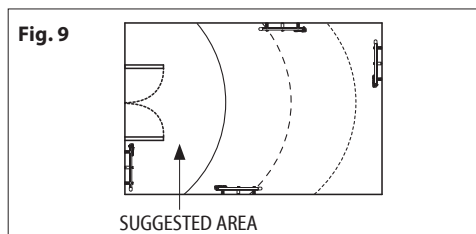

The appliance's reaction to windows opening and closing depends on many factors, such as the temperature set on the appliance, external temperature, the degree of ventilation inside the room, the towel warmer's position and the presence of other heating sources.

The "Open Window" function cannot be activated or deactivated in "Standby" mode.

If the appliance has detected an open window, all the operating modes and the "Overdrive (2h)" function can be selected, however they will not be active until the window is detected as closed or the "Open Window" function is cancelled. The "Children Safety" and "Keypad Lock" functions remain active and can be activated and deactivated even when the appliance has detected an open window.

### 4.3.3 CHILDREN SAFETY

When the "Children Safety" function is activated, the surface temperature of the appliance is lower than in normal operation in the active mode ("Comfort", "Night/Eco",...) to avoid the risk of burns caused by brief accidental contact.

To activate the function, press the "+" and "-" keys together and hold them both down until the icon appears on the display.  
To deactivate the function, repeat the same operation.

"Children Safety" can be activated in all operating modes, including "Overdrive (2h)". The function cannot be activated when the appliance is in "Standby".

#### IMPORTANT:

When this function is active, the appliance heats at reduced power and therefore the room takes longer to warm up.

Even when this function active, children should still be supervised to make sure they are not in danger.

Always avoid prolonged contact between the appliance and the body.

If the appliance is already operating or is still hot after recent use and "Children Safety" is activated, it takes at least two hours for the temperature to drop to the lower value and the function to be operational.

### 4.3.4 OVERDRIVE (2h)

The "Overdrive (2h)" can be used to heat the room quickly.

To activate the function, press the and "+" keys together and hold them both down until the symbol appears on the display.



The minutes left until the end of the two hours are displayed in place of the time.

The appliance heats at the maximum power for 2 hours, independently from the temperature setting.

To deactivate "Overdrive (2h)" function at any time, press the two keys together as before.

After 2 hours since activation, the "Overdrive (2h)" exits automatically and the appliance returns into the previously selected operating mode.

The "Children Safety" function limits the heating power of the appliance even when the function "Overdrive (2h)" is active.

If the appliance has detected an open window, the "Overdrive (2h)" function will not be active until the window is detected as closed or the "Open Window" function is cancelled (see Ch. 4.3.2), however the two-hour countdown continues.

### 4.3.5 HOLIDAY

In case you are out of home for an established number of days, it is possible to set up the appliance so that it stays in "Anti-Freeze" mode during all the period of absence. It will automatically turn on in the previously operating mode as soon as the preset number of days expires.

To activate the function, press the and "-" keys together and hold them both down until the icon appears on the display.

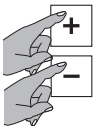

Then set up the desired number of days (maximum 45) by means of the “+” or “-” keys. The desired setting is autoconfirmed.

Now the LCD shows the ☼ icon and the set number of days, which decreases as the days pass.





To deactivate the function at any time, press the  and “-” keys together.

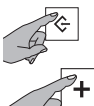

### 4.3.6 KEYPAD LOCK

It is possible to lock the keypad to prevent accidental modifications.



To activate the function, press the “Mode” and “+” keys together and hold them both down until the icon  appears on the display.

To unlock the keypad, press the same two keys together as before.

The “Keypad Lock” icon will no longer appear on the LCD.

**IMPORTANT:** The “Keypad Lock” function does not inhibit the “Standby” key. This is therefore always active, even when the “Keypad Lock” function is enabled.

### 4.4 RESET

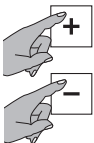

To reset the default settings, in stand-by, press the + and - keys for 4 seconds.

ATT: all the programmes and modifications you have made will be cancelled.

## 4.5 CHANGING THE SET POINT

If the set temperature for normal operation does not correspond to the temperature you perceive in the middle of the room, you can change the compensating settings by  $\pm 5^{\circ}\text{C}$ . For example, if the temperature set on the thermostat is  $24^{\circ}\text{C}$ , but it stops heating the room when you measure just  $22^{\circ}\text{C}$ .



You can correct the setting you read by  $-5^{\circ}\text{C}$ .

You can change the setting in stand-by by pressing and holding the OK and - keys.

**IMPORTANT:** In case of power down due to a black-out, all current settings are kept in memory with the exception of date and time.

If the power black-out occurs in “Chrono” mode, when power is restored, the appliance resumes functioning in “Energy Saving” mode.

**IMPORTANT:** If the appliance remains without power while the “Overdrive (2h)” function is enabled, the date and time settings are lost. When power is restored, the appliance exits the function and resumes functioning in the mode selected previously.

**IMPORTANT:** In case of power down while the “Holiday” function is enabled, when restored, the function remains active and the countdown of days to the end of the holiday resumes from the moment of its stop.

**IMPORTANT:** In case of power down while the “ASC” function is enabled, when restored, the function remains active but a few days will be required for it to become fully operational.

## 5. CLEANING



Before cleaning, make sure the appliance is turned off, cold and disconnected from the household mains.



To clean, just wipe with a soft damp cloth and neutral detergent. Never use abrasive or corrosive cleaning products or solvents.



To maintain efficiency, remove the dust from the surface and inside of the appliance at least twice a year using a vacuum cleaner.

## 6. MAINTENANCE



Should any technical problems arise, contact a qualified professional (recognised or authorised by the dealer or manufacturer) or your local dealer.



All operations on the appliance must be carried out by a qualified professional who before performing maintenance must make sure the appliance is turned off, cold and disconnected from the household mains.

GB

## 7. TROUBLESHOOTING

The appliance does not heat up.	<ul style="list-style-type: none"> <li>• Check if the appliance is correctly connected to the mains power grid and powered.</li> <li>• Check the position of the mains switch of the installation.</li> <li>• Increase the temperature set point on the appliance regulator.</li> <li>• Make sure there are no garments covering the control device or temperature sensor.</li> <li>• If it still does not heat up, contact your local dealer or a qualified professional.</li> </ul>
The appliance heats continuously.	<ul style="list-style-type: none"> <li>• Reduce the temperature set point on the appliance regulator.</li> <li>• Make sure the "Overdrive (2h)" function has not been activated accidentally.</li> <li>• Make sure there are no garments covering the control device or temperature sensor.</li> <li>• If it continues to heat, contact your local dealer or a qualified professional.</li> </ul>
The room stays cold.	<ul style="list-style-type: none"> <li>• Make sure the power of the appliance is adequate for the room to be heated.</li> <li>• If the appliance is being used for the first time, the room takes at least a couple of hours to heat to the required temperature (setting the radiator to maximum does not raise the temperature more quickly).</li> </ul>
The appliance does not cool down.	<ul style="list-style-type: none"> <li>• The heating element requires a few dozen minutes to cool down. Wait the necessary time.</li> </ul>
The appliance does not respond correctly to orders received from the Pilot Wire control unit.	<ul style="list-style-type: none"> <li>• Disconnect the appliance from the mains power supply (switch off the mains switch by moving it in the "0" position). Make sure the connection is correct (Fig.8) and the control unit is functioning correctly.</li> <li>• Contact a qualified professional.</li> </ul>
The appliance keeps on heating despite the window is open and the "Open Window" function is active.	<ul style="list-style-type: none"> <li>• It may be necessary to wait a few minutes before the function starts operating.</li> <li>• The difference between the outside and inside temperature may not be sufficient to activate the function.</li> <li>• Check that the positioning of the appliance comply with the requirements referred to in ch. 4.3.2 of this booklet.</li> <li>• Check that the area around the appliance Command is free of any obstacles.</li> <li>• If the problem persists, contact your dealer or qualified personnel.</li> </ul>
The appliance does not resume heating after the window is closed and the "Open Window" function is active.	<ul style="list-style-type: none"> <li>• It may be necessary to wait a few minutes before before the sensor detects the window closing.</li> <li>• Check that the area around the appliance Command is free of any obstacles.</li> <li>• Deactivate and activate the function again.</li> <li>• Should the response time of the function be too long, you can always start the appliance manually.</li> <li>• If the problem persists, contact your dealer or qualified personnel.</li> </ul>
The display shows "ALL".	<ul style="list-style-type: none"> <li>• The temperature sensor is malfunctioning. Turn off the appliance and contact your dealer.</li> </ul>

## 8. GUARANTEE



You are recommended to keep all parts of the packaging in case the appliance needs to be returned to the dealer. The appliance must arrive complete and undamaged in order to maintain the validity of the guarantee.

The Manufacturer guarantees customers all the rights specified in European Directive 1999/44/EC and the consumer rights recognised by national legislation.

The guarantee specifically covers all non-conformities and production defects present at the moment of sale or becoming evident within two years from the date of purchase and gives the customer the right to free repair of the defective product or replacement should repair be impossible.

The above rights are invalidated in the following cases:

- defects caused by uses other than those specified in the instructions, which are an integral part of the sales contract;
- defects caused by accidental breakage, negligence or tampering.

Operations involved in installation, connection to the household mains and maintenance described in these instructions are not covered by the guarantee.

The Manufacturer declines all liability for damage or injury caused directly or indirectly to people, objects or pets as a result of the failure to apply these instructions, with particular reference to warnings regarding installation, start-up and use of the product.

To claim the above rights, the Customer must contact his/her dealer and present a valid proof of purchase issued by the seller, complete with date of purchase.

## 9. DISPOSAL



Make sure the power cable is disconnected from the power line before performing any operation. To remove the appliance, follow the procedure for fixing to the wall in reverse (Page. 193).

Disposal of this appliance and the fluid contained inside the towel warmer must be carried out in accordance with the legislation in force for the disposal and management of waste.



**Important information for correct disposal of the product in accordance with EC Directive 2012/19/EC.**

At the end of its working life, the product must not be disposed of as urban waste.

It must be taken to a special local authority differentiated waste collection centre or to a dealer providing this service.



This appliance complies with European Directives:

- 2014/30/EU on electromagnetic compatibility
- 2014/35/EU on low voltage
- 2011/65/EU on restriction of the use of certain hazardous substances
- 2009/125/EC on ecodesign requirements



### **ELECTRICAL CONNECTIONS WITH PLUG READ CAREFULLY**

Before plugging into the mains socket, make sure that the voltage of your mains power supply matches the V value reported on the rating plate of the appliance and that the socket and power line are appropriate for the required load (also reported on the rating plate).

Make sure that the power line is fitted with a disconnecting switch allowing the appliance to be disconnected completely from the household mains, in accordance with the regulation in force.

The power line must be fitted at least with a 30 mA RCD (high sensitivity residual current protection device).

All the references about the "Pilot Wire" (Fil Pilote) mode and related wiring present in the instruction manual must be ignored, since operating mode is not available on this product.

## Information requirements for electric local space heaters

GB

Model identifier(s): (see the rating plate on the product)

Contact details:

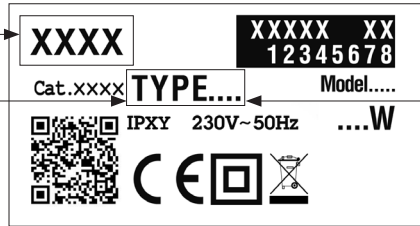

HEAT OUTPUT	TYPE	VALUE	UNIT
Nominal heat output ( $P_{nom}$ )	xTRxx07x	0,7	kW
	xTRxx10x	1,0	
	xTRxx15x	1,5	
	xTRxx20x	2,0	
Minimum heat output (indicative) ( $P_{min}$ )	xTRxx07x	0,0	kW
	xTRxx10x		
	xTRxx15x		
	xTRxx20x		
Maximum continuous heat output ( $P_{max,c}$ )	xTRxx07x	0,7	kW
	xTRxx10x	1,0	
	xTRxx15x	1,5	
	xTRxx20x	2,0	

AUXILIARY POWER CONSUMPTION	TYPE	VALUE	UNIT
At nominal heat output ( $e_{l,max}$ )	xTRxx07x	0,000	kW
	xTRxx10x		
	xTRxx15x		
	xTRxx20x		
At minimum heat output ( $e_{l,min}$ )	xTRxx07x	0,000	kW
	xTRxx10x		
	xTRxx15x		
	xTRxx20x		
In standby mode ( $e_{l,ss}$ )	xTRxx07x	0,000	kW
	xTRxx10x		
	xTRxx15x		
	xTRxx20x		

### Type of heat output/room temperature control

- single stage heat output, no room temperature control [ NO ]
- two or more manual stages, no room temperature control [ NO ]
- with mechanic thermostat room temperature control [ NO ]
- with electronic room temperature control [ NO ]
- electronic room temperature control plus day timer [ NO ]
- electronic room temperature control plus week timer [ YES ]

### Other control options

- room temperature control, with presence detection [ YES ]
- room temperature control, with open window detection [ YES ]
- with distance control option [ NO ]
- with adaptive start control [ YES ]
- with working time limitation [ NO ]
- with black bulb sensor [ NO ]



## PICTOGRAMMES UTILISÉS DANS CETTE NOTICE



ATTENTION!  
DANGER POUR LA SÉCURITÉ DES PERSONNES, DES ANIMAUX DOMESTIQUES ET DES BIENS.



ATTENTION!  
DANGER DE DÉCHARGES ÉLECTRIQUES.



ATTENTION!  
DANGER DE DOMMAGES AU PRODUIT.



ATTENTION!  
TEMPÉRATURES ÉLEVÉES.  
RISQUE DE BRÛLURE.



CONSEIL POUR LE BON  
FONCTIONNEMENT.



NE PAS COUVRIR!

FR

## MISE EN GARDE



**ATTENTION - Certaines parties de l'appareil peuvent devenir très chaudes et provoquer des brûlures. Faire preuve d'une attention particulière en présence d'enfants ou de personnes vulnérables.**



Il convient de maintenir à distance de cet appareil les enfants de moins de 3 ans, à moins qu'ils ne soient sous une surveillance continue.

Les enfants entre 3 et 8 ans doivent exclusivement pouvoir allumer/éteindre l'appareil, à condition que ce dernier soit installé dans sa position de fonctionnement normale et que les enfants soient surveillés ou familiarisés avec le fonctionnement et les risques liés à l'utilisation de l'appareil.

Les enfants entre 3 et 8 ans ne doivent pas régler, nettoyer ni effectuer les opérations d'entretien de l'appareil.

Cet appareil peut être utilisé par des enfants âgés d'au moins 8 ans et par des personnes ayant des capacités physiques, sensorielles ou mentales réduites ou ne disposant pas de l'expérience ou des connaissances nécessaires, à condition de les surveiller ou qu'elles aient reçues les instructions concernant l'utilisation sûre de l'appareil et qu'elles aient compris les dangers inhérents à celui-ci. Les enfants ne doivent pas jouer avec l'appareil. Le nettoyage et l'entretien à la charge de l'utilisateur ne peuvent pas être effectués par des enfants, sauf s'ils sont surveillés.



Ne pas installer l'appareil:

- juste en dessous ou devant une prise de courant ou une boîte de dérivation (Fig. 5)
- en contact avec le mur ou avec le sol
- près de rideaux ou matériaux inflammables ou combustibles ou de récipients sous pression.



**MISE EN GARDE:**

**Respecter les distances indiquées dans les figures 3,4.**



Installer et utiliser l'appareil uniquement comme indiqué dans les instructions.



Si le câble d'alimentation est endommagé, il doit être remplacé par le fabricant, son service après-vente ou des personnes de qualification similaire afin d'éviter un danger. Ne pas utiliser l'appareil si le boîtier électronique est endommagé.



S'assurer que la ligne d'alimentation est munie d'un dispositif de sectionnement permettant d'isoler l'appareil, et le Fil Pilote s'il est présent, du réseau électrique, selon la réglementation en vigueur.



**MISE EN GARDE: Pour éviter une surchauffe, ne pas couvrir l'appareil de chauffage (Fig. 7). En outre, ne pas bloquer le flux d'air, en insérant des matériaux à l'intérieur de l'appareil.**



L'installation doit être munie d'un disjoncteur omnipolaire avec une distance d'ouverture de contact d'au moins 3 mm. L'installation doit être conforme aux normes en vigueur dans le pays d'installation (NFC 15 100 pour la France).

**Les appareils avec prise ne sont pas pour le marché français**

## 1. CARACTÉRISTIQUES DE L'APPAREIL

Voltage: 230 V~ 50 Hz

Classe d'isolation: II 

Degré de protection: IP24

Puissance [W]	Longueur [cm]	Hauteur [cm]	Poids [kg]	Courant nominal [A]
700	47	58	15,5	3
1000	54	58	17,8	4,3
1500	82	58	23	6,5
2000	103	58	30,5	8,6

Tableau 1



Les caractéristiques techniques de l'appareil sont indiquées sur l'étiquette placée sur le côté du radiateur (Fig. 1).

A Marque/Fabricant	F Double isolation
B Modèle, type, catégorie	G Élimination
C Code Bidimensionnel (QR)	H Labels de qualité
D Degré de protection	I Voltage et Puissance
E Marquage CE	L Numéro de série

## 2. INFORMATIONS GÉNÉRALES



Déballer l'appareil et le poser sur les protections en polystyrène ou sur un tapis.

Contenu de l'emballage:

- l'appareil
- kit de fixation
- notice



Lire attentivement la totalité des instructions avant d'installer et d'utiliser l'appareil. Les conserver pour toute future consultation.



Installer et utiliser l'appareil uniquement comme indiqué dans les instructions.



Toutefois cette notice ne couvre pas toutes les situations pouvant se présenter. Faire preuve de bon sens et de prudence lors de l'installation, le fonctionnement et l'entretien de l'appareil.



Il est interdit de modifier de quelque manière que ce soit les caractéristiques de l'appareil et de retirer les parties fixes, quelles qu'elles soient, y compris les bouchons. S'assurer que l'appareil est en bon état. Ne pas utiliser l'appareil s'il est endommagé, mais contacter le vendeur ou un professionnel qualifié.



Les matériaux utilisés pour l'emballage sont recyclables. Il est donc conseillé de les déposer dans les conteneurs de tri sélectif.

## 3. POSITIONNEMENT ET INSTALLATION



Cet appareil a été conçu pour chauffer des pièces et est destiné à un usage domestique ou similaire. Il ne doit pas être destiné à un autre usage.

L'appareil doit être fixé au mur, comme indiqué dans la notice. Installer l'appareil de façon à ce que le thermostat soit placé en bas (Fig. 2).



Dans la salle de bains (équipée d'une baignoire ou d'une douche) installer l'appareil en-dehors de la zone de sécurité 1.

Installer l'appareil de façon à ce que le boîtier électronique et les autres dispositifs de commande ne puissent pas être touchés par une personne se trouvant dans la baignoire ou la douche. Il est interdit d'utiliser une fiche pour le branchement de l'appareil.



### MISE EN GARDE

Respecter les distances indiquées dans les figures 3,4.



Ne pas installer l'appareil:

- juste en dessous ou devant une prise de courant ou une boîte de dérivation (Fig. 5)
- en contact avec le mur ou avec le sol
- près de rideaux ou matériaux inflammables ou combustibles ou de récipients sous pression.



Vérifier qu'il n'y ait pas de tuyaux ou câbles électriques dans le mur qui puissent être endommagés pendant l'installation.



L'appareil est équipé d'un capteur en mesure de détecter l'ouverture d'une fenêtre au-dessus de celui-ci. Pour le bon fonctionnement de la fonction "Fenêtre Ouverte" il est conseillé de vérifier et de suivre les indications indiquées au Chap. 4.3.2 avant de fixer l'appareil au mur.

### 3.1 FIXATION AU MUR



Vis et chevilles non incluses



S'assurer que les vis et les chevilles sont adaptées au type de mur sur lequel l'appareil est installé. En cas de doute s'adresser à un professionnel qualifié ou au vendeur.



Pendant l'installation s'assurer que le câble d'alimentation est déconnecté électriquement.



Procéder à l'installation comme indiqué à l'intérieur du volet de la couverture (Schéma 1) en respectant la distance minimum entre la partie inférieure du radiateur et le sol (Fig. 3).

### 3.2 BRANCHEMENT ÉLECTRIQUE



#### MISE EN GARDE

À faire installer par un professionnel selon la norme d'installation applicable dans chaque pays (NF C15-100 pour la France ou équivalent pour les autres pays).

Avant d'installer l'appareil, s'assurer qu'il n'est pas alimenté électriquement et que l'interrupteur général de l'installation est sur "0".



La tension d'alimentation de l'appareil est de 230 V ~ 50 Hz. S'assurer que la ligne électrique est adaptée à la puissance de l'appareil, indiquée dans le tableau 1.



S'assurer que la ligne d'alimentation est munie d'un dispositif de sectionnement permettant d'isoler l'appareil, et le Fil Pilote s'il est présent, du réseau électrique, selon la réglementation en vigueur.

En cas d'installation dans une salle de bains, la ligne électrique doit être munie d'un dispositif de protection différentiel à haute sensibilité ayant un courant nominal résiduel de 30 mA.

La ligne d'alimentation et le boîtier du Fil Pilote doivent être protégés par le même dispositif de protection différentiel.

Pour le branchement électrique, utiliser une boîte de dérivation.

En cas d'installation dans une pièce humide (cuisine, salle de bain), le branchement de l'appareil au circuit électrique doit se trouver à au moins 25 cm du sol.

Respecter scrupuleusement le schéma de branchement électrique indiqué dans la figure 8.



**Si le Fil Pilote n'est pas raccordé au boîtier de programmation, il faut l'isoler. Le Fil Pilote ne doit jamais être raccordé à la terre.**



S'assurer que le câble d'alimentation ne peut en aucun cas entrer en contact avec la surface de l'appareil (Fig. 6).

### 4. RÉGLAGE ET FONCTIONNEMENT



L'appareil est conçu pour chauffer une pièce. Certaines parties de l'appareil peuvent devenir très chaudes et provoquer des brûlures. Faire preuve d'une attention particulière en présence d'enfants ou de personnes vulnérables.



Maintenir les matériaux combustibles, inflammables et les récipients sous pression (par ex. spray, extincteurs) à au moins 50 cm de l'appareil. Ne vaporiser aucune substance, quelle qu'elle soit, sur la surface de l'appareil.



Ne pas toucher l'appareil avec les mains ou les pieds mouillés ou humides. Veiller à ne pas mouiller la commande électronique avec de l'eau ou d'autres liquides. Si cela se produit, couper le courant et laisser sécher complètement l'appareil.



Lorsque l'appareil est installé en altitude, la température de l'air chauffé est plus élevée.



Les traces d'huile éventuellement remarquées au bas de l'appareil durant le montage ou la première mise en service sont généralement des résidus de fabrication. Nettoyer les traces avec précaution tous les deux jours. Si le phénomène persiste, se conformer aux instructions du Chap. 7.



En cas de mise en service dans des locaux non réchauffés, l'appareil peut émettre des sons métalliques dus à la dilatation des matériaux.

Fig. 8

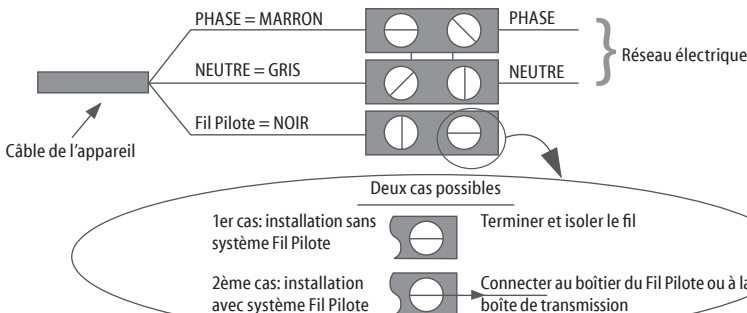

# UTILISATION DU RADIATEUR À L'AIDE DU PANNEAU DE CONTRÔLE:

FR

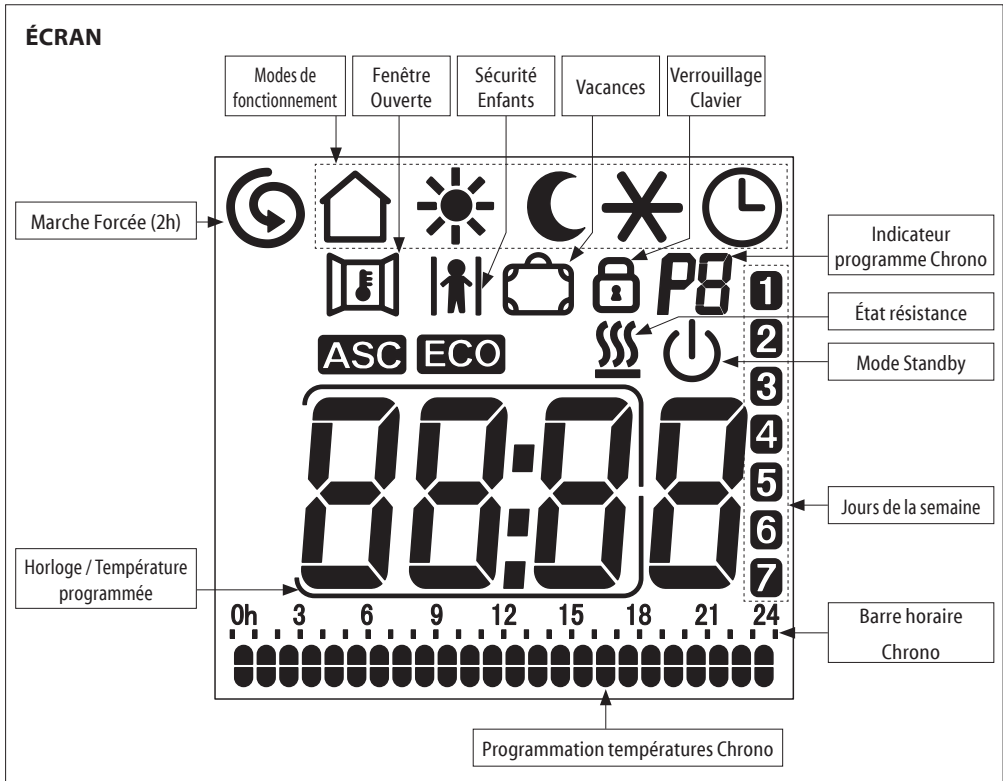
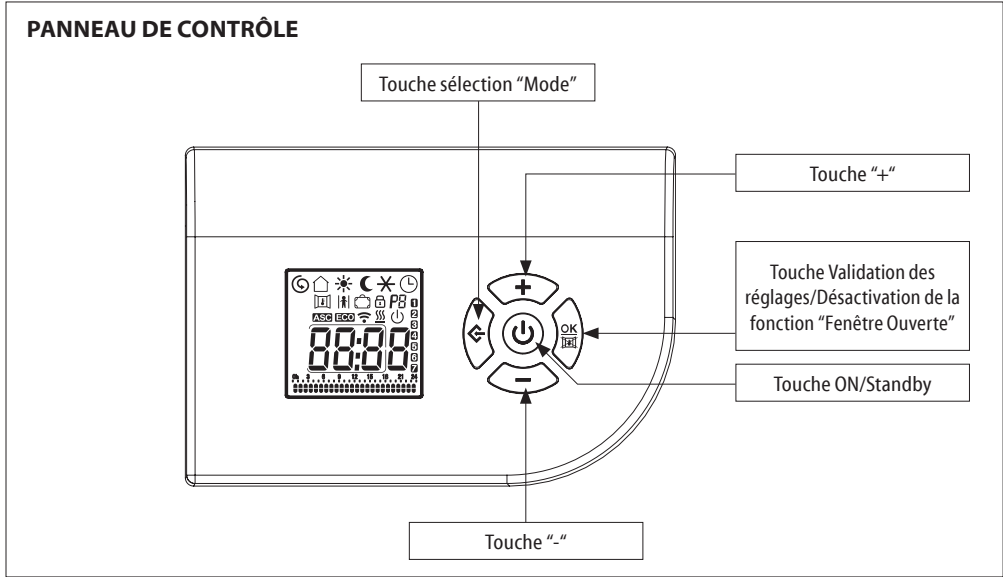

## 4.1 MODE ON/STANDBY



En mode "Standby" l'écran affiche l'icône , l'heure et le jour de la semaine. Tous les modes, y compris le "Fil Pilote" sont désactivés mais l'appareil reste sous tension dans l'attente d'une commande.



Pour allumer ou éteindre l'appareil appuyer sur la touche "Standby". Le sèche-serviettes se met en marche dans le mode de fonctionnement sélectionné avant l'arrêt et émet un signal sonore. L'écran montre l'heure dans le mode "Chrono", la température réglée est montrée dans les autres modes. L'appareil indique par un double signal sonore l'entrée en mode "Standby" et par un signal sonore prolongé la sortie de celui-ci.

### PREMIÈRE MISE EN FONCTION :







Régler le jour de la semaine et l'heure. Régler le jour de la semaine à l'aide des touches « + » et « - » (1=LUN, 2=MAR ... 7=DIM), puis valider en appuyant sur la touche de sélection « Mode ». L'heure commence à clignoter. De la même manière, régler l'heure à l'aide des touches « + » et « - » et valider en appuyant sur la touche de sélection « Mode ». Répéter la même procédure pour les minutes.

## 4.2 MODES DE FONCTIONNEMENT

L'appareil est doté de 6 modes de fonctionnement qui permettent de chauffer la pièce selon ses besoins.



Appuyer sur la touche "Mode" pour choisir le mode de fonctionnement voulu. Une icône sur l'écran indique le mode de fonctionnement:

	Fil Pilote		Confort
	Nuit/Eco		Hors-Gel
	Chrono		Energy Saving



### FIL PILOTE

La température est définie par le "Fil Pilote". Toutes les commandes du "Fil Pilote" sont actives.



### CONFORT

La température de "Confort" correspond à la température souhaitée par l'utilisateur. Toutes les commandes du "Fil Pilote" sont inactives.



### NUIT/ECO

Le mode "Nuit/Eco" maintient une température confortable avec une consommation d'énergie réduite. Toutes les commandes du "Fil Pilote" sont inactives.



### HORS-GEL

En mode "Hors-gel" la température minimale est fixée à 7 °C. L'appareil s'allume automatiquement si la température ambiante descend audessous de 7°C. Toutes les commandes du "Fil Pilote" sont inactives.



### CHRONO

Ce mode permet de sélectionner l'un des trois programmes de thermostat prédéfinis ou le programme personnalisable. Ce dernier permet une programmation journalière et hebdomadaire avec deux niveaux de température ("Confort" et "Nuit/Eco"). Toutes les commandes du "Fil Pilote" sont inactives.



### ENERGY SAVING

Ce mode permet de réduire les consommations, quand la pièce n'est pas occupée. La température est fixée à 17 °C. Toutes les commandes du "Fil Pilote" sont inactives.

Quand le symbole  est affiché sur l'écran la résistance est active.

## 4.2.1 FIL PILOTE

Pour activer le mode "Fil Pilote":





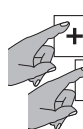



Appuyer sur la touche "Mode" jusqu'à ce que l'icône  soit visible sur l'écran.



L'utilisateur peut uniquement régler la température "Confort" sur l'appareil.

Sélectionner la température désirée à l'aide des touches "+" ou "-".

L'habitation doit être équipée d'un système de gestion qui supporte ce type de technologie. Dans ce cas, pour vérifier la bonne transmission des ordres de programmation, il est possible d'utiliser le schéma suivant, selon le mode programmé:

Mode	Confort	Nuit/Eco (Confort -3,5°C)	Hors-Gel	Standby	Confort -1°C	Confort -2°C
Signal à transmettre						
Tension entre Fil Pilote et neutre	0 volt	230 volt	115 volt Négatif	115 volt Positif	230 volt Pour un intervalle de 3 s	230 volt Pour un intervalle de 7 s

L'icône du mode sélectionné par la centrale (Standby, Confort, Nuit/Eco, Hors-gel) s'affiche sur l'écran à côté de l'icône . Si le Fil Pilote n'est pas relié, le mode "Confort" est automatiquement sélectionné.

### 4.2.2 CONFORT

La température du "Confort" correspond à la température désirée par l'utilisateur.



Appuyer sur la touche "Mode" jusqu'à ce que l'icône  soit visible sur l'écran.

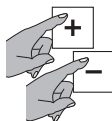

Sélectionner la température désirée à l'aide des touches "+" ou "-".  
L'intervalle de réglage est compris entre 7 °C et 32 °C.

### 4.2.3 NUIT/ECO

En mode "Nuit/Eco", la température programmée doit être égale ou inférieure à la température "Confort". Si vous voulez régler une température "Confort" inférieure à "Nuit/Eco", cette dernière variera donc en conséquence.



Appuyer sur la touche "Mode" jusqu'à ce que l'icône  soit visible sur l'écran.

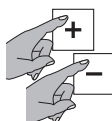

Sélectionner la température désirée à l'aide des touches "+" ou "-".

Il est conseillé d'utiliser ce mode la nuit et quand la pièce n'est pas occupée pendant 2 heures ou plus.

### 4.2.4 HORS-GEL

En mode "Hors-Gel" la température est fixée à 7 °C. L'appareil se met en marche automatiquement lorsque la température ambiante est inférieure à 7 °C et, avec une consommation minimale d'énergie, empêche que la température dans la pièce n'atteigne la température de congélation.



Appuyer sur la touche "Mode" jusqu'à ce que l'icône  soit visible sur l'écran.

Il est conseillé d'utiliser ce mode quand la pièce reste inoccupée pendant un ou plusieurs jours.

### 4.2.5 CHRONO

Le mode "Chrono" permet de sélectionner l'un des trois programmes de chronothermostat prédéfinis ou le programme personnalisable. Ce dernier permet de définir plusieurs températures ("Confort" et "Nuit/Eco") sur une période de 24 h et pour chaque jour de la semaine.

## SÉLECTION DU PROGRAMME



Appuyer sur la touche "Mode" jusqu'à affichage de l'icône . Appuyer ensuite simultanément sur la touche "Mode" et sur la touche "+" pendant 3 sec. minimum.

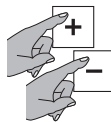

Le numéro qui indique le programme (P1, P2, P3 et P4) clignote: appuyer sur les touches "+" ou "-" pour sélectionner le programme voulu. Appuyer sur la touche "Mode" pour confirmer.

L'icône de la fonction ASC (voir chap. 4.3.1) se met à clignoter, appuyer sur la touche  pour activer la fonction ou sur la touche "-" pour la désactiver.

PROGRAMME P1	HEURES	MODE
DU LUNDI AU VENDREDI	0 - 6	Nuit/Eco
	6 - 9	Confort
	9 - 16	Nuit/Eco
	16 - 23	Confort
SAMEDI ET DIMANCHE	23 - 0	Nuit/Eco
	0 - 7	Nuit/Eco
	7 - 23	Confort
	23 - 0	Nuit/Eco

PROGRAMME P2	HEURES	MODE
DU LUNDI AU DIMANCHE	0 - 7	Nuit/Eco
	7 - 23	Confort
	23 - 0	Nuit/Eco

PROGRAMME P3	HEURES	MODE
DU LUNDI AU VENDREDI	0 - 6	Nuit/Eco
	6 - 9	Confort
	9 - 13	Nuit/Eco
	13 - 23	Confort
SAMEDI ET DIMANCHE	23 - 0	Nuit/Eco
	0 - 7	Nuit/Eco
	7 - 23	Confort
	23 - 0	Nuit/Eco

### PROGRAMME P4 - PERSONNALISÉ

Le programme P4 permet de configurer différentes températures ("Confort" et "Nuit/Eco") sur une période de 24 h et pour chaque jour de la semaine.

## SÉLECTIONNER LE JOUR ET L'HEURE

Avant de configurer le programme personnalisable P4 vérifier que l'heure et le jour de la semaine sont exacts.



Si ce n'est pas le cas, appuyer sur la touche "Mode" jusqu'à ce que l'icône  s'affiche. Puis appuyer de nouveau sur la touche "Mode" en la maintenant enfoncée jusqu'à ce que le nombre qui indique le jour clignote.

1  
2  
3  
4

Appuyer sur les touches "+" ou "-" pour définir le jour de la semaine (1=LUN,2=MAR,... 7=DIM). Appuyer sur la touche "Mode" pour valider.

20:30

Répéter cette même procédure pour régler l'heure.

20:30

Les minutes clignotent, utiliser les touches "+" ou "-" pour les régler et appuyer sur  pour confirmer et quitter ou sur la touche "Mode" pour entrer dans la configuration du programme P4.

## CONFIGURATION DU PROGRAMME P4

Pour paramétrer le programme personnalisé P4 appuyer sur la touche "MODE" à la fin du réglage des minutes (voir RÉGLAGE DE L'HEURE).

La barre horaire se met à clignoter et l'horloge indique l'heure qu'on est en train de programmer.

En partant du premier jour sélectionner la séquence horaire voulue à l'aide des touches "+" ou "-" en choisissant, pour chaque heure, entre la température "Confort" (double cran) et la température "Nuit/Eco" (simple cran).

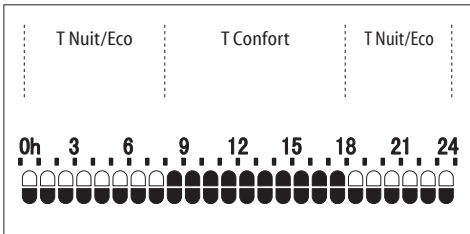

Appuyer sur la touche "Mode" pour confirmer et répéter la procédure pour chaque jour de la semaine. La programmation hebdomadaire est alors réglée.

L'icône de la fonction ASC (voir chap 4.3.1) clignote, appuyer sur la touche  pour activer a fonction ou sur la touche "-" pour la désactiver.

## 4.2.6 ENERGY SAVING

De cette manière la température est fixée à 17 °C. L'Energy Saving permet de réduire les consommations lorsque la pièce n'est pas occupée tout en maintenant une température confortable.



Pour activer l'Energy Saving appuyer sur la touche "Mode", jusqu'à ce que le symbole "E S" s'affiche sur l'écran à la place de l'heure/température.

FR

## 4.3 FONCTIONS

L'appareil est muni de fonctions spéciales qui permettent de personnaliser et d'optimiser l'utilisation de l'appareil.

### 4.3.1 ASC

Cette fonction mesure l'inertie de la pièce pour atteindre la température programmée et avance la mise en marche de l'appareil pour que la température "Confort" soit obtenue à l'heure programmée.

La fonction peut avancer la mise en marche de l'appareil de 2 heures au maximum.



Cette fonction ne peut être activée et n'est opérationnelle qu'en mode "Chrono" (voir Chap. 4.2.5).





Quelques jours d'acquisition des données sont nécessaires pour un fonctionnement optimal de l'ASC.

### 4.3.2 FENÊTRE OUVERTE

La fonction "Fenêtre Ouverte" permet à l'appareil de détecter de façon autonome l'ouverture d'une fenêtre à proximité du sèche-serviettes (par exemple lorsqu'on fait le ménage) et de se mettre en mode "Hors-Gel" afin d'éviter de chauffer inutilement la pièce et donc de gaspiller l'énergie. De la même façon il est en mesure de détecter la fermeture de la fenêtre et de rétablir le mode de fonctionnement précédemment programmé.

Lors de l'allumage de l'appareil la fonction est active, prête à détecter l'ouverture d'une fenêtre.



Pour activer ou désactiver la fonction appuyer sur la touche  et la maintenir enfoncée jusqu'à ce que l'icône  s'affiche ou disparaisse de l'écran.

Quand l'ouverture d'une fenêtre est détectée l'icône "Fenêtre ouverte" clignote.

Il est alors possible, en appuyant sur la touche , d'annuler l'action de "Fenêtre ouverte" jusqu'à ce



qu'une fenêtre ouverte soit de nouveau détectée. L'icône  arrête de clignoter.

Pour assurer une action optimale de la fonction il est conseillé d'installer l'appareil près d'une fenêtre (Fig. 9).

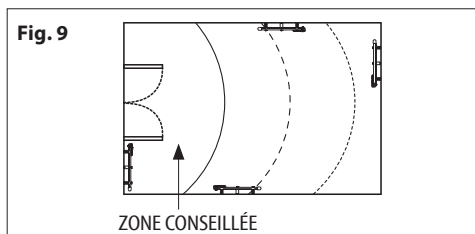

FR



La réponse de l'appareil à l'ouverture et à la fermeture de la fenêtre dépend de différents facteurs comme par exemple la température programmée sur l'appareil, la température extérieure, le degré de ventilation de la pièce où est installé le sèche-serviettes, la position du sèche-serviettes dans la pièce, la présence d'autres sources de chaleur.



La fonction "Fenêtre Ouverte" ne peut pas être activée ou désactivée en mode "Standby".



Si l'appareil a détecté l'ouverture d'une fenêtre tous les modes de fonctionnement et la fonction "Marche Forcée (2h)" peuvent être sélectionnés mais ils ne sont activés que lorsque la fermeture de la fenêtre a été détectée ou que la fonction "Fenêtre ouverte" a été annulée. Les fonctions "Sécurité Enfants" et "Verrouillage Clavier" restent actives et peuvent être activées ou désactivées même quand l'appareil a détecté l'ouverture d'une fenêtre.

### 4.3.3 SÉCURITÉ ENFANTS

Quand on active la fonction "Sécurité Enfants" la température superficielle de l'appareil est réduite par rapport au fonctionnement normal du mode activé ("Confort", "Nuit/Eco",...) de façon à diminuer le risque de brûlures en cas de contact rapide et accidentel.

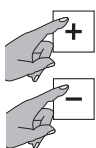

Pour activer la fonction appuyer simultanément sur les touches "+" et "-" en les maintenant enfoncées jusqu'à ce que l'icône  s'affiche sur l'écran.

Effectuer la même opération pour désactiver la fonction.

La "Sécurité Enfants" peut être activée dans tous les modes de fonctionnement et également dans la fonction "Marche Forcée (2h)". La fonction ne peut pas être activée si l'appareil est en "Standby".

### REMARQUES IMPORTANTES:

Cette fonction réduit l'énergie thermique dégagée par l'appareil et le chauffage de la pièce est donc plus lent.

L'utilisation de cette fonction ne dispense pas de surveiller les enfants pour éviter tout risque d'accident.



Éviter dans tous les cas un contact prolongé avec l'appareil.

Si l'appareil est déjà en fonction ou est encore chaud lors de l'activation de la "Sécurité Enfants", deux heures min. sont nécessaires pour l'abaissement de la température et l'opérationnalité de la fonction.

### 4.3.4 MARCHÉ FORCÉE (2h)

La fonction "Marche Forcée (2h)" permet de chauffer rapidement la pièce.



Pour activer la fonction appuyer simultanément sur les touches  et "+" en les maintenant enfoncées jusqu'à ce que le symbole  s'affiche sur l'écran.



Les minutes restantes avant la fin des deux heures sont affichées sur l'écran à la place de l'heure.

L'appareil chauffe pendant deux heures à la puissance maximale en ignorant la programmation de température précédente.

Pour désactiver la fonction "Marche Forcée (2h)", appuyer simultanément sur les deux touches comme précédemment. Deux heures après son activation, la fonction "Marche Forcée (2h)" est automatiquement désactivée et l'appareil revient au mode de fonctionnement précédemment sélectionné.



La fonction "Sécurité Enfants" limite la puissance de l'appareil également lorsque la fonction "Marche Forcée (2h)" est activée.





Si l'appareil a détecté l'ouverture d'une fenêtre la fonction "Marche forcée (2h)" n'est activée que lorsque la fermeture de la fenêtre a été détectée ou que la fonction "Fenêtre ouverte" a été annulée (voir Chap. 4.3.2), toutefois le compte à rebours des deux heures continue.

### 4.3.5 VACANCES

Si on s'absente pendant plusieurs jours il est possible de programmer l'appareil de façon à ce qu'il reste en mode "Hors-Gel" pendant toute la période d'absence et qu'il se remette en marche automatiquement dans le mode précédemment sélectionné à la fin de la durée programmée.



Pour activer la fonction appuyer simultanément sur les touches  et “-” en les maintenant enfoncées jusqu’à ce que l’icône  s’affiche sur l’écran.

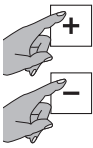

À l’aide des touches “+” ou “-” programmer le nombre de jours (maximum 45 jours).

La programmation voulue est automatiquement confirmée.

L’écran affiche l’icône  et le compte à rebours du nombre de jours restants.

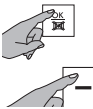

Pour interrompre la fonction à tout moment appuyer simultanément sur les touches  et “-”.

### 4.3.6 VERROUILLAGE CLAVIER

Il est possible de verrouiller le clavier de commande pour éviter toute modification accidentelle.

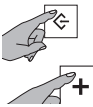

Pour activer la fonction appuyer simultanément sur les touches “Mode” et “+” en les maintenant enfoncées jusqu’à ce que l’icône  s’affiche sur l’écran.

Pour déverrouiller le clavier, appuyer simultanément sur les deux touches comme précédemment.

L’icône “Verrouillage Clavier” n’est plus affichée.

**IMPORTANT:** La fonction “Verrouillage Clavier” ne bloque pas la touche “Standby” qui reste donc toujours fonctionnelle même quand la fonction “Verrouillage Clavier” est activée.

### 4.4 RÉINITIALISATION

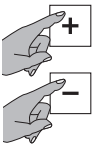

Il est possible de restaurer les réglages d’usine en mode veille en appuyant sur les touches + et - pendant 4 secondes.

**ATTENTION :** tous les programmes et toutes les modifications effectués seront effacés.

### 4.5 MODIFICATION DU POINT DE CONSIGNE

Si la température configurée en régime n’est pas celle perçue au centre de la pièce, il est possible de modifier les paramètres de compensation de  $\pm 5^{\circ}\text{C}$ .

Exemple pratique : si la température réglée sur le thermostat est de  $24^{\circ}\text{C}$  mais que le chauffage de la pièce s’arrête alors que vous ne détectez que  $22^{\circ}\text{C}$ .

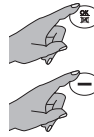

Il est possible de corriger le paramètre lu de  $-5^{\circ}\text{C}$ .

Ce paramètre peut être modifié en mode veille en maintenant la touche OK et -.

**IMPORTANT:** En cas de coupure de courant seul le réglage de la date et de l’heure est perdu, toutes les autres programmations courantes sont conservées.

Si la coupure de courant se produit en mode “Chrono” lorsque le courant est rétabli l’appareil se remet en marche en mode “Energy Saving”.

**IMPORTANT:** En cas de coupure de courant pendant que la fonction “Marche forcée (2h)” est activée, lorsque le courant est rétabli la programmation de la date et de l’heure est perdue et l’appareil quitte la fonction et revient au mode de fonctionnement précédemment sélectionné.

**IMPORTANT:** En cas de coupure de courant pendant que la fonction “Vacances” est activée lorsque le courant est rétabli la fonction reste active et reprend le compte à rebours des jours manquant au moment de l’interruption.

**IMPORTANT:** En cas de coupure de courant pendant que la fonction “ASC” est active lorsque le courant est rétabli la fonction reste active et a besoin de quelques jours pour redevenir pleinement opérationnelle.

### 5. NETTOYAGE



Avant toute opération de nettoyage, s’assurer que l’appareil est éteint et froid.



Pour le nettoyage, il suffit de passer un chiffon humide et doux avec un peu de détergent neutre. Ne pas utiliser de détergents abrasifs, corrosifs ou de solvants.



Pour garantir le bon fonctionnement de l’appareil, éliminer la poussière sur la surface et à l’intérieur de l’appareil au moins deux fois par an à l’aide d’un aspirateur.

## 6. ENTRETIEN



En cas de problèmes techniques, s'adresser à un professionnel qualifié (agréé par le vendeur ou le fabricant) ou contacter le vendeur.



Toute intervention sur l'appareil doit être effectuée par un professionnel qualifié qui, avant toute opération d'entretien, doit s'assurer que l'appareil est éteint, froid et déconnecté électriquement.

FR

## 7. PROBLÈMES ET SOLUTIONS

L'appareil ne chauffe pas.	<ul style="list-style-type: none"><li>• Contrôler qu'il y ait du courant et que l'appareil soit branché correctement.</li><li>• Vérifier la position de l'interrupteur général.</li><li>• Augmenter la température programmée sur le régulateur de l'appareil.</li><li>• Vérifier qu'il n'y ait pas de vêtements qui couvrent le dispositif de commande ou la sonde de température.</li><li>• S'il ne chauffe toujours pas, contacter le vendeur ou un professionnel qualifié.</li></ul>
L'appareil chauffe continuellement.	<ul style="list-style-type: none"><li>• Diminuer la température programmée sur le régulateur de l'appareil.</li><li>• Vérifier que la fonction "Marche Forcée (2h)" n'a pas été activée par inadvertance.</li><li>• Vérifier qu'il n'y ait pas de vêtements qui couvrent le dispositif de commande ou la sonde de température.</li><li>• S'il chauffe encore, contacter le vendeur ou un professionnel qualifié.</li></ul>
La pièce reste froide.	<ul style="list-style-type: none"><li>• Vérifier que la puissance de l'appareil est adaptée à la pièce à chauffer.</li><li>• Lors de première mise en route, il faut environ une paire des heures pour atteindre la température programmée (mettre la régulation au maximum ne fait pas augmenter la température plus vite).</li></ul>
L'appareil ne refroidit pas.	<ul style="list-style-type: none"><li>• Avec ce type de résistance il faut quelques dizaines de minutes à l'appareil pour refroidir. Attendre le temps nécessaire.</li></ul>
L'appareil ne répond pas correctement aux ordres provenant du boîtier Fil Pilote.	<ul style="list-style-type: none"><li>• Déconnecter l'appareil (mettre l'interrupteur général de l'installation sur la position "0"). S'assurer que le branchement est correct (Fig.8) et que le boîtier fonctionne correctement.</li><li>• Contacter un professionnel qualifié.</li></ul>
L'appareil continue à chauffer bien que la fenêtre soit ouverte alors que la fonction "Fenêtre Ouverte" est activée.	<ul style="list-style-type: none"><li>• Quelques minutes peuvent être nécessaires avant que la fonction ne soit active.</li><li>• Il se peut que la différence entre température extérieure et température intérieure ne soit pas suffisante pour rendre la fonction opérationnelle.</li><li>• Vérifier que le positionnement de l'appareil est conforme aux prescriptions indiquées au Chap 4.3.2 de cette notice.</li><li>• Vérifier qu'il n'y ait pas d'obstacles autour de la Commande et de l'appareil.</li><li>• Si le problème persiste contacter le vendeur ou un professionnel qualifié.</li></ul>
L'appareil ne redémarre pas après la fermeture de la fenêtre alors que la fonction "Fenêtre Ouverte" est activée.	<ul style="list-style-type: none"><li>• Quelques minutes peuvent être nécessaires avant que le capteur détecte la fermeture de la fenêtre.</li><li>• Vérifier qu'il n'y ait pas d'obstacles autour de la Commande et de l'appareil.</li><li>• Désactiver et réactiver la fonction.</li><li>• Si le délai de réponse de la fonction est excessif, vous pouvez remettre l'appareil en marche manuellement.</li><li>• Si le problème persiste contacter le vendeur ou un professionnel qualifié.</li></ul>
L'écran paraît un message "ALL".	<ul style="list-style-type: none"><li>• La sonde de température est détériorée. Eteindre l'appareil et contacter votre vendeur.</li></ul>

## 8. GARANTIE



- Si vous avez acheté ce produit en France, en plus de cette garantie commerciale, le vendeur reste tenu de respecter la garantie légale de conformité prévue par les articles L217-4 à L217-14 du Code de la consommation et aux articles qui concernent les vices cachés de la chose vendue dans les conditions prévues aux articles 1641 à 1648 et 2232 du Code civil. Le distributeur auprès duquel vous avez acheté ce produit répond de tout défaut de conformité ou vice caché du produit, conformément aux présentes dispositions.
- En vertu de l'article L217-16 du Code de la consommation, lorsque l'acheteur demande au vendeur, pendant le cours de la garantie commerciale qui lui a été consentie lors de l'acquisition ou de la réparation d'un bien meuble, une remise en état couverte par la garantie, toute période d'immobilisation d'au moins sept jours vient s'ajouter à la durée de la garantie qui reste à courir. Cette période court à compter de la demande d'intervention de l'acheteur ou de la mise à disposition pour réparation du bien en cause, si cette mise à disposition est postérieure à la demande d'intervention. Garantie légale de conformité (extrait du Code de la consommation) : Article L217-4 du Code de la consommation - Le vendeur doit livrer un bien conforme au contrat et répond des défauts de conformité existant lors de la livraison. Il répond également des défauts de conformité résultant de l'emballage, des instructions de montage ou de l'installation lorsque celle-ci a été mise à sa charge par le contrat ou a été réalisée sous sa responsabilité. Article L217-5 du Code de la consommation Le bien est conforme au contrat : 1. S'il est adapté à l'objectif généralement prévu pour des biens similaires et, le cas échéant : s'il correspond à la description donnée par le vendeur et possède les qualités présentées par le vendeur à l'acheteur sous forme d'échantillon ou de modèle ; s'il présente des qualités que l'acheteur peut légitimement attendre au regard des déclarations publiques faites par le vendeur, par le fabricant ou par son représentant, notamment dans la publicité ou l'étiquetage ; 2. Ou s'il présente les caractéristiques définies d'un commun accord par les parties ou est propre à tout usage spécial recherché par l'acheteur, porté à la connaissance du vendeur et que ce dernier a accepté. Article L217-12 du Code de la consommation - Toute réclamation suite à un défaut de conformité est limitée à deux ans à compter de la livraison du bien. Garantie légale sur les vices cachés (extrait du Code de la consommation) : Article 1641 du Code civil - Le vendeur est tenu de la garantie en cas de défauts cachés de la chose vendue qui la rendent impropre à l'usage auquel on la destine, ou qui diminuent tellement cet usage que l'acheteur ne l'aurait pas acquise, ou n'en aurait donné qu'un moindre prix, s'il les avait connus. Article 1648 du Code civil (alinéa 1) - Toute réclamation résultant de vices cachés doit être faite par l'acheteur dans un délai de deux ans à compter de la découverte du vice.

## 9. ÉLIMINATION



S'assurer que le câble d'alimentation est débranché de la ligne électrique avant toute opération. Pour le démontage procéder dans le sens inverse de l'installation (Pag. 193).

Lorsque l'appareil de chauffage est mis au rebut, respecter les réglementations concernant l'élimination du fluide contenu dans le sèche-serviettes et le traitement des déchets.



**Avertissements pour l'élimination correcte du produit aux termes de la Directive européenne 2012/19/EC.**

Au terme de son utilisation, le produit ne doit pas être éliminé avec les déchets urbains.

Le produit doit être remis à l'un des centres de collecte sélective prévus par l'administration communale ou auprès des revendeurs assurant ce service.



Cet appareil est conforme aux Directives européennes:  
 2014/30/EU sur la compatibilité électromagnétique  
 2014/35/EU sur la basse tension  
 2011/65/EU sur la limitation de l'utilisation de certaines substances dangereuses.  
 2009/125/CE sur l'éco-conception



**BRANCHEMENT ELECTRIQUE SUR UNE PRISE  
LIRE ATTENTIVEMENT**

Avant de brancher la fiche dans la prise de courant vérifier soigneusement que la tension du réseau domestique correspond à la valeur en V indiquée sur la plaque des caractéristiques de l'appareil et que la prise de courant et la ligne d'alimentation sont correctement dimensionnées par rapport à la puissance du dispositif (elle aussi indiquée sur la plaque des caractéristiques).

S'assurer que la ligne d'alimentation est dotée d'un dispositif permettant de couper l'alimentation électrique de l'appareil, conformément la réglementation en vigueur.

Il est obligatoire que la ligne d'alimentation électrique soit munie d'un dispositif de protection différentiel à haute sensibilité avec un courant nominal de déclenchement pas supérieur à 30 mA.

Toutes les références présentes dans la notice relative à l'utilisation du mode "Fil Pilote" et aux branchements correspondants sont à ignorer car l'appareil n'est pas muni de ce mode de fonctionnement.

## Exigences d'informations applicables aux dispositifs de chauffage décentralisés électriques

Référence(s) du modèle: (voir étiquette des caractéristiques sur le produit)

FR

Coordonnées de contact:

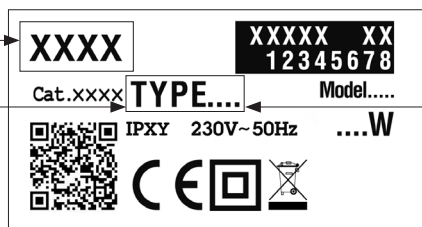

PUISANCE THERMIQUE	TYPE	VALEUR	UNITÉ
Puissance thermique nominale ( $P_{nom}$ )	xTRxx07x	0,7	kW
	xTRxx10x	1,0	
	xTRxx15x	1,5	
	xTRxx20x	2,0	
Puissance thermique minimale (indicative) ( $P_{min}$ )	xTRxx07x	0,0	kW
	xTRxx10x		
	xTRxx15x		
	xTRxx20x		
Puissance thermique maximale continue ( $P_{max,c}$ )	xTRxx07x	0,7	kW
	xTRxx10x	1,0	
	xTRxx15x	1,5	
	xTRxx20x	2,0	

CONSOMMATION AUXILIAIRE D'ELECTRICITE	TYPE	VALEUR	UNITÉ
À la puissance thermique nominale ( $e_{l,max}$ )	xTRxx07x	0,000	kW
	xTRxx10x		
	xTRxx15x		
	xTRxx20x		
À la puissance thermique minimale ( $e_{l,min}$ )	xTRxx07x	0,000	kW
	xTRxx10x		
	xTRxx15x		
	xTRxx20x		
En mode veille ( $e_{l,sp}$ )	xTRxx07x	0,000	kW
	xTRxx10x		
	xTRxx15x		
	xTRxx20x		

### Type de contrôle de la puissance thermique/de la température de la pièce

- contrôle de la puissance thermique à un palier, pas de contrôle de la température de la pièce [ NON ]
- contrôle à deux ou plusieurs paliers manuels, pas de contrôle de la température de la pièce [ NON ]
- contrôle de la température de la pièce avec thermostat mécanique [ NON ]
- contrôle électronique de la température de la pièce [ NON ]
- contrôle électronique de la température de la pièce et programmeur journalier [ NON ]
- contrôle électronique de la température de la pièce et programmeur hebdomadaire [ OUI ]

### Autres options de contrôle

- contrôle de la température de la pièce, avec détecteur de présence [ OUI ]
- contrôle de la température de la pièce, avec détecteur de fenêtre ouverte [ OUI ]
- option contrôle à distance [ NON ]
- contrôle adaptatif de l'activation [ OUI ]
- limitation de la durée d'activation [ NON ]
- capteur à globe noir [ NON ]









Cod. 5725011362/11.21

FTRxxxxF