

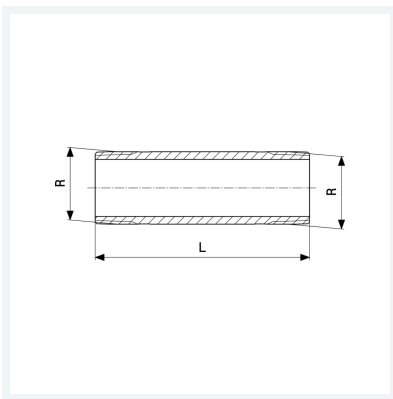

Langnippel
- R-Gewinde
Modell 3530

Artikel 267 315



Eigenschaften

Länge	L	60
Außengewinde kegelig	R	½
Länge	L	60 mm
Gewicht	91,12 g	
Volumen	62,16 cm ³	
Werkstoff	Rotguss oder Siliziumbronze	