

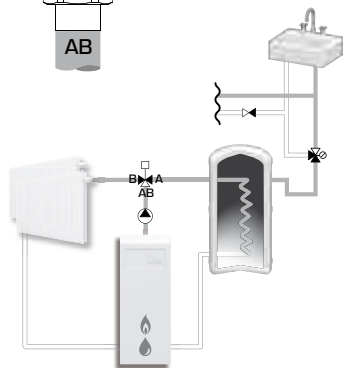

Serie MBA 13x

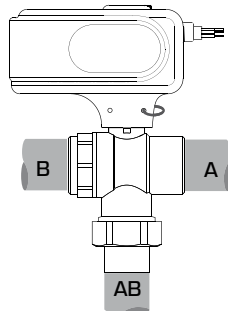

Piping Schematics are General Representations



Mtrl.nr. 98140881 • Ritn.nr 9252 utg B • Rev 1412 Printed in EU



SERIES MBA100



NO.1 IN HYDRONIC SYSTEM CONTROL



Series MBA 12x
Series MBA 13x

CE
LVD 2006/95/EC
EMC 2004/108/EC
RoHS 2011/65/EC

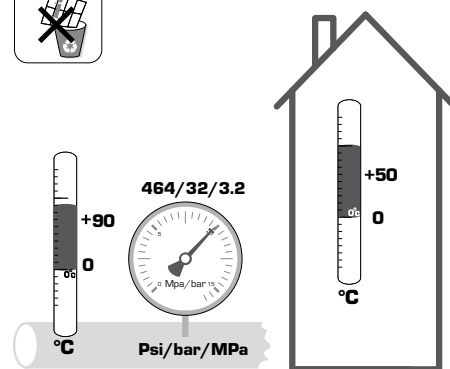

1 IP44 POSITION

RECOMMENDED

NOT GUARANTEED

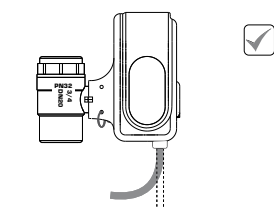
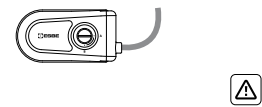
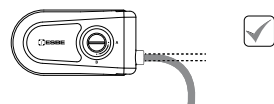
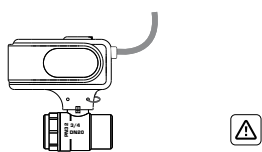
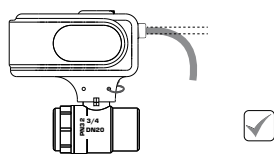

NOT ALLOWED

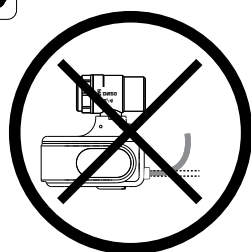

2A Serie MBA 12x

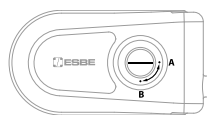

1 ↓



2 ↑

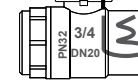

2B Serie MBA 13x

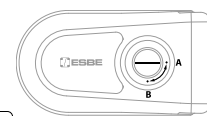

1 ↓

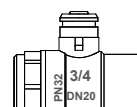

2 ↑

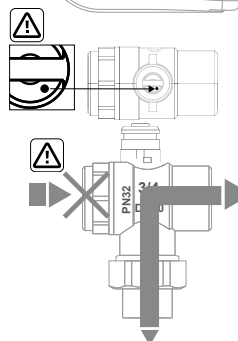

3A

Serie MBA 12x

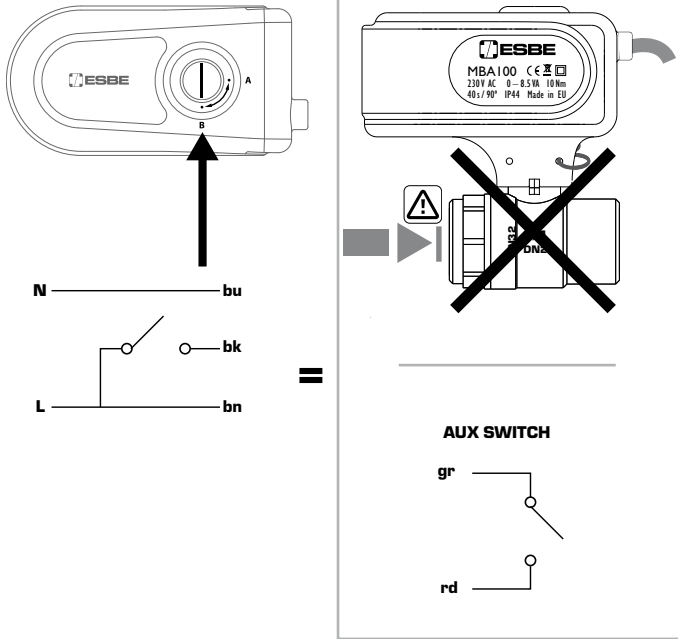
**3B**

Serie MBA 12x

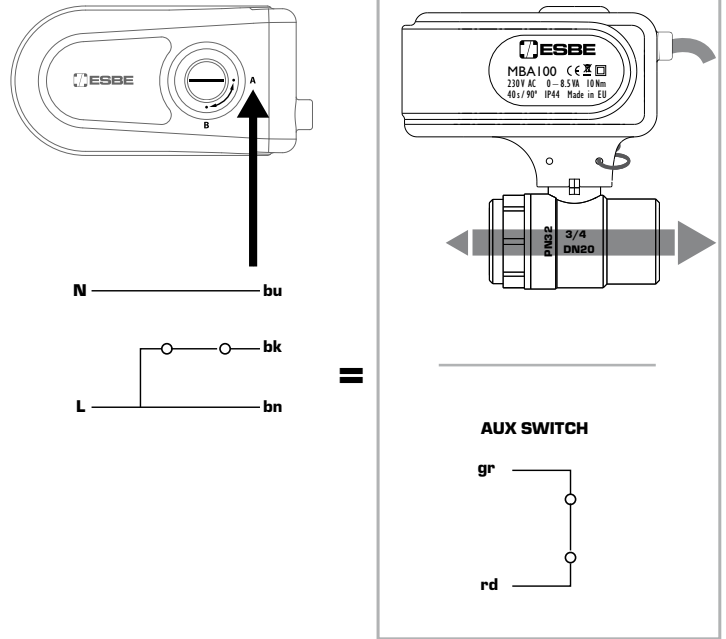
**4A**

Serie MBA 13x

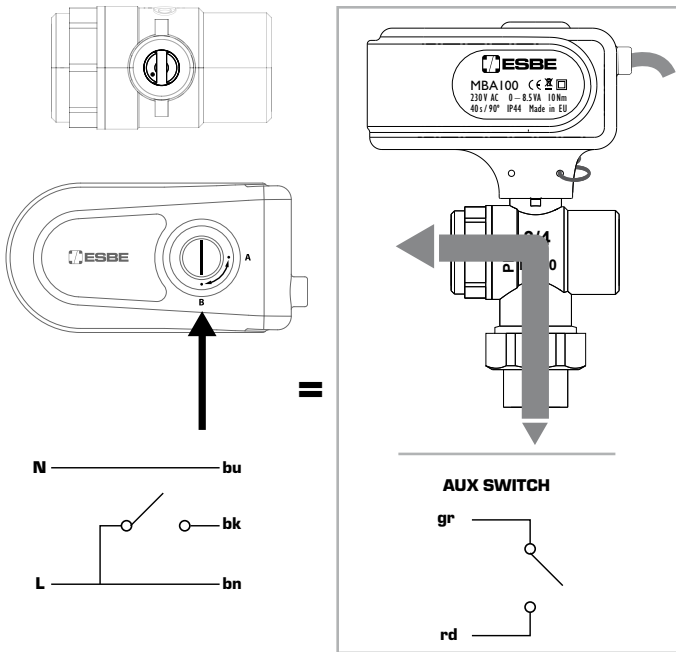
**4B**

Serie MBA 13x

