



ESBE AB  
Bruksgatan 22  
SE-333 75 Reftele  
www.esbe.eu



**SERIES VRG130**



Series VRG131  
Series VRG132  
Series VRG133

Series VRG138  
Series VRG139

PED 2014/68/EU, article 4.3

SI 2016 No. 1105

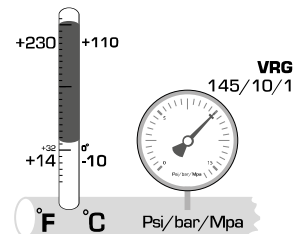
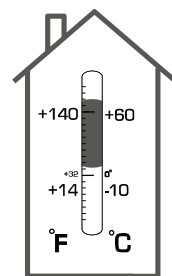

**1**

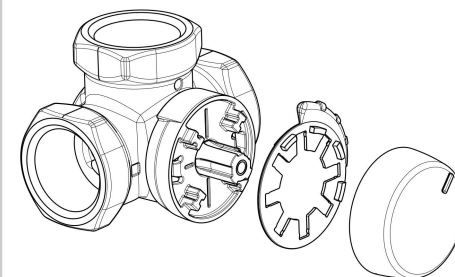

Mtrl.nr. 98140269 • Ritn.nr. 7045 vers. F • Rev. Rev. 2022-04-18

**i**

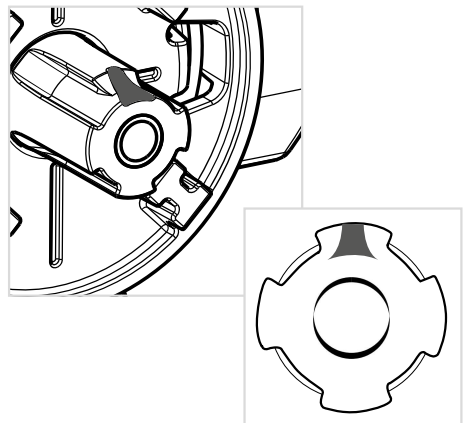

**i**

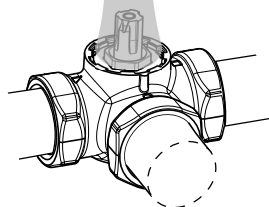
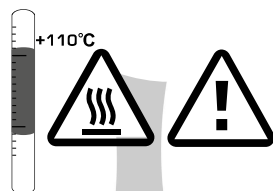
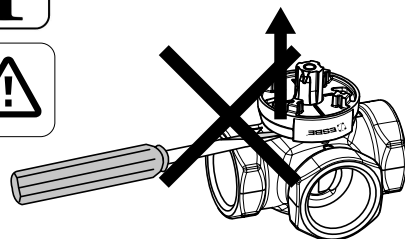

**2**

**a**

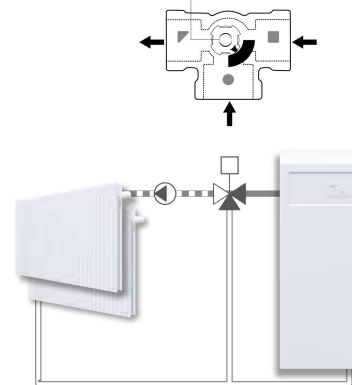

**b**

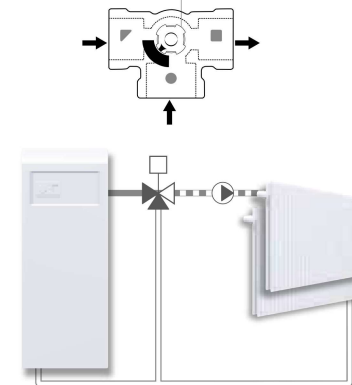
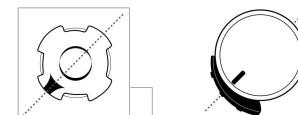

Piping Schematics are General Representations

**3**

**a**

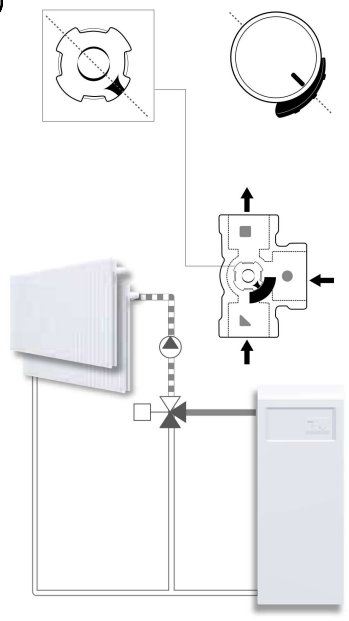

**b**

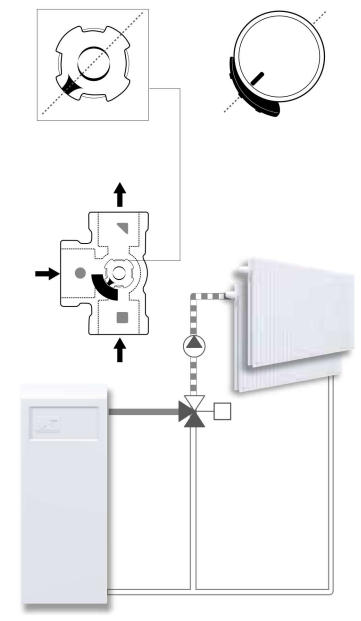

**4**

**a**

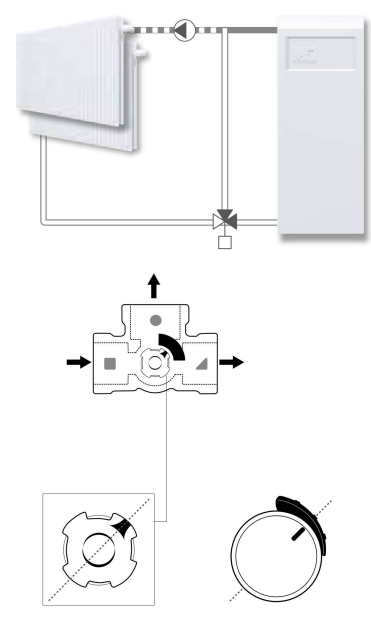

**b**

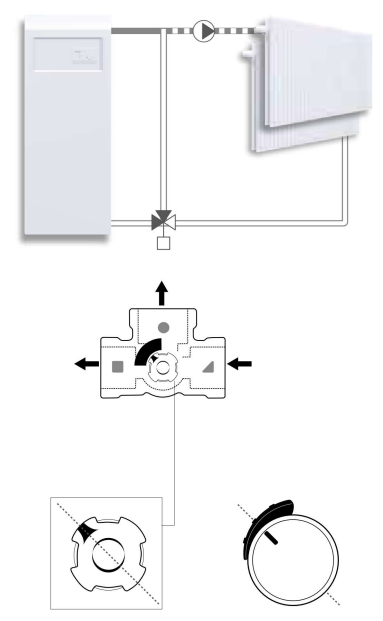

**i**



<http://www.esbe.eu/global/en/products/rotary-valves>