

BENNING

Operating manual

Translation of the German original version

BENNING MM 7-2

5235 / 05/2022 en



Legal notice

Notes concerning the documentation

Ensure that the applicable documentation is used for this product. For safe handling, knowledge that is provided in these instructions is required.

The product may only be handled while following this documentation, particularly the safety instructions and warnings it contains. The personnel must be qualified for the respective task and have the capability to recognise risks and prevent possible dangers.

Manufacturer and holder of rights

BENNING Elektrotechnik und Elektronik GmbH & Co. KG
Münsterstraße 135 – 137
46397 Bocholt
Germany
Phone: +49 2871 / 93-0
E-Mail: duspol@benning.de
Internet: www.benning.de
Commercial register Coesfeld HRA No. 4661

Copyright

© 2022, BENNING Elektrotechnik und Elektronik GmbH & Co. KG

All rights reserved.

This document – particularly all of the contents, texts, photographs and graphics that it contains – are protected by copyright.

No part of this documentation or the associated contents may be reproduced or edited, copied or distributed using electronic media in any form (printed, photocopied or using any other method) without express written permission.

Disclaimer

The contents of the documentation has been checked to ensure that it corresponds to the hardware and software described. Nevertheless, deviations cannot be ruled out, so Benning cannot guarantee complete correspondence. The contents of this documentation are checked at regular intervals, and any corrections that are needed are contained in the versions that follow.

General non-discrimination

Benning is aware of the importance of language with regard to the gender equality and endeavors to take this into account at all times. To improve readability, we have refrained from consistently using differentiating formulations.

Table of contents

1	Introduction	7
1.1	General notes.....	7
1.2	History.....	8
1.3	Service & support.....	9
2	Safety	10
2.1	Warning system.....	10
2.2	Standards applied.....	10
2.3	Symbols used.....	11
2.4	Intended use.....	12
2.5	Special types of risks.....	14
3	Scope of delivery	15
4	Device description	17
4.1	Device structure.....	17
4.2	Functions.....	20
4.2.1	Blue "Function" key.....	20
4.2.2	"MIN MAX" key.....	21
4.2.3	"Hz" key.....	22
4.2.4	"VoltSense" key.....	22
4.2.5	"PEAK" key.....	22
4.2.6	"HOLD" key.....	23
4.2.7	"REL Δ" key.....	23
4.2.8	"RANGE" key.....	24
4.2.9	"AutoV LoZ" function.....	24
4.2.10	Jack control.....	24
4.2.11	Further setting options.....	25
4.3	Measuring ranges.....	26
4.3.1	Voltage ranges.....	26
4.3.2	Current ranges.....	28
4.3.3	Resistance ranges.....	29
4.3.4	Continuity test.....	29
4.3.5	Diode test.....	29
4.3.6	Capacitance ranges.....	30
4.3.7	Frequency ranges.....	30
4.3.8	Temperature ranges.....	31
5	Operation	32
5.1	Requirements for tests and measurements.....	32
5.2	Connecting the safety measuring lines.....	33
5.3	Voltage, frequency or duty cycle measurement.....	34

5.4	Current or frequency measurement	35
5.5	Resistance measurement or continuity testing	36
5.6	Capacitance measurement or diode testing.....	37
5.7	Temperature measurement.....	38
5.8	Voltage indicator	39
5.8.1	Non-contact phase testing	39
5.8.2	External conductor or phase testing.....	41
6	Maintenance	42
6.1	Maintenance schedule	42
6.2	Making the device free of voltage	42
6.3	Cleaning the device.....	43
6.4	Replacing the batteries	44
6.5	Calibrating the device.....	44
6.6	Replacing the fuses.....	45
7	Technical data.....	46
8	Disposal and environmental protection	47
	Index	48

Table of figures

Figure 1	BENNING CFlex 1	15
Figure 2	BENNING TA 1	15
Figure 3	BENNING TA 2	16
Figure 4	BENNING TA 3	16
Figure 5	Ø 4 mm measuring lines with 2 mm measuring probe	16
Figure 6	BENNING MM 7-2 device structure	17
Figure 7	Rotary switch	18
Figure 8	Digital display.....	19
Figure 9	Voltage, frequency or duty cycle measurement.....	34
Figure 10	Current or frequency measurement	35
Figure 11	Resistance measurement or continuity test	36
Figure 12	Capacitance measurement or diode testing	37
Figure 13	Temperature measurement	38
Figure 14	Non-contact phase testing	39
Figure 15	External conductor or phase testing	41
Figure 16	Battery replacement (exemplary).....	44
Figure 17	Fuse replacement (exemplary)	45

List of tables

Table 1	History.....	8
Table 2	Symbols on the device.....	11
Table 3	Symbols used in the operating manual.....	11
Table 4	Selecting a function	20
Table 5	Low-pass filter.....	21
Table 6	Trigger thresholds	22
Table 7	AC voltage ranges (V-AC, V-AC+DC)	26
Table 8	AC voltage ranges (HFR V-AC).....	27
Table 9	DC voltage ranges (V-DC).....	27
Table 10	Voltage ranges (LoZ, AutoV)	27
Table 11	AC ranges (A-AC, A-AC+DC).....	28
Table 12	DC ranges (A-DC).....	28
Table 13	4 - 20 mA DC current loop (%)	28
Table 14	Resistance ranges (Ω).....	29
Table 15	Continuity test	29
Table 16	Diode test.....	29
Table 17	Capacitance ranges (F)	30
Table 18	Mains frequency ranges (Hz).....	30
Table 19	5 V logic-level frequency ranges (Hz).....	30
Table 20	Logic-level duty cycle (%).....	31
Table 21	Temperature ranges ($^{\circ}\text{C}$ / $^{\circ}\text{F}$)	31
Table 22	Maintenance schedule	42
Table 23	Technical data	46

1 Introduction

The TRUE RMS digital multimeter BENNING MM 7-2 described here (in the following only referred to as “device”) is intended for testing in electric circuits with a nominal voltage up to a maximum of 1 000 V-AC or 1 000 V-DC. The device enables you to perform the following tests and measurements:

- DC and AC voltage measurement
- DC and AC current measurement
- Resistance measurement
- Diode and continuity test
- Capacitance measurement
- Frequency and duty cycle measurement
- Temperature measurement

Further information

<http://tms.benning.de/mm7-2>

On the Internet, you will find the following additional information directly at the specified link or at www.benning.de (product search):

- Operating manual of the device in several languages
- Further information depending on the device (e. g. brochures, technical reports, FAQs)

1.1 General notes

Target group

This operating manual is intended for the following groups of people:

- Qualified electricians and electrotechnically trained personnel

Required basic knowledge

To understand these operating manual, you will need general knowledge of testing and measuring equipment. Moreover, you will need basic knowledge of the following issues:

- General electrical engineering

Purpose of the operating manual

This operating manual describes the device and provide you information about how to handle it. Keep this operating manual in a safe place for later use. Read this operating manual before handling the device and follow the instructions.

NOTE

Disclaimer of liability

Please make sure that any person using the device has read and understood the instructions of this operating manual before handling the device and that the instructions are adhered to in all points. Non-observance of this operating manual might result in product damage, property damage and/or personal injury.

Benning assumes no liability for damage and malfunctions resulting from the failure to observe the instructions in this operating manual.

The devices are subject to continuous further development. Benning reserves the right to make changes to the device's design, configuration and technology. The information in this operating manual corresponds to the state of technical knowledge at the time of printing. For this reason, no claims for certain device characteristics can be derived from the contents of this operating manual.

Information in this operating manual can be changed at any time without prior notice. Benning is not obligated to make amendments to this operating manual or to keep it up to date.

Direct any technical questions to Technical Support [▶ page 9].

Trademarks

All trade marks that are used are the property of their respective owners, even if they are not separately marked as such.

1.2 History

Release number	Amendments
05/2022	• Initial release

Table 1: History

1.3 Service & support

Please contact your specialty retailer or the BENNING Service Center for any repair or service work that might be required.

Technical support

Please contact our Technical support for technical questions on handling the device.

Phone:	+49 2871 93-555
Fax:	+49 2871 93-6555
E-Mail:	helpdesk@benning.de
Internet:	www.benning.de

Returns management

Easily and conveniently use the BENNING returns portal for a quick and smooth returns processing:

<https://www.benning.de/service-de/retourenabwicklung.html>

Phone:	+49 2871 93-554
E-Mail:	returns@benning.de

Return address

BENNING Elektrotechnik und Elektronik GmbH & Co. KG
Retourenmanagement
Robert-Bosch-Str. 20
D - 46397 Bocholt

2 Safety

2.1 Warning system

This operating manual contains notes that must be taken into consideration for your personal safety and in order to avoid injuries and damage to property. Warnings about your personal safety and to prevent personal injuries are marked with a warning triangle. Warnings on sole prevention of material damage are shown without a warning triangle. The warnings are shown in descending order depending on the hazard level as follows.



⚠ DANGER

Extremely dangerous situation for humans

If you do not pay attention to this warning, irreversible or deadly injuries will occur.



⚠ WARNING

Hazard to humans

If you do not pay attention to this warning, irreversible or deadly injuries could occur.



⚠ CAUTION

Minor hazard to humans

If you do not pay attention to this warning, minor or moderate injuries could occur.



NOTICE

Danger to property, not to persons

If you do not pay attention to this warning, material damage could occur.

If multiple hazard levels occur, the warning for the highest respective hazard level will be used. In addition, a warning about personal injuries can also include a warning about material damage.

2.2 Standards applied

The device has been built and tested in compliance with the following standards and has left the factory in perfectly safe condition.

- IEC / DIN EN 61010-1 (VDE 0411-1)
- IEC / DIN EN 61010-2-033 (VDE 0411-2-033)
- IEC / DIN EN 61010-031 (VDE 0411-031)

2.3 Symbols used

Symbols on the device











Symbol	Meaning
	Please observe the information provided in this operating manual in order to avoid dangers.
	Warning of electrical danger! Please observe the information provided in this operating manual in order to avoid dangers.
CAT II	Measuring category II is applicable to testing and measuring circuits which are directly connected to user connections (e. g. sockets) of the low-voltage mains installation.
CAT III	Measuring category III is applicable to testing and measuring circuits connected to the distribution circuit of the low-voltage mains installation of a building.
CAT IV	Measuring category IV is applicable to testing and measuring circuits connected to the feeding point of the low-voltage mains installation of a building.
	The device complies with EU directives.
	The device complies with UK directives.
	At the end of product life, dispose of the unserviceable device via appropriate collecting facilities provided in your community.
	The device is provided with protective insulation (protection class II).
	This symbol indicates the inserted batteries.
	Please observe the operating manual.
	(DC) direct voltage or direct current
	(AC) alternating voltage or alternating current
	Earth (voltage to earth)

Table 2: Symbols on the device

Symbols used in the operating manual



Symbol	Meaning
	General warning
	Warning of electric voltage!

Table 3: Symbols used in the operating manual

2.4 Intended use

Only use the device within the framework of the corresponding technical data. Any operating conditions that deviate from this shall be considered as improper use. Solely the user of the device shall be liable for any resulting damage.

In particular, note the following:

- In case of improper use, the liability and warranty claims become void. Solely the user of the device shall be liable for any damage resulting from improper use. Uses not complying with the intended use include e. g.:
 - Use of components, accessories, spare or replacement parts that have not been released and approved for the respective application by Benning
 - Non-observance, manipulation, changes or misuse of the operating manual or the instructions and notes contained therein
 - Any form of misuse of the device
 - Any use other than or beyond that described in this operating manual
- Warranty and liability claims are generally excluded if damage is due to force majeure.
- If any prescribed services are not performed regularly or not on time according to manufacturer specifications during the warranty period, a decision about a warranty claim can only be made once the findings are available.

Direct any questions to Technical Support [▶ page 9].

Using the device

Please observe the following basic obligations when using the device:

- The device may only be used in a technically perfect and safe condition. Always check the device for damages before using it.
- Make sure the personnel using the device is qualified for the respective task.
- Observe relevant regulations on occupational safety and health as well as those on environmental protection.
- The device may only be used inside buildings and in dry environments.
- Do not use the device in potentially explosive environments.
- Use the device only in electric circuits up to overvoltage category CAT III with a conductor for a maximum of 1 000 V or up to overvoltage category CAT IV with a conductor for a maximum of 600 V to earth.
- Use suitable (approved) safety measuring lines. For measurements in electric circuits of overvoltage category CAT III or CAT IV, the protruding conductive part of a contact tip of the safety measuring line must not be longer than 4 mm. Before measuring, attach the enclosed protective caps onto the contact tips (marked with CAT III and CAT IV).
- In order to detect a dangerous voltage and to prevent any danger, always measure a present voltage first without low-pass filter (without high-frequency suppression “HFR”).
- Do not use the “AutoV LoZ” measuring function for voltage measurement on sensitive electronic circuits. The initially low input resistance might briefly generate current peaks of up to 673 mA (1 000 V x 1.414 / 2.1 kΩ).
- In order to prevent any danger due to incorrect measurements, replace discharged batteries immediately.
- In order to prevent any danger, replace a defective fuse immediately.

**⚠ WARNING****Dangerous voltage**

Danger to life or serious injury is possible due to contact with high electric voltage in case of incorrect operation.

- Do not touch the bare measuring probe tips of the safety measuring lines or the bare contacts of the optional alligator clips. Only touch the safety measuring lines in the area intended for your hands.
- Connect the safety measuring lines to the correspondingly marked measuring jacks of the device and check them for tight fit.
- Only use approved safety measuring lines.
- Attach the protective caps to the contact tips of the safety measuring lines (circuits of overvoltage category CAT III or IV).
- When disconnecting the measuring circuit, first remove the live safety measuring line (phase) and then the neutral safety measuring line from the measuring point.

**⚠ WARNING****Opening the device**

Danger to life or serious injury is possible due to contact with high electric voltage when opening the device. The device might get damaged.

- Make sure that the device is free of voltage before opening the battery compartment or housing.
- Do not open the device (except for the battery compartment and replacing a fuse).
- Please contact your specialty retailer or the returns management for any repairs [▶ page 9].

Securing the device

If the device is not in a technically perfect and operationally safe condition, safe operation is no longer guaranteed. Make sure that the following measures are taken:

- Switch off the device.
- Remove the device from the measuring point.
- Secure the device against unintentional operation.

The following characteristics indicate that safe operation is no longer guaranteed:

- The device (housing or safety measuring lines) shows visible damage or is damp/wet.
- The insulation of the safety measuring lines is damaged.
- The device does not work properly in compliance with regulations (e. g. errors during measurements).
- The device shows recognisable consequences of prolonged storage under inadmissible conditions.
- The device shows recognisable consequences of extraordinary stress due to transport.

2.5 Special types of risks



DANGER

Bare conductors or main line carriers

Danger to life or serious injury is possible due to contact with high electric voltage when working with bare conductors or main line carriers.

- Please observe relevant regulations on occupational safety and health.
- If necessary, use appropriate protective equipment.



WARNING

Dangerous voltage

Danger to life or serious injury is possible due to contact with high electric voltage when working on live components or equipment. Even low voltages from 30 V-AC and 60 V-DC on can be dangerous to human life!

- Please observe relevant regulations on occupational safety and health.
- If necessary, use appropriate protective equipment.

3 Scope of delivery

The scope of delivery of the device includes the following components:

- 1 x TRUE RMS digital multimeter BENNING MM 7-2 (item no.: 044690)
- Silicone safety measuring lines (item no.: 10231315):
 - 1 x silicone safety measuring line (red, l = 1.0 m)
 - 1 x silicone safety measuring line (black, l = 1.0 m)
- 1 x wire temperature sensor of type K (l = 93 cm ±3 cm, item no.: 10231316)
- 1 x compact protective pouch (item no.: 010913)
- 3 x 1.5 V micro batteries (AAA / IEC LR03)
- Fuses (integrated into the device for initial assembly):
 - 1 x fuse F1 (F 11 A, 1 000 V, 20 kA)
 - 1 x fuse F2 (F 0.4 A, 1 000 V, 30 kA)
- 1 x operating manual

Optional accessories

- Flexible AC current transformer BENNING CFlex 1 (item no.: 044068)
AC range: 30 A / 300 A / 3 000 A



Figure 1: BENNING CFlex 1

- Set of safety measuring lines BENNING TA 1 (item no.: 044124)
Ø 4 mm alligator clips, 2-piece, red / black, professional version, CAT III 1 000 V, 36 A



Figure 2: BENNING TA 1

- Set of safety measuring lines BENNING TA 2 (item no.: 044125)
Set of Ø 4 mm measuring lines, 6-piece, red / black, professional version, consisting of:
 - Measuring lines (silicone) (CAT III 1 000 V)
 - Test probes (4 mm measuring probe, CAT II 1 000 V)
 - Alligator clips (CAT III 1 000 V)



Figure 3: BENNING TA 2

- Set of safety measuring lines BENNING TA 3 (item no.: 044126)
Set of Ø 4 mm measuring lines, 8-piece, red / black, professional version, CAT III 1 000 V, consisting of:
 - Measuring lines (silicone)
 - Test probes (slender measuring probe)
 - Grabber clips
 - Alligator clips



Figure 4: BENNING TA 3

- Set of Ø 4 mm safety measuring lines with 2 mm measuring probe (item no.: 044146)
Ø 4 mm measuring lines, 2-piece, red / black, l = 1.40 m, with 2 mm measuring probe, CAT IV 600 V / CAT III 1 000 V (with protective caps), CAT II 1 000 V (without protective caps)



Figure 5: Ø 4 mm measuring lines with 2 mm measuring probe

4 Device description

4.1 Device structure



Figure 6: BENNING MM 7-2 device structure

1	Front panel of the device	2	Rear panel of the device
3	Battery compartment	4	Holder for engaging a safety measuring line
5	Foldable stand	6	Jack for V, Ω, diode, capacitance, temperature
7	COM jack	8	Jack for A
9	Jack for μA / mA	10	Rotary switch
11	Function keys	12	Digital display

Rear panel of the device

- Foldable stand
- Battery compartment
The device is powered by three 1.5 V micro batteries (AAA / IEC LR03).
- Holders for engaging the safety measuring lines
You can store the safety measuring lines by wrapping them around the housing and engaging the measuring probes and the gripping areas onto the housing in a protective way.
- 2 labels with notes and information about the device
- Serial number (label)

Rotary switch

You can set the desired test or measurement by means of the rotary switch.

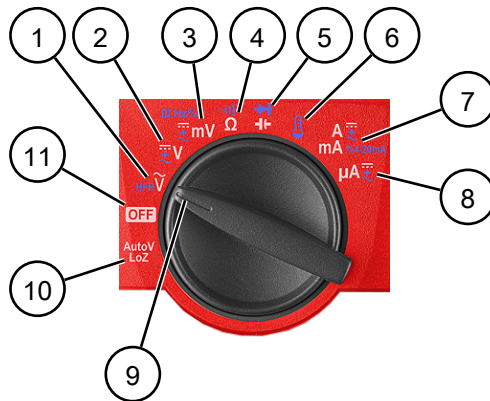

Figure 7: Rotary switch

1	AC voltage measurement (V-AC)	2	Voltage measurement (V)
3	Voltage (mV), frequency or duty cycle measurement	4	Resistance measurement (Ω) or continuity test
5	Capacitance measurement or diode test	6	Temperature measurement
7	Current measurement (A / mA)	8	Current measurement (μA)
9	Setting of the rotary switch	10	Voltage measurement (AutoV LoZ)
11	Device switched off (OFF)		

Digital display

The digital display is divided into different sections:

- Display of the currently set functions and units
- Display range: 5-digit liquid crystal display (LCD) with a font size of 15 mm and decimal points. The highest display value is 60 000 digits.
- Bargraph indication with 30 segments
- Battery status: Indicates the empty state of charge of the batteries. When the symbol appears, the batteries are discharged.
- Polarity display (automatic): Indicates a polarity contrary to the jack definition with “-”.

The maximum nominal measuring rate of the device is 5 measurements per second for the digital display and 50 measurements per second for the bargraph indication. For reading the values in dark lighting conditions, the digital display is provided with a background lighting [► page 21].

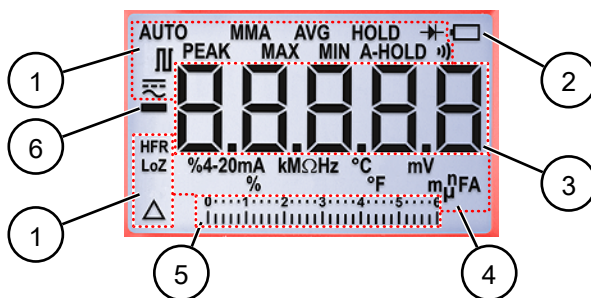

Figure 8: Digital display

1	Display of functions	2	Battery status
3	Display range	4	Display of units
5	Bargraph indication	6	Polarity

4.2 Functions

Use the rotary switch to switch the device on (desired measuring function) or off (“OFF”).

The device confirms each operation of keys with an acoustic signal. The device switches off automatically after approx. 30 minutes (APO, Auto-Power-Off). To switch the device back on, press the “HOLD” key or first set the rotary switch to switch position “OFF” and then set the desired measuring function.

4.2.1 Blue “Function” key

Selecting a function

Press the blue “Function” key to select the second, third, fourth or fifth function of the respective rotary switch position.

The last selected function will be stored for each rotary switch position and automatically preselected when setting the function again and after switching the device on again.









Rotary switch position (symbol / designation)		Functions
AutoV LoZ	AutoV LoZ	AutoV LoZ
HFR 	V-AC	V-AC → HFR
 V	V	V-DC → V-AC+DC
 mV	mV	mV-DC → mV-AC → mV-AC+DC → logic (Hz) → logic (%)
 Ω	Ω	Ω → continuity
	Capacitance measurement	Capacitance → diode
	Temperature measurement	°C → °F
A  mA %4-20mA	A / mA	A / mA-DC → A / mA-AC → A / mA-AC+DC → 4-20 mA (%)
μA 	μA	μA-DC → μA-AC → μA-AC+DC

Table 4: Selecting a function

“HFR (AC)” function (low-pass filter)

The “HFR (AC)” function is intended for connecting a low-pass filter (high-frequency suppression) during AC voltage measurement. With this low-pass filter, it is possible to filter out high-frequency pulses, e. g. on pulsed motor drives.

Press the blue “Function” key to enable or disable the function. With the function being enabled, the “HFR” symbol is shown on the digital display.

The limiting frequency (-3 dB) of the filter is approx. $f_g = 1\,000$ Hz. When reaching the limiting frequency f_g , the displayed value is lower by a factor of 0.707 than the actual value without filter.

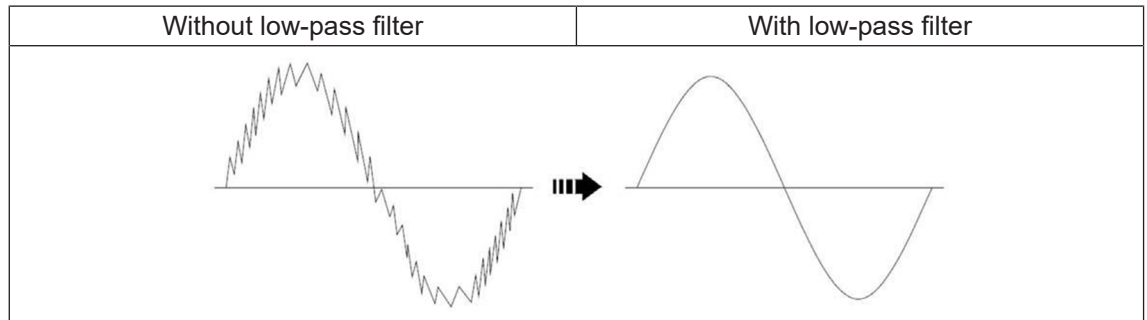

Table 5: Low-pass filter

Display illumination

Press the blue “Function” key (>1 second) to switch on the background lighting of the digital display. After approx. 16 minutes, the background lighting is automatically switched off again. Alternatively, press the blue “Function” key (>1 second) to switch off the background lighting manually.

4.2.2 “MIN MAX” key

“MIN MAX” function

The “MIN MAX” function automatically records the lowest and highest measured value as well as the average value of a measurement series.

Press the “MIN MAX” key to enable the “MIN MAX” function. With the function being enabled, the “MMA” symbol is shown on the digital display. Press the “MIN MAX” key (>1 second) to disable the “MIN MAX” function afterwards.

The device confirms each detection of a new maximum or minimum value with a brief acoustic signal. Press the “MIN MAX” key to toggle between the display of the maximum (MAX), minimum (MIN), average (AVG) and currently measured value (MAX AVG MIN).

The minimum signal duration is 300 ms (V-DC / A-DC) or 460 ms (V-AC / A-AC), respectively. If the “MIN MAX” function is enabled, the automatic switch-off (APO, Auto-Power-Off) is disabled.

4.2.3 “Hz” key

“Hz” function

The “Hz” function is intended for measuring the mains frequency.

Press the “Hz” key to enable the “Hz” function. With the function being enabled, the “Hz” symbol is shown on the digital display. Press the “Hz” key (>1 second) to disable the function afterwards.

The device determines the frequency of a voltage or a current signal by counting how many times per second the signal exceeds a certain threshold (level). When the “Hz” function is enabled, the input sensitivity adjusts automatically depending on the measuring function used. Press the “Hz” key to manually set the available trigger thresholds according to the following table. Level 0 has the highest sensitivity and level 3 the lowest sensitivity. The currently set level is indicated by markings in the bargraph indication.

Trigger threshold	V (AC, DC, AC+DC)	HFR (AC)	µA	mA	A
Level 0	6 V	-	600 µA	60 mA	6 A
Level 1	60 V	-	6 000 µA	600 mA	10 A
Level 2	600 V	600 V	-	-	-
Level 3	1 000 V	1 000 V	-	-	-

Table 6: Trigger thresholds

It is recommended to measure the measuring signal (voltage or current) in the automatic measuring range selection (AUTO) first so that the trigger threshold is set automatically, and only then to enable the “Hz” function. If the measured value is not stable, use a lower sensitivity to suppress interference. If the measured value is 0 Hz, use a higher sensitivity.

4.2.4 “VoltSense” key

“Voltage indicator” function

The “Voltage indicator” function is intended for non-contact localisation of AC voltages to earth.

Press the “VoltSense” key to enable the “Voltage indicator” function and to set the sensitivity. Press the “VoltSense” key (>1 second) to disable the function afterwards.

4.2.5 “PEAK” key

“PEAK” function

The “PEAK” function records and stores the positive and negative peak value (>0.35 ms) during voltage or current measurement (except for AutoV LoZ).

Press the “PEAK” key to enable the “PEAK” function. With the function being enabled, the “PEAK” symbol is shown on the digital display. Press the “PEAK” key (>1 second) to disable the function afterwards.

The device confirms each detection of a new maximum or minimum value with a brief acoustic signal. Press the “PEAK” key to toggle between the display of the maximum value (MAX) and the minimum value (MIN).

4.2.6 “HOLD” key

The “HOLD” key has two functions.

“HOLD” function

The “HOLD” function is intended for holding the currently measured value.

Press the “HOLD” key to hold the currently measured value and the “H” symbol is shown on the digital display. Press the “HOLD” key again to discard the held measured value and the currently measured value will be displayed again.

“A-HOLD” function

The “A-HOLD” function is intended for automatically storing a stable measured value during voltage, current, resistance measurement and continuity testing.

Press the “HOLD” key (>1 second) to enable or disable the “A-HOLD” function. With the function being enabled, the “A-HOLD” symbol is shown on the digital display.

Bring both safety measuring lines into contact with the measuring points simultaneously and ensure a good connection. In case of a valid measurement, the currently measured value is shown on the digital display. As soon as the device detects a stable measured value, a brief acoustic signal is emitted and the “A-HOLD” symbol flashes. Remove the safety measuring lines from the measuring points simultaneously and the stored measured value will be flashing on the digital display.

Notes on the “A-HOLD” function:

- Valid for measurements >5 % of the final measuring range value, no OL in the resistance measuring range.
- A measured value is considered to be stable if two measured values directly following each other show a difference of ≤ 30 digits.
- Three brief acoustic signals and a flashing “----” display mean that no stable measured value has been recorded.
- The function might be impaired by a poor connection or by not connecting / disconnecting the safety measuring lines at the same time.

4.2.7 “REL Δ ” key

“Relative value” function

The “Relative value” function is intended for storing the currently displayed measured value when the function is enabled. Afterwards, until the function is disabled, the difference (offset) between the stored measured value and the following measured values is shown on the digital display.

Press the “REL Δ ” key to enable or disable the “Relative value” function. With the function being enabled, the “ Δ ” symbol is shown on the digital display.

4.2.8 “RANGE” key

“Measuring range” function

Press the “RANGE” key to disable the automatic measuring range selection (AUTO) and set the measuring range manually. Press the “RANGE” key (>1 second) to enable the automatic measuring range selection afterwards (the “AUTO” symbol will be displayed).

The manual measuring range selection is not available for the following functions:

- AutoV LoZ
- Capacitance measurement
- Frequency measurement

4.2.9 “AutoV LoZ” function

“AutoV” function

The corresponding measuring function (AC or DC voltage) and the optimum measuring range are set automatically. Without a measuring signal, the “Auto” symbol is displayed. The coupling mode (AC or DC) is set automatically from 1 to 1 000 V, depending on which peak value (AC or DC) is higher. Other available functions are “HOLD” [▶ page 23], “A-HOLD” [▶ page 23] and “Voltage indicator” [▶ page 22].

“LoZ” function

The input resistance briefly is only approx. 2.1 kΩ in order to suppress unwanted inductive and capacitive voltages (reactive voltages) and increases within fractions of a second to several hundred kΩ in case of high-energy voltages.

4.2.10 Jack control

The device is provided with a visual and acoustic jack control. If a rotary switch position is set that is not admissible for the “A” or “μA / mA” jacks (e. g. voltage measurement) and a safety measuring line is plugged into this socket, an acoustic signal will be emitted and the “InEr” (‘Input error’) will be shown on the digital display to protect the device.

A non-functioning visual and acoustic jack control indicates a defective fuse.

4.2.11 Further setting options

The device offers further setting options. To change a setting, press and hold one of the following keys and simultaneously set any measuring function from the “OFF” position of the rotary switch of the device until the corresponding symbol is shown on the digital display.

- Blue “Function” key: Temporarily disables the automatic switch-off (APO, Auto-Power-Off) (“dSAPO” is displayed). If the device is switched off (switch position “OFF”), the automatic switch-off (APO) will be enabled again when you switch the device on again.
- “RANGE” key: Disables (“dSbEP” is displayed) or enables (“EnbEP” is displayed) the acoustic signal of the device. The device saves the last setting and automatically preselects it even after being switching on again.

Enabling or disabling temperature units

The measured temperature [▶ page 38] can be displayed in °C or °F. If both temperature units are enabled, you can select the temperature unit before measuring the temperature. Alternatively, you can disable a temperature unit so that it is not possible to select it prior to temperature measurement.

- Enabling the temperature units °C and °F:
 - Press and hold the “VoltSense” key and simultaneously set any switch position from the “OFF” position of the rotary switch of the device until “C-F” is shown on the digital display.
- Disabling the temperature unit °F:
 - If necessary, enable the temperature units °C and °F.
 - In the switch position “Temperature measurement”, press the blue “Function” key to set the temperature unit °C and switch the device off (switch position “OFF”).
 - Press and hold the “PEAK” key and simultaneously set any switch position from the “OFF” position of the rotary switch of the device until “C” is shown on the digital display.
- Disabling the temperature unit °C:
 - If necessary, enable the temperature units °C and °F.
 - In the switch position “Temperature measurement”, press the blue “Function” key to set the temperature unit °F and switch the device off (switch position “OFF”).
 - Press and hold the “PEAK” key and simultaneously set any switch position from the “OFF” position of the rotary switch of the device until “F” is shown on the digital display.

4.3 Measuring ranges

The device is provided with an automatic and a manual switch-over of the measuring range. If a measured value is outside the measuring range, this is indicated by “0L” or “-0L”. Please note that there will be no indication and warning in case of overload.

Measuring accuracy

The measuring accuracy is specified as the sum of the following:

- Relative part of the measured value
- Number of digits (counting steps of the last digit)

The specified measuring accuracy applies at a temperature of 23 °C ±5 °C and a relative air humidity lower than 75 %. In case of deviating temperatures, observe the temperature coefficient by adding the following value to the specified measuring accuracy:

0.1 [1/°C] x specified measuring accuracy x difference to reference temperature range [°C]
(at -20 ... 18 °C or 28 ... 55 °C or specified otherwise)

Additional specifications for AC functions

The measured value is obtained and displayed as a true r.m.s. value (TRUE RMS). For non-sinusoidal curves, the accuracy of the displayed value decreases.

Maximum crest factor of the measuring signal:

- For 50 % of the final measuring range value: 3.2
- For 100 % of the final measuring range value: 1.6
- Square-wave signals are not specified.

4.3.1 Voltage ranges

AC voltage ranges (V-AC, V-AC+DC)

Overload protection: 1 100 V-AC / V-DC

Measuring range	Resolution	Measuring accuracy
600 mV ¹⁾	0.01 mV	50 ... 60 Hz, AC: ±(0.5 % + 30 digits)
6 V	0.1 mV	50 ... 60 Hz, AC+DC: ±(0.7 % + 40 digits)
60 V	0.001 V	40 Hz ... 1 kHz, AC: ±(1.2 % + 30 digits)
600 V	0.01 V	40 Hz ... 1 kHz, AC+DC: ±(1.4 % + 40 digits)
1 000 V	0.1 V	1 ... 7 kHz, AC: ±(2.0 % + 40 digits) ²⁾ 1 ... 7 kHz, AC+DC: ±(2.2 % + 50 digits) ²⁾

Table 7: AC voltage ranges (V-AC, V-AC+DC)

- 1) Peak values including DC bias voltage <1 000 mV peak
 - 2) Measuring accuracy plus 1 % at >5 ... 7 kHz, 1 000 V measuring range: Not specified
- Input resistance: 10 MΩ II, 75 pF (140 pF in the 600 mV range)
 - Display value with short-circuited safety measuring lines: <50 digits

AC voltage ranges (HFR V-AC)

Overload protection: 1 100 V-AC / V-DC

Measuring range	Resolution	Measuring accuracy
600 V	0.01 V	10 ... 200 Hz: $\pm(4.0 \% + 50 \text{ digits})$
1 000 V	0.1 V	200 ... 440 Hz: $\pm(10.0 \% + 50 \text{ digits})^{1)}$

Table 8: AC voltage ranges (HFR V-AC)

- 1) Measuring accuracy linearly decreasing from $\pm(2.0 \% + 50 \text{ digits})$ at 200 Hz to $\pm(10.0 \% + 50 \text{ digits})$ at 440 Hz, frequencies >440 Hz are not specified
- Limiting frequency f_g (-3 dB): approx. 1 000 Hz

DC voltage ranges (V-DC)

Overload protection: 1 100 V-AC / V-DC

Measuring range	Resolution	Measuring accuracy
600 mV	0.01 mV	$\pm(0.03 \% + 2 \text{ digits})$
6 V	0.1 mV	
60 V	0.001 V	
600 V	0.01 V	$\pm(0.05 \% + 5 \text{ digits})$
1 000 V	0.1 V	$\pm(0.15 \% + 5 \text{ digits})$

Table 9: DC voltage ranges (V-DC)

- Input resistance: 10 M Ω II, 75 pF (280 pF in the 600 mV range)

Voltage ranges (LoZ, AutoV)

Overload protection: 1 100 V-AC / V-DC

Measuring range	Resolution	Measuring accuracy
6 V	0.1 mV	DC (0 Hz): $\pm(0.5 \% + 30 \text{ digits})$
60 V	0.001 V	AC (50 ... 60 Hz): $\pm(1.0 \% + 40 \text{ digits})^{1)}$
600 V	0.01 V	
1 000 V	0.1 V	

Table 10: Voltage ranges (LoZ, AutoV)

- 1) Measuring accuracy applies to 10 ... 100 % of the final measuring range value:
- Minimum sensitivity: >1 V-AC (50 / 60 Hz), >1.0 V-DC, <-1.0 V-DC)
 - Input resistance: Initially 2.1 k Ω II, 140 pF, rapidly increasing for display values >50 V.
Typical input resistances depending on the display values: 12 k Ω at 100 V, 90 k Ω at 300 V, 300 k Ω at 600 V, 670 k Ω at 1 000 V

4.3.2 Current ranges

AC ranges (A-AC)

Overload protection: 11 A-AC / A-DC

Measuring range	Resolution	Measuring accuracy 40 Hz ... 3 kHz	Voltage drop
600 μ A	0.01 μ A	AC: $\pm(0.9\% + 20$ digits)	0.2 mV/ μ A
6 mA	0.1 μ A	AC+DC: $\pm(1.0\% + 30$ digits)	
60 mA	0.001 mA	AC: $\pm(0.9\% + 20$ digits)	2.0 mV/mA
600 mA	0.01 mA	AC+DC: $\pm(1.2\% + 40$ digits)	
6 A	0.1 mA	AC: $\pm(1.0\% + 30$ digits)	30 mV/A
10 A ¹⁾	0.001 A	AC+DC: $\pm(1.2\% + 40$ digits)	

Table 11: AC ranges (A-AC, A-AC+DC)

- 1) A 10 A continuous measurement is only admissible for ambient temperatures $<40\text{ }^{\circ}\text{C}$.
- 40 ... 55 $^{\circ}\text{C}$: The maximum measuring time is 3 minutes (pause >15 minutes).
 - 10 ... 20 A: The maximum measuring time is 30 seconds (pause >15 minutes).

DC ranges (A-DC)

Overload protection: 11 A-AC / A-DC

Measuring range	Resolution	Measuring accuracy	Voltage drop
600 μ A ¹⁾	0.01 μ A	$\pm(0.075\% + 20$ digits)	0.2 mV/ μ A
6 mA	0.1 μ A		
60 mA	0.001 mA		2.0 mV/mA
600 mA	0.01 mA	$\pm(0.15\% + 20$ digits)	30 mV/A
6 A	0.1 mA	$\pm(0.3\% + 20$ digits)	
10 A ²⁾	0.001 A	$\pm(0.3\% + 30$ digits)	

Table 12: DC ranges (A-DC)

- 1) If the safety measuring lines are short-circuited, the display value might have a negative residual value (a few digits). The residual value results from the integrated input protection and has no influence on the measuring accuracy.
- 2) A 10 A continuous measurement is only admissible for ambient temperatures $<40\text{ }^{\circ}\text{C}$.
- 40 ... 55 $^{\circ}\text{C}$: The maximum measuring time is 3 minutes (pause >15 minutes).
 - 10 ... 20 A: The maximum measuring time is 30 seconds (pause >15 minutes).

4 - 20 mA DC current loop (%)

Measuring range	Resolution	Measuring accuracy
0 % (4 mA) ... 100 % (20 mA)	0.01 %	± 25 digits

Table 13: 4 - 20 mA DC current loop (%)

4.3.3 Resistance ranges

Overload protection: 1 000 V-AC / V-DC

Measuring range	Resolution	Measuring accuracy ¹⁾
600 Ω	0.01 Ω	±(0.085 % + 10 digits)
6 kΩ	0.0001 kΩ	±(0.085 % + 4 digits)
60 kΩ	0.001 kΩ	±(0.085 % + 4 digits)
600 kΩ	0.01 kΩ	±(0.15 % + 4 digits)
6 MΩ	0.0001 MΩ	±(1.5 % + 5 digits)
60 MΩ	0.001 MΩ	±(2.0 % + 5 digits) ±(2.5 % + 5 digits) at >50 MΩ

Table 14: Resistance ranges (Ω)

¹⁾ Temperature coefficient (at -20 ... 18 °C or 28 ... 55 °C): 0.2 [1/°C] x specified measuring accuracy x difference to reference temperature range [°C]

- Open-circuit voltage: <1.3 V-DC (<1.5 V-DC in the 600 Ω range)
- Testing current: approx. 0.1 μA in the 6 MΩ range and approx. 0.01 μA in the 60 MΩ range

4.3.4 Continuity test

Overload protection: 1 000 V-AC / V-DC

Measuring range	Resolution	Measuring accuracy
600 Ω	0.01 Ω	±(0.085 % + 10 digits)

Table 15: Continuity test

- The integrated buzzer sounds and the display illumination flashes at a resistance lower than 100 ... 420 Ω.
- Response time: <100 μs

4.3.5 Diode test

Overload protection: 1 000 V-AC / V-DC

Measuring range	Resolution	Measuring accuracy
3.0 V	0.1 mV	±(1.0 % + 20 digits)

Table 16: Diode test

- Open-circuit voltage: <3.1 V-DC; testing current: approx. 0.35 mA
- Forward voltage <0.85 V: Brief acoustic signal of the buzzer; forward voltage <0.1 V: Long acoustic signal of the buzzer
- Optical indication: Display illumination

4.3.6 Capacitance ranges

Requirements: Discharge the capacitors and apply the safety measuring lines according to the marked polarity.

Overload protection: 1 000 V-AC / V-DC

Measuring range	Resolution	Measuring accuracy ^{1), 2)}
10 nF	0.01 nF	±(1.0 % + 10 digits)
100 ... 1 000 nF	Max. 0.1 nF	±(1.0 % + 2 digits)
10 ... 1 000 µF	Max. 0.01 µF	±(1.8 % + 4 digits)
10 mF	0.01 mF	±(2.0 % + 4 digits)

Table 17: Capacitance ranges (F)

- 1) Valid for film capacitors or better
- 2) Temperature coefficient (at -20 ... 18 °C or 28 ... 55 °C): 0.2 [1/°C] x specified measuring accuracy x difference to reference temperature range [°C]

4.3.7 Frequency ranges

Mains frequency ranges

Overload protection: 1 000 V-AC / V-DC, 11 A-AC / A-DC

Measuring function range	Sensitivity (sinusoidal RMS)	Measuring range
6 V	0.4 V	10 Hz ... 50 kHz
60 V	4 V	
600 V	40 V	10 Hz ... 30 kHz
1 000 V	400 V	10 Hz ... 5 kHz
HFR 600 V	40 V	10 ... 400 Hz
HFR 1 000 V	400 V	
600 µA	40 µA	10 Hz ... 5 kHz
6 mA	400 µA	
60 mA	4 mA	
600 mA	40 mA	
6 A	0.6 A	10 Hz ... 3 kHz
10 A	6 A	

Table 18: Mains frequency ranges (Hz)

- Measuring accuracy: ±(0.05 % + 5 digits)

5 V logic-level frequency ranges

Measuring range	Resolution	Measuring accuracy
5 Hz ... 1 MHz	Max. 0.001 Hz	±(0.002 % + 4 digits)

Table 19: 5 V logic-level frequency ranges (Hz)

- Min. sensitivity: >3.0 V_{peak} (square)
- Pulse width: >0.5 µs

Logic-level duty cycle

Frequency range (5 V logic level)	Measuring range	Measuring accuracy
5 Hz ... 1 kHz	0.10 ... 99.99 %	±(3 digits per kHz + 2 digits)
1 ... 10 kHz	1.00 ... 99.00 %	
10 ... 500 kHz	20.00 ... 80.00 %	

Table 20: Logic-level duty cycle (%)

- Min. sensitivity: $>3.0 V_{\text{peak}}$ (square)

4.3.8 Temperature ranges

Overload protection: 1 000 V-AC / V-DC

Measuring range	Resolution	Measuring accuracy ^{1), 2)}
-200 ... 1 090 °C	0.1 °C	±(1.0 % + 1 °C)
-328 ... 1994 °F	0.1 °F	±(1.0 % + 1.8 °F)

Table 21: Temperature ranges (°C / °F)

- 1) Add the measuring accuracy of the wire temperature sensor (type K) to the specified measuring accuracy.
 - Measuring range: -20 ... 200 °C (-4 ... 392 °F)
 - Measuring accuracy: ±1.5 °C (±1.8 °F)
- 2) The measuring accuracy applies to stable ambient temperatures lower than ±1° C. After a change of the ambient temperature of ±2 °C, the measuring accuracy specifications will apply after 2 hours.

5 Operation

The device enables you to carry out various tests and measurements.

5.1 Requirements for tests and measurements

- Remove the device (safety measuring lines) from the measuring point before setting a switch position on the rotary switch of the device.
- Only use approved safety measuring lines [▶ page 33].
- Please consider sources of interference that might be present. Strong sources of interference in the vicinity of the device might involve unstable readings and measuring errors.
- For carrying out the tests and measurements, please observe the associated measuring ranges and measuring accuracies stated in the chapter Measuring ranges [▶ page 26].
- Please note that the last selected function will be stored for each rotary switch position. When setting the rotary switch again (e. g. after switching the device on), the last selected function will be preselected automatically.



DANGER

Maximum admissible voltage

Danger to life or serious injury is possible due to contact with high electric voltage.

- Use the device only in electric circuits up to overvoltage category CAT III with a conductor for a maximum of 1 000 V or up to overvoltage category CAT IV with a conductor for a maximum of 600 V to earth.

5.2 Connecting the safety measuring lines

For certain tests and measurements, it is necessary to connect the safety measuring lines to the device.

Requirements

- Please observe the requirements for measuring [► page 32].
- Safety measuring lines
The safety measuring lines must be approved for the device (e. g. safety measuring lines included in the scope of delivery) and be in a technically perfect and operationally safe condition.
 - Check the specifications regarding nominal voltage and nominal current.
 - Check the insulation of the safety measuring lines.
 - Check the safety measuring lines for continuity.
 - Replace defective safety measuring lines.
- Protective caps (depending on the overvoltage category)
- During tests and measurements, only touch the safety measuring lines in the area intended for your hands.



⚠ WARNING

Dangerous voltage

Danger to life or serious injury is possible due to contact with high electric voltage in case of incorrect operation.

- Do not touch the bare measuring probe tips of the safety measuring lines or the bare contacts of the optional alligator clips. Only touch the safety measuring lines in the area intended for your hands.
- Connect the safety measuring lines to the correspondingly marked measuring jacks of the device and check them for tight fit.
- Only use approved safety measuring lines.
- Attach the protective caps to the contact tips of the safety measuring lines (circuits of overvoltage category CAT III or IV).
- When disconnecting the measuring circuit, first remove the live safety measuring line (phase) and then the neutral safety measuring line from the measuring point.

Procedure

1. Connect the black safety measuring line to the COM jack of the device.
2. Connect the red safety measuring line to the following jack of the device depending on the planned test or measurement:
 - Jack for voltage, frequency, duty cycle, resistance or capacitance measurement, continuity or diode testing
 - μA mA: current measurement
 - A: current measurementPlease observe the information for visual and acoustic jack control [► page 24].
3. Measurements or tests with test probes in electric circuits of overvoltage category CAT III or CAT IV: Attach the protective caps to the contact tips of the safety measuring lines.

5.3 Voltage, frequency or duty cycle measurement

Requirements

- Please observe the requirements for measuring [▶ page 32].
- Approved safety measuring lines
- Voltage ranges [▶ page 26] and frequency ranges [▶ page 30]



Figure 9: Voltage, frequency or duty cycle measurement

Procedure

1. Set the rotary switch of the device to switch position “V-AC”, “V”, “mV” or “AutoV LoZ”.
2. Connect the safety measuring lines to the device [▶ page 33].
3. Set the desired measuring function.
 - “V-AC”: If necessary, you can enable the “HFR (AC)” function (low-pass filter) by pressing the blue “Function” key. As an alternative to voltage measurement, you can switch to frequency measurement by pressing the “Hz” key.
 - “V”: Press the blue “Function” key to set the desired coupling mode of the voltage measurement (DC or AC+DC). As an alternative to voltage measurement, you can switch to frequency measurement by pressing the “Hz” key.
 - “mV”: Press the blue “Function” key to set the desired coupling mode of the voltage measurement (DC, AC or AC+DC) or, for logic signals, to set frequency or duty cycle measurement.
 - “AutoV LoZ”: The corresponding measuring function (AC or DC voltage) and the optimum measuring range are set automatically. The input resistance is briefly reduced to approx. 2.1 kΩ in order to suppress unwanted inductive and capacitive voltages (reactive voltages).
4. Bring the safety measuring lines into contact with the measuring points and read the measured value on the digital display.

5.4 Current or frequency measurement

Requirements

- Please observe the requirements for measuring [▶ page 32].
- Approved safety measuring lines
- Current ranges [▶ page 28] and frequency ranges [▶ page 30]



Figure 10: Current or frequency measurement

Procedure

1. Set the rotary switch of the device to switch position “A / mA” or “ μ A”.
2. Connect the safety measuring lines to the device [▶ page 33].
3. Press the blue “Function” key to set the desired coupling mode of the current measurement (DC, AC or AC+DC) or, depending on the jack used, the measuring function “%4-20mA”. As an alternative to current measurement, you can switch to frequency measurement by pressing the “Hz” key.
4. Bring the safety measuring lines into contact with the measuring points and read the measured value on the digital display.

5.5 Resistance measurement or continuity testing

Requirements

- Please observe the requirements for measuring [▶ page 32].
- Approved safety measuring lines
- Resistance ranges [▶ page 29] and continuity test [▶ page 29]



Figure 11: Resistance measurement or continuity test

Procedure

1. Set the rotary switch of the device to switch position “Ω”.
2. Connect the safety measuring lines to the device [▶ page 33].
3. Press the blue “Function” key to set the function “Resistance measurement” (“Ω” symbol is displayed) or “Continuity test” (“⦿”) symbol is displayed).
4. Bring the safety measuring lines into contact with the measuring points.
 - Resistance measurement: Read the measured value.
 - Continuity test: When the buzzer sounds (acoustic signal) and the digital display lights, the line resistance between the COM jack and the jack for continuity testing falls below the value of 100 to 420 Ω.

5.6 Capacitance measurement or diode testing

Requirements

- Please observe the requirements for measuring [▶ page 32].
- Approved safety measuring lines
- Capacitance ranges [▶ page 30] and diode test [▶ page 29]



NOTICE

Capacitors not discharged

Measuring the capacitance at capacitors that are not fully discharged can damage the device.

- Discharge the capacitors completely before measuring the capacitance.
- Do not apply any voltage to the jacks of the device during the capacitance measurement.



Figure 12: Capacitance measurement or diode testing

Procedure

1. Set the rotary switch of the device to switch position “capacitance measurement”.
2. Connect the safety measuring lines to the device [▶ page 33].
3. Press the blue “Function” key to set the function “Capacitance measurement” (“F” symbol) or “Diode test” (“ \rightarrow ” symbol).
4. Bring the safety measuring lines into contact with the discharged capacitor or the diode – observing correct polarity – and read the measured value on the digital display.

Notes on diode testing:

- Standard Si diode applied in forward direction: A forward voltage from 0.4 to 0.8 V is displayed.
 - “000”: indicates a short circuit inside the diode.
 - “OL”: indicates an interruption inside the diode.
- Diode applied in reverse direction: “OL” is displayed. In case of defective diodes, “000” or other values will be displayed.

5.7 Temperature measurement

Requirements

- Please observe the requirements for measuring [▶ page 32].
- Temperature sensor

The temperature sensor must be approved for the device (e. g. wire temperature sensor of type K included in the scope of delivery) and be in a technically perfect and operationally safe condition.

- Temperature ranges [▶ page 31]



Figure 13: Temperature measurement

Procedure

1. Set the rotary switch of the device to switch position “Temperature measurement”.
2. Press the blue “Function” key to set the temperature unit (°C or °F). The selected temperature unit is shown on the digital display. Please note that you can optionally disable a temperature unit [▶ page 25].
3. Connect the temperature sensor to the device observing correct polarity and make sure that it is firmly connected.
 - Negative pole into the COM jack
 - Positive pole into the jack for temperature measurement
4. Position the contact point (end of the wire temperature sensor) at the measuring point.
5. Wait until the measured value on the digital display has stabilised and read it.

5.8 Voltage indicator



⚠ WARNING

Incorrect use of the function

Danger to life or serious injury is possible due to contact with high electric voltage if the “Voltage indicator” function is used incorrectly.

- Please observe that a dangerous contact voltage might be applied even if it is not indicated by a visual or acoustic signal.
- Do not use the “Voltage indicator” function to test for the absence of voltage.

5.8.1 Non-contact phase testing

There is a detector located on the top right of the device. This detector enables non-contact detection of alternating fields.

Requirements

- Please observe the requirements for measuring [[page 32](#)].
- Make sure that no voltage is applied to the jacks of the device. Remove any connected safety measuring lines.



Figure 14: Non-contact phase testing

Procedure

1. Set the rotary switch of the device to switch position "V-AC".
2. Press the "VoltSense" key to enable the "Voltage indicator" function.
"EF-H" appears on the digital display (electric field with high sensitivity).
If necessary, you can reduce the sensitivity by pressing the "VoltSense" key again. "EF-L" appears on the digital display (electric field with low sensitivity).
3. Place the top right of the device near the measuring point.
If the device detects the phase of an earthed AC voltage, the symbol "EF-H" or "EF-L" will disappear. A bargraph indication and an acoustic signal indicate the strength of the electric field.

Practical tip

Interruptions (cable breaks) in exposed cables – e. g. in cable reels, chains of light, etc. – can be traced from the feeding point (phase) to the point of interruption.

Functional range: ≥ 230 V

5.8.2 External conductor or phase testing

Requirements

- Please observe the requirements for measuring [▶ page 32].
- Approved black safety measuring line
- Make sure that no voltage is applied to the other jacks of the device. Remove a connected red safety measuring line.



Figure 15: External conductor or phase testing

Procedure

1. Set the rotary switch of the device to switch position “V-AC”.
2. Connect the black safety measuring line to the COM jack of the device [▶ page 33].
3. Press the “VoltSense” key to enable the “Voltage indicator” function.
“EF-H” appears on the digital display (electric field with high sensitivity).
If necessary, you can reduce the sensitivity by pressing the “VoltSense” key again. “EF-L” appears on the digital display (electric field with low sensitivity).
4. Bring the safety measuring line into contact with the measuring point (system part).
If the device detects the phase of an earthed AC voltage, the symbol “EF-H” or “EF-L” will disappear. A bargraph indication and an acoustic signal indicate the strength of the electric field.

6 Maintenance

The battery compartment and the housing may be opened for maintenance work. Apart from that, there are no components in the device that you can replace.



⚠ WARNING

Opening the device

Danger to life or serious injury is possible due to contact with high electric voltage when opening the device. The device might get damaged.

- Make sure that the device is free of voltage before opening the battery compartment or housing.
- Do not open the device (except for the battery compartment and replacing a fuse).
- Please contact your specialty retailer or the returns management for any repairs [▶ page 9].

6.1 Maintenance schedule

The following table provides an overview of all maintenance and servicing work that you must carry out permanently or at regular intervals.

Interval	Measures
Regularly, as needed	<ul style="list-style-type: none"> • Cleaning the device [▶ page 43]
As needed	<ul style="list-style-type: none"> • Replacing the batteries [▶ page 44]
Every 12 months	<ul style="list-style-type: none"> • Calibrating the device [▶ page 44]

Table 22: Maintenance schedule

6.2 Making the device free of voltage

If you want to open the battery compartment or the housing for maintenance work, make sure first that the device is free of voltage.

Procedure

1. Remove the device from the measuring point.
2. Disconnect the safety measuring lines from the device.
3. Set the rotary switch of the device to switch position “OFF”.

6.3 Cleaning the device

Clean the device regularly and as the need arises. Make sure that the battery compartment and the battery contacts are not contaminated by leaking battery electrolyte.

Requirements

- A clean and dry cloth or special cleaning cloth
- Voltage-free device [[▶ page 42](#)]



NOTICE

Wrong cleaning agents

Using the wrong cleaning agents can damage the device.

- Do not use any solvents, abrasives or polishing agents.

Procedure

1. Clean the exterior of the device with a clean and dry cloth or a special cleaning cloth.
2. Check the battery compartment. To open and close the battery compartment, follow the procedure given in the chapter Replacing the batteries [[▶ page 44](#)].
3. In case of electrolyte contamination or white deposits in the area of the battery or the battery compartment, clean the batteries and these areas by means of a clean and dry cloth. Replace the batteries [[▶ page 44](#)], if necessary.

6.4 Replacing the batteries

The device is powered by three 1.5 V micro batteries (AAA / IEC LR03). Replace the batteries as soon as they are discharged.

Requirements

- Discharged batteries inside the device (the battery symbol on the digital display is shown permanently)
- 3 new 1.5 V micro batteries (AAA / IEC LR03)
- Voltage-free device [▶ page 42]
- Suitable Phillips screwdriver

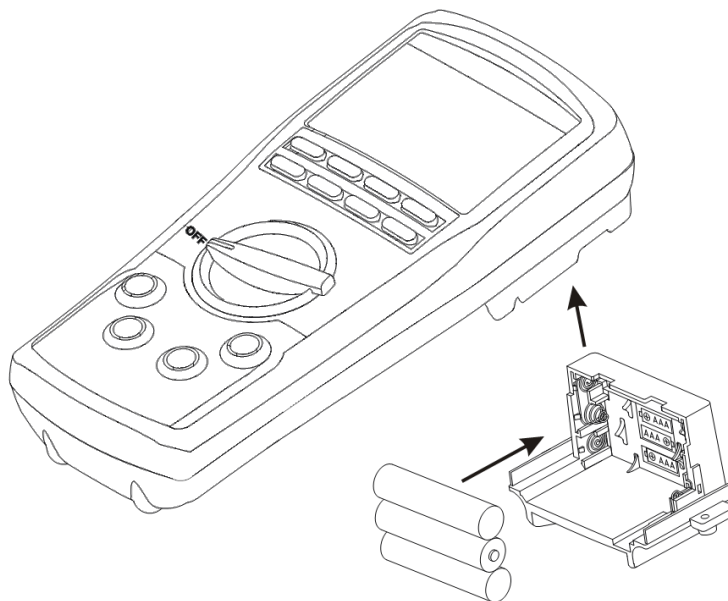

Figure 16: Battery replacement (exemplary)

Procedure

1. Place the device face down (onto an anti-slip surface).
2. Unscrew the two screws of the battery compartment.
3. Lift the battery compartment out of the device.
4. Remove the discharged batteries from the battery compartment and dispose of them properly [▶ page 47].
5. Insert the new batteries into the battery compartment observing correct polarity.
6. Place the battery compartment back into the device and tighten the two screws.

6.5 Calibrating the device

Benning guarantees compliance with this technical and accuracy specifications stated in this operating manual for the first 12 months after the delivery date.

To maintain accuracy of the measuring results, make sure that the device is recalibrated in annual intervals by the BENNING Service [▶ page 9] .

6.6 Replacing the fuses

The device is protected against overload by means of two fuses. Replace a fuse if it is defective.

Requirements

- Defective fuse inside the device
A non-functioning visual and acoustic jack control [► page 24] indicates a defective fuse.
- New fuse:
 - F1: F 11 A, 1 000 V, 20 kA (or better), d = 10 mm, l = 38 mm, e. g. item no. 10218772)
 - F2: F 0.4 A, 1 000 V, 30 kA (or better), d = 6 mm, l = 32 mm, e. g. item no. 10231514)
- Voltage-free device
- Slotted screwdriver and suitable Phillips screwdriver

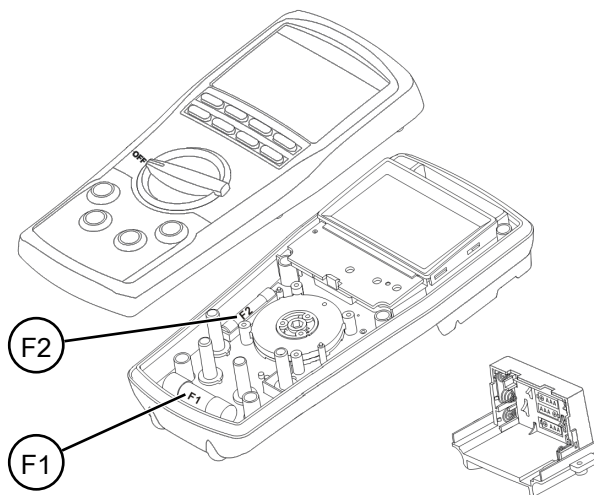

Figure 17: Fuse replacement (exemplary)

Procedure

1. Place the device face down (onto an anti-slip surface).
2. Dismantle the battery compartment [► page 44].
3. Unscrew the six screws of the housing (two screws each under the foldable stand and the battery compartment).
4. Carefully lift the bottom part of the housing off the front part.
5. Laterally lift one end of the defective fuse off the fuse holder by means of a slotted screwdriver.
6. Remove the defective fuse from the fuse holder and dispose of them properly [► page 47].
7. Insert the new fuse and position it centrally in the fuse holder.
8. Carefully reassemble the bottom of the housing and the front part. For this, make sure that the rotary switch is in the "OFF" position.
9. Tighten the six screws of the housing.
10. Place the battery compartment back into the device and tighten the two screws.

7 Technical data

Protection class	II (double or reinforced insulation)
Contamination level	2
Protection category (DIN VDE 0470-1, IEC / EN 60529)	IP 40 1st digit: 4 = protection against access to dangerous parts and protection against solid impurities (diameter >1.0 mm) 2nd digit: 0 = no protection against water
Overvoltage category	<ul style="list-style-type: none"> • CAT III 1 000 V to earth • CAT IV 600 V to earth
Housing dimensions (length x width x height)	193 mm x 89 mm x 51 mm
Weight (batteries included)	0.420 kg
Battery life (alkaline batteries)	Approx. 150 h (without background lighting)
Silicone safety measuring lines (item no.: 10231315)	
Standard	IEC / DIN EN 61010-031 (VDE 0411-031)
Overvoltage category (only applies to the safety measuring lines, additionally observe the limitations of the device)	<ul style="list-style-type: none"> • With attachable protective cap: <ul style="list-style-type: none"> – CAT III 1 000 V to earth – CAT IV 600 V to earth • Without attachable protective cap: <ul style="list-style-type: none"> – CAT II 1 000 V to earth
Protection class	II (double or reinforced insulation)
Contamination level	2
Max. rated current	10 A
Length	1.0 m
Operation	
Max. barometric altitude	2 000 m
Operating temperature	-20 ... 55 °C (do not permanently expose the device to sunlight; please observe the limitations for current measurement [▶ page 28])
Max. relative air humidity	80 % RH (-20 ... 31 °C), linearly decreasing down to 50 % RH at 55 °C, non-condensing
Operating conditions	To be used inside buildings in dry environments
Storage (remove the batteries from the device)	
Ambient temperature	-20 ... 60 °C (do not permanently expose the device to sunlight)
Max. relative air humidity	80 % RH

Table 23: Technical data

8 Disposal and environmental protection



At the end of product life, dispose of the unserviceable device and the batteries via appropriate collecting facilities provided in your community.

Index

Numerical

4 - 20 mA DC current loop (%)	28
5 V logic-level frequency ranges	30

A

AC ranges (A-AC)	28
AC voltage ranges (HFR V-AC)	27
AC voltage ranges (V-AC, V-AC+DC)	26
Accessories	15

B

Basic knowledge	7
Battery	
Replacing	44
BENNING MM 7-2	7

C

Calibrating	44
Capacitance measurement	37
Capacitance ranges	30
Cleaning	43
Continuity test	29
Continuity testing	36
Copyright	2
Current measurement	35

D

DC ranges (A-DC)	28
DC voltage ranges (V-DC)	27
Device	
Calibrating	44
Cleaning	43
Securing	13
Device structure	17
Digital display	19
Diode test	29
Diode testing	37
Disclaimer	2, 12
Display illumination	21
Disposal	47
Documentation	2

E

Environmental protection	47
External conductor testing	41

F

Frequency measurement	34, 35
Frequency ranges	30
Function	

A-HOLD	23
AutoV	24
Further setting options	25
HFR (AC)	21
HOLD	23
Hz	22
LoZ	24
Measuring range	24
MIN MAX	21
PEAK	22
Relative value	23
Selecting	20
Voltage indicator	22
Further information	7
Fuse	
Replacing	45

H

History	8
Holder of rights	2

I

Intended use	12
--------------	----

J

Jack control	24
--------------	----

K

Key	
Blue	20
HOLD	23
Hz	22
MIN MAX	21
PEAK	22
RANGE	24
REL Δ	23
VoltSense	22

L

Logic-level duty cycle	31
Low-pass filter	21

M

Mains frequency ranges	30
Maintenance	42
Maintenance schedule	42
Manufacturer	2
Measurement	
Requirements	32
Measuring accuracy	26
Measuring ranges	26

4 - 20 mA DC current loop (%)	28	Test	
5 V logic-level frequency ranges	30	Requirements	32
AC ranges (A-AC)	28	Trademarks	8
AC voltage ranges (HFR V-AC)	27		
AC voltage ranges (V-AC, V-AC+DC)	26	V	
Capacitance ranges	30		
Continuity test	29	Voltage indicator	39, 41
DC ranges (A-DC)	28	Practical tip	40
DC voltage ranges (V-DC)	27	Voltage measurement	34
Diode test	29	Voltage ranges (LoZ, AutoV)	27
Logic-level duty cycle	31	Voltage-free	42
Mains frequency ranges	30		
Resistance ranges	29	W	
Temperature ranges	31		
Voltage ranges (LoZ, AutoV)	27	Warning system	10
MM 7-2	7	Warranty	12
N			
Non-discrimination	2		
O			
Operation	32		
P			
Phase testing	39, 41		
Purpose of the operating manual	8		
R			
Rear panel of the device	17		
Resistance measurement	36		
Resistance ranges	29		
Return address	9		
Returns management	9		
Rotary switch	18		
S			
Safety measuring lines			
Connecting	33		
Scope of delivery	15		
Securing	13		
Selecting a function	20		
Service & Support			
Technical support	9		
Standards applied	10		
Symbols			
Device	11		
Operating manual	11		
T			
Target group	7		
Technical data	46		
Technical support	9		
Temperature measurement	38		
Temperature unit	25		
Temperature ranges	31		

BENNING

BENNING Elektrotechnik und Elektronik GmbH & Co. KG
Münsterstraße 135 - 137
D - 46397 Bocholt
Phone: +49 2871 93-0 Fax: +49 2871 93-429
Internet: www.benning.de E-Mail: duspol@benning.de

The text and illustrations correspond to the state of technology at the time of printing. Subject to technical changes. No liability accepted for printing errors.