

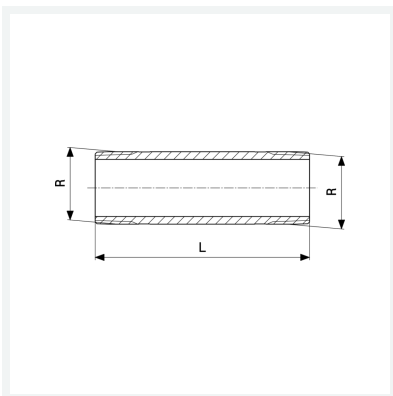

Langnippel
- R-Gewinde
Modell 3530

Artikel 267 438



Eigenschaften

Länge	L	150
Außengewinde kegelig	R	¾
Länge	L	150 mm
Gewicht	327,82 g	
Volumen	207,2 cm ³	
Werkstoff	Rotguss oder Siliziumbronze	