

DETTAGLIO A

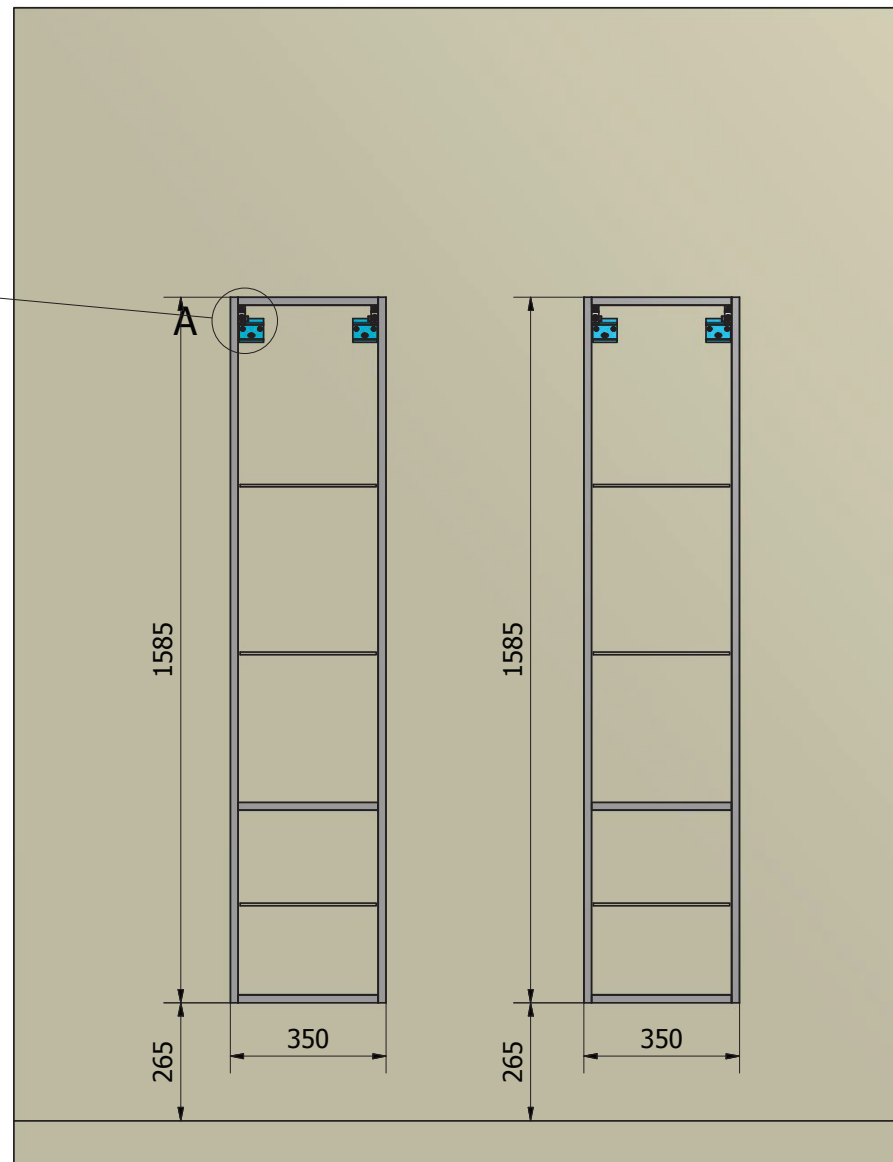
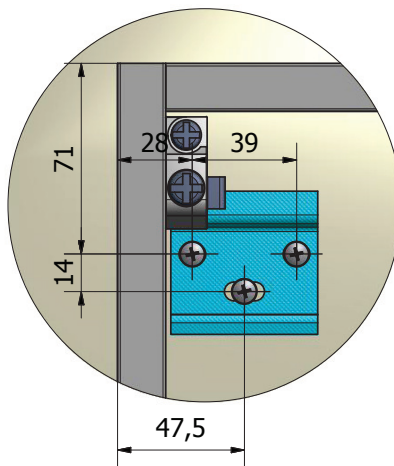

Crt.	Articolo	Descrizione	Peso	Qtà.
1	C161	COLONNA SOSP. 1 ANTA L.350 H.1585 P.370	37,077 kg	1
2	C163	COLONNA SOSP. 2 ANTE L.350 H.1585 P.370	37,099 kg	1